

2019

---

# JINR STRATEGIC PLAN ON NEUTRON RESEARCH IN CONDENSED MATTER AND NEUTRON PHYSICS

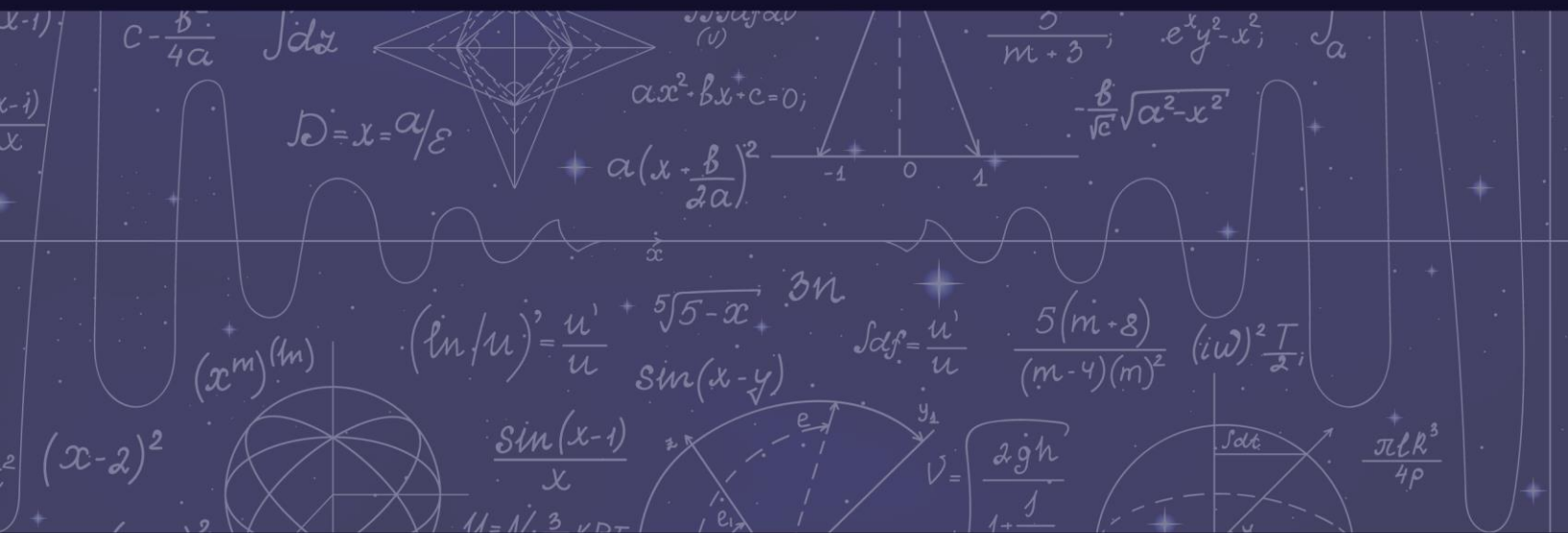

# **JINR Strategic Plan**

## **on Neutron Research in Condensed Matter and Neutron Physics**

Executive Summary.....	5
1. PRESENT STATUS AND TRENDS IN THE FIELDS OF RESEARCH, OPEN PROBLEMS IN WHICH JINR CAN OCCUPY ITS UNIQUE NICHE.....	10
1.1. Condensed Matter Research .....	11
1.2. Living matter.....	13
1.3. Bioscience .....	14
1.4. Nuclear Physics.....	15
1.5. Basic Research.....	16
1.6. Flagship experiments .....	17
2. WORLD NEUTRON LANDSCAPE AND A THE DNS-IV SOURCE .....	19
3. PRELIMINARY CONCEPTS OF A NEW NEUTRON SOURCE .....	25
3.1. IBR-3 .....	25
3.2. Moderators, neutron delivery system and instruments .....	27
3.2.1. Moderators.....	27
3.2.2. Thermal moderators.....	27
3.2.3. Cold moderators .....	27
3.2.4. Moderators for very cold neutrons .....	28
3.2.5. Source of ultracold neutrons.....	29
3.3. Neutron delivery systems.....	30
3.4. Instruments.....	30
3.4.1. IBR-2 instruments continuous upgrade and development.....	30
3.4.2. DNS-IV instruments development .....	31
4. PROJECT STATUS AND ROADMAP, RISK ASSESSMENT.....	31

4.1. DNS-IV roadmap.....	31
4.2. Placement and costs .....	32
4.3. Status of the project .....	34
4.4. Risk assessment .....	35
5. INTERACTION WITH OTHER FIELDS OF SCIENCE AND SOCIALLY SIGNIFICANT APPLICATIONS.....	36
6. TRAINING OF YOUNG SCIENTISTS AND SPECIALISTS .....	36
References: .....	36

## Abstract

Systematic shortage of the neutron beam time in Europe and in the world raises demand in construction of new neutron sources. We propose to build a new advanced neutron source, DNS-IV (Dubna Neutron Source IV-fourth generation), at JINR. To be constructed in the combination with modern moderators, neutron guides and neutron scattering instruments (DNS-IV) promises to become one of the best neutron sources in the world and will open unprecedented possibilities for scientists from JINR member states and worldwide for research in condensed matter physics, fundamental physics, chemistry, material and life science.

DNS-IV will provide shorter neutron pulses, however containing the same number of neutrons as at European Spallation Source (ESS, to be operational in 2024). Indeed, it will be as good as ESS for low-resolution experiments and significantly outperform it for high-resolution experiments.

Two alternative concepts of DNS-IV were considered: the pulsed neutron reactor IBR-3 with Np-237 core and the accelerator-driven spallation neutron source with PuO<sub>2</sub> core providing neutron multiplication factor of about 20-50. Both options have been under the feasibility study in N.A. Dollezhal Research and Development Institute of Power Engineering (NIKIET, Moscow). The final recommendation is based on such criteria as achievable neutron characteristics, nuclear safety, engineering complexity, timeline and expected costs. It was found that the engineering complexity of 2nd option makes its realization rather uncertain, both in time and costs. **Therefore, the pulsed neutron reactor IBR-3 with NpN fuel currently became the working project with the planned start of the DNS-IV operation is 2036-2037.**

First meeting with the specialists from A. A. Bochvar All-Russian Scientific Research Institute for Inorganic Materials (VNIINM) starts JINR-VNIINM cooperation aimed to the development of the roadmap for NpN reactor fuel fabrication.

## Executive Summary

Neutrons are used for studying fundamental symmetries and interactions, structure and properties of nuclei, but nowadays neutrons are mostly required in investigations of condensed matter including solid states, liquids, biological systems, polymers, colloids, chemical reactions, engineering systems, etc. Thanks to their exceptional features, the neutrons in many ways are an ideal probe for investigating materials because of significant advantages over other forms of radiation used for studies of microscopic structure and dynamics.

The use of cold neutrons (wavelengths from 4Å to 20Å) in neutron scattering research allows for studies of nanoscale objects and becomes the current trend worldwide, particularly studies of nano-structured objects required by medicine and biology. At the same time, using very cold neutrons (VCN) with wavelengths from 20Å to 100Å one can approach new levels of measurement accuracy in several techniques, e.g. neutron spin-echo and reflectometry. Moreover, VCN are also a very promising tool for research in the field of particle physics and studies of fundamental interactions (e.g. measurements the neutron lifetime, search for neutron-antineutron oscillations, etc.). Ultracold neutrons (UCN) are the well-established experimental tool for research in the field of particle physics and fundamental interactions. Further increase in the intensity of UCN sources will allow both improving the accuracy of such experiments and significantly expanding the scope of the UCN's usage, for example, for studies of surfaces and thin films.

Considering the present-day tendency, after 2030 only five sources will be available including three currently operating facilities: ISIS (Didcot, UK), SINQ (PSI, Villigen, Switzerland), FRM II (TU Munich, FRG), and two new sources (ESS (Lund, Sweden) and steady-state reactor PIK (PNPI NRC KI, Gatchina, Russia), both under construction with the start of operations planned for 2023-2024.

Thus, the need for a next-generation high-flux neutron source is driven by a growing interest in neutron investigations against the background of a steadily decreasing number of neutron sources in the world, as evidenced by the analysis of a specially established ESFRI "Physical Sciences and Engineering Strategy Working Group". Such a new source will in a great extent compensate the losses of the neutron beam time in Europe and attract users that are currently served at ILL and medium-flux reactors in Germany, France and Hungary.

**We propose to build a new advanced neutron source DNS-IV at JINR.** To be constructed in the combination with modern moderators, neutron guides and neutron scattering instruments, DNS-IV promises to be one of the best neutron sources in the world and will open unprecedented possibilities for scientists from JINR member states and worldwide for research in condensed matter physics, fundamental physics, chemistry, material and life science.

Being built in Russia, such a new very intense neutron source of the fourth generation will allow for the realization of the challenging research program and warranty the scientists from JINR member states the long-term access to the one of the most advanced neutron sources in the world.

**DNS-IV will provide shorter (0.3 ms against 2.8 ms) neutron pulses than ESS,** however containing the same number of emitted neutrons as at ESS, having peak neutron flux density approximately ten times higher than at ESS. Indeed, it will be as good as ESS for low-resolution experiments, however **outperform parameters of high-resolution instruments and options at the ESS.** DNS-IV will be complementary to the high-flux PIK reactor, so that the tandem of these two sources using the whole spectra of neutron scattering methods will provide unique possibilities for research both in traditional fields and in new ones, e.g. living matter. It is especially important for nuclear physics, the scientific basis for nuclear power engineering.

**JINR is the most appropriate place for a new source** due to the long-term development of neutron research here and the presence of the highly qualified and experienced scientific, engineering and technical personal.

Though the decision to build the pulsed neutron source is justified, we considered **two possible technical solutions:**

1) **The IBR-3 facility** that follows the traditional concept of JINR, originating from the construction of the IBR in 1960. This high-intensity pulsed neutron source will be constructed on the basis of a periodically pulsing fast-neutron nuclear reactor with the Np-237 active core. Powerful fission pulses (and, correspondingly, fast neutron pulses) will be produced in the reactor core by the modulator of reactivity during a short period of time, when the reactor is supercritical for the prompt neutrons.

2) **The spallation neutron source with subcritical assembly.** The spallation reaction caused by the collision of the high-energy protons with neutron-rich nuclei results in the much higher neutron

yield than the fission reaction. The idea for DNS-IV is to use the accelerator with reduced power, however to compensate the losses of the neutrons by their multiplication (neutron multiplication factor of about 20-50) in the subcritical assembly made of the of Pu-239 dioxide.

Both options have been under the feasibility study in N.A. Dollezhal Research and Development Institute of Power Engineering (NIKIET, Moscow). The final recommendation is based on such criteria as achievable neutron characteristics, nuclear safety, engineering complexity, timeline and expected costs. It was found that the engineering complexity of 2nd option makes its realization rather uncertain, both in time and costs. Therefore, **the pulsed neutron reactor IBR-3 currently became the working project with the planned start of the DNS-IV operation is 2036-2037.**

It is important to note, that the construction work at the new source will be carried out without phasing out the IBR-2, so that the commissioning of the new source should take place during the final operation years of IBR-2. This will allow new technical and instrumental decisions to be tested at neutron beams of IBR-2 and ensure the continuous access to neutrons for scientists from the JINR member countries.

### **Moderators and neutron delivery systems**

The development of the concept of modern neutron moderators and neutron delivery systems based on the latest developments in this field in JINR and ESS is essential for achieving record neutron fluxes at instruments, that can assure the maximal use of the spatial and time structure of the delivered neutron beams.

Fission or spallation neutrons with high energies of a few MeV are not usable for purpose of neutron investigations and will slow down till energies of thermal motion of atoms. Depending on the temperature of the moderator, the neutron spectra can be cooled down to the energies of thermal motion of atoms, 0.02 eV (thermal neutrons) or even lower, to (1-5) meV (cold neutrons) and 0.1  $\mu$ eV (very cold and ultra-cold neutrons).

The most effective **thermal grooved moderators** will be used at DNS-IV. **Cold moderators** will use low temperature cryogenic liquids (hydrogen or deuterium) or solid materials (methane and mesitylene) cooled to cryogenic temperatures. Over the past seven years, the IBR-2 at

the JINR FLNP has gained extensive experience in the use of mesitylene as a cold moderator material.

In all cases the use of grooved moderators in coupled geometry instead of a plane moderator increases the yield of neutrons by a factor of two.

A new **low dimensional cold moderators** with three times increased brilliance of the emitted neutron beams, that have been developed within last few years, will allow for the tripling the intensity at the neutron instruments that operates with highly collimated neutron beams (SANS diffractometers and reflectometers).

Effective **VCN moderator** will be based on new technologies - effective VCN production, optical systems for the VCN extraction and will be tested at the reactor IBR-2.

At present there are **no UCN sources** that use the pulsed time structure of the neutron source, so that the productivity of all modern UCN sources is determined by the average flux density. Meanwhile, it is already shown theoretically that the UCN density can be significantly increased and approach one corresponding to the peak power rather than the mean power of a pulsed neutron source. Such UCN source that will provide the unprecedented density of UCN will be developed within the scope of the present project.

### **Neutron delivery system and instruments**

The most efficient geometries of neutron guides - elliptic, parabolic and ballistic - will be used to minimize the losses and to tailor the phase space of the neutron beams according to individual requests of instruments. Such neutron guides will delivery to the samples only “useful” neutrons, thus maximizing the intensity at the samples, when minimizing the background of undesirable neutrons. A smart design of neutron instruments will benefit from the time structure of the pulsed neutron source and allow for simultaneous measurements over a wide energy and angular ranges of scattered beams. The performance of each instrument will be thorough simulated by established simulation packages (McStas and VITESS) in the iterative procedure aiming the optimization of instrument geometries and design for achieving the world-class performance.

Some of neutron instruments will profit a lot from the access both to thermal and cold neutrons. This will be accomplished by a specific design of in-pile parts of neutron guides that will “see” both cold and thermal moderators thus allowing for the bi-spectral beam extraction.



## **IBR-2 instruments continuous upgrade and development**

In a period 2020 – 2037 the IBR-2 instruments will be continuously upgrade and developed, providing new ideas for the DNS-IV instrumentation – moderators, neutron delivery system and instruments itself. What is important that the IBR-2 pulse duration is very close to the planned DNS-IV one, so many solutions for neutron guides, choppers etc. could be transferred directly to the DNS-IV.

## **DNS-IV project risk assessment**

Though results of feasibility study carried out by NIKIET ensuring us that the desired neutron flux density can be achieved using Np-237 fuel for DNS-IV, there is a risk associated with the fuel production technology.

To minimize this risk, we have already established working relations with A.A. Bochvar All-Russian Scientific Research Institute for Inorganic Materials (VNIINM) that will prepare the roadmap on the NpN fuel fabrication (with technical and economical estimations) at the stage of conceptual design.

The back-up solution is the use of plutonium oxide fuel (as at the operating IBR-2 reactor).

## **Project costs and operating costs**

Project costs for the IBR-3 construction are currently estimated as 370 M€. Final and more precise estimate will be made at the preliminary design stage by the end of 2022 (see roadmap, Figure 12).

The annual operating costs are estimated on the basis of exploitation experience of the IBR-2 reactor. The estimate amounts to 2-3 M€ including 150 staff and power consumption costs.

## **1. PRESENT STATUS AND TRENDS IN THE FIELDS OF RESEARCH, OPEN PROBLEMS IN WHICH JINR CAN OCCUPY ITS UNIQUE NICHE**

Neutrons are used for studying fundamental symmetries and interactions, structure and properties of nuclei, but nowadays neutrons are mostly required in investigations of condensed matter including solid states, liquids, biological systems, polymers, colloids, chemical reactions, engineering systems, etc. What mainly underpins our present-day quality of life depends upon our understanding and consequent control of the behavior of materials. Thanks to its exceptional features, neutron in many ways is an ideal probe for investigating materials, having significant advantages over other forms of radiation used for studies of microscopic structure and dynamics. Zero electrical charge allows neutrons to penetrate materials deeply, up to few ten cm (cf. with a few micrometers for the synchrotron radiation). The anomalously large inherent magnetic moment allows them to reveal the dynamic and structure of microscopic magnetic structures at the same time. Neutron beams with wavelength around  $2\text{\AA}$ , that corresponds to typical atomic distances and have energies equivalent to the temperature of the sample, are ideally suited to investigations of atomic structures and observations of atomic movements. Furthermore, neutrons can distinguish between different isotopes of the same chemical element that leads to unique contrast for different materials in complex environments. For example, in contrast to X-rays, hydrogen is visible even on the background of heavy atoms and the exchange of hydrogen by the chemically equivalent deuterium can be used to label different sections in very complex biological macromolecules

Nobody can predict scientific challenges 20-30 years ahead. We can, however, extrapolate from the present and foresee where major advances might be possible. A general scheme of participation of neutron investigations in the process of interaction of science with various branches of the economy is presented in Figure 1. This scheme is, of course, idealized and suggests that science nourishes technologies with its discoveries, and the economy poses challenges to science. In reality, science develops according to its own laws and problems arise naturally with the development of the experimental base, and our understanding of the laws of Nature. Nevertheless, in the organization of activities of large research centers based on mega-facilities, this scheme should be taken into consideration.

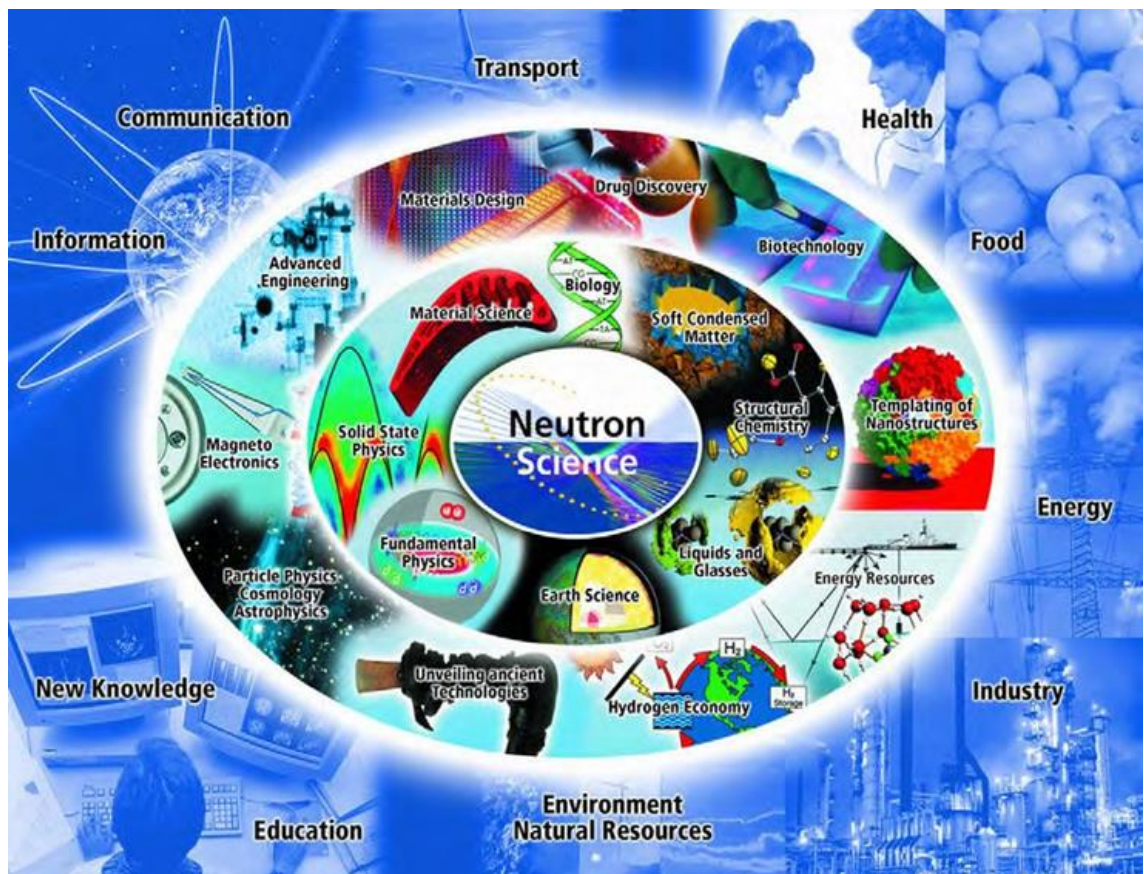

*Figure 1: The science around modern high flux neutron source incorporates both fundamental and applies research*

Below, we consider some scientific problems, for the solution of which we need advanced neutron sources with outstanding parameters (for more details see [1]).

### **1.1. Condensed Matter Research**

Nowadays, more than 90% of extracted neutron beams are used for condensed matter research related to a wide variety of scientific fields such as solid-state physics, soft matter (complex liquids, non-crystalline solids, polymers), chemistry, molecular biology, materials sciences and engineering sciences. New fields of research are constantly emerging. For example, one can mention the recently growing interest in the structure and properties of food and objects of cultural heritage. Over the past years, several new problems have appeared in all mentioned sciences where neutron scattering can provide very useful information on the structure and dynamics. Practically every new phenomenon and new material (especially in solid state physics) is probed by neutrons at a very early stage of research. For example, a lot of possibilities are opening in the use of isotope substitution as illustrated in the picture.

Slow neutrons ( $\lambda = 0.1 - 4 \text{ nm}$ ) are an ideal technique for nanodiagnostics of hydrogen-containing systems

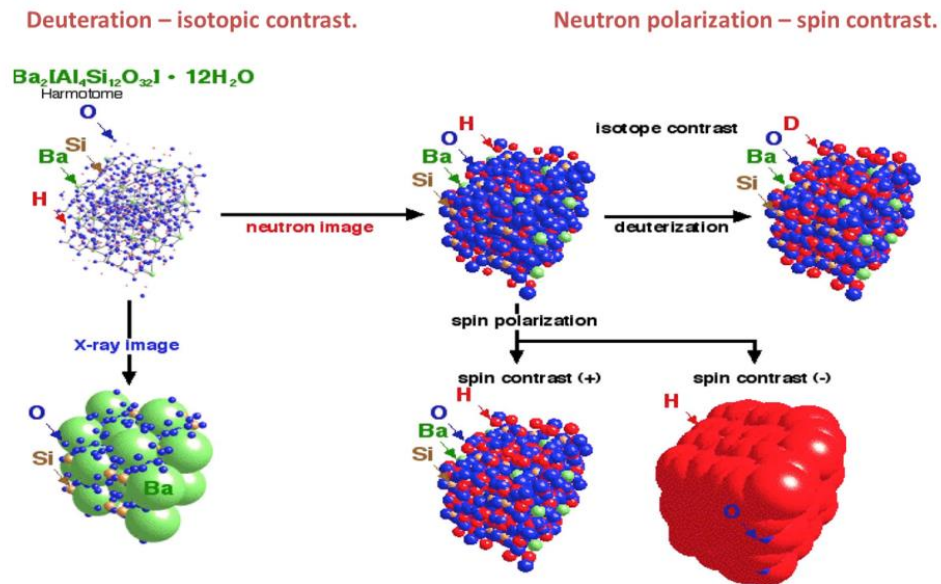

**Figure 2: neutron sensitivity to the magnetic structure and isotopic contrast provides much more information compare to X-rays**

A special role in the study of condensed matter is played by polarized neutrons, which provide much more detailed information about the structure of matter not only in inorganic magnetic materials (as can be seen from the schematic drawing) but also in biological objects. In this case, the use of polarized neutrons makes it possible to enhance the contrast of the structure image, which is an important complementary technique to the widely used isotopic contrast method. The figure shows the difference in the small-angle neutron scattering spectra in magnetic colloids using polarized and non-polarized neutrons.

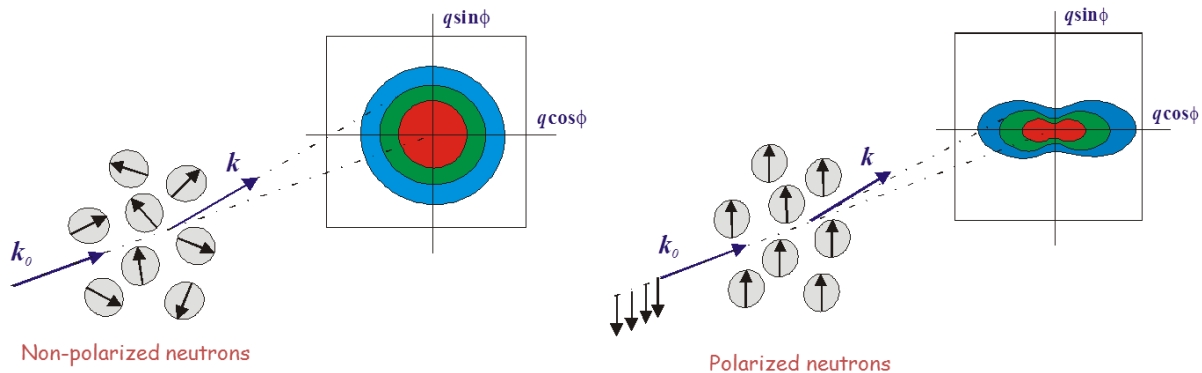

**Figure 3: small angle scattering of the nonpolarized and polarized neutrons**

Being a system with an infinite number of degrees of freedom like the particle world, condensed matter is a permanent source of new phenomena. From this point of view, the main strategy of any user research center based on a large facility consists of the development and construction of advanced experimental techniques and instruments to be ready for new challenges and to offer scientists from different research centers new possibilities for their studies. The construction of a new-type pulsed neutron source in Dubna in 1960 led to the appearance of several new experimental techniques. For example, time-of-flight (TOF) neutron diffractometry that was born in Dubna in 1963 [2] was further developed in many neutron centers including FLNP. The High-Resolution Fourier Diffractometer (HRFD) and Real Time Diffractometer (RTD) at the IBR-2 reactor are remarkable examples of the realization of TOF neutron diffractometry [3]. Both instruments will provide much more possibilities being installed at a neutron source that will be more intense than the IBR-2 reactor. A very important method, inelastic neutron scattering, is very difficult for implementation at IBR-2. Investigations of atomic and molecular dynamics are an important tool for neutron scattering, and for full-scale experiments a neutron flux of one order higher than that at IBR-2 is crucial. Nowadays, small-angle scattering and reflectometry are becoming more and more popular; FLNP was among the leaders in the realization of these methods.

## **1.2. Living matter**

During the last decades the focus of modern research has shifted towards the study of soft matter with attempts to investigate living matter. Living matter is the most complicated and interesting subject for the modern science. Living systems have a number of specific features. They have long-living, slow-relaxing structures, which are far from equilibrium; another important property is the irreversibility of many processes. We can explore some features of living matter such as kinetics, structure hierarchy, self-assembly by studying soft matter. Therefore, one of the main directions of the research programme for a new neutron source could be related to the study of soft and living matter and key problems of biophysics with application in biomedicine and pharmacology, which is in line with the modern trends in the world science.

In fact, this field of research is at the limits and in some cases even beyond the possibilities of present-day physics. In this respect, we need the advanced development of all experimental techniques, which are available now.

## Current challenge: from solids to soft and living matter

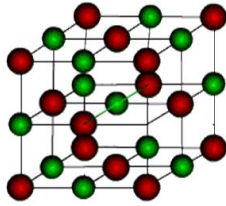

### Solid Matter

Crystalline Solids  
Amorphous Solids  
Quasicrystals  
Low Dimension  
Structures

- fluctuations
- relaxation

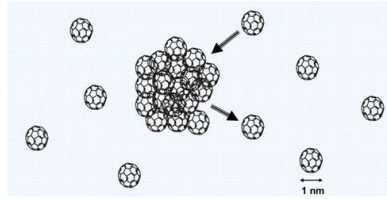

### Soft Matter

neither simple liquids  
nor crystalline solid

- length scale intermediate  
between atomic size and  
macroscopic scales
- kinetics, self-assembly
- hierarchy

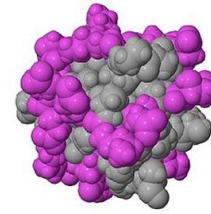

### Living Matter

Nuclear Acids (DNA, RNA)  
Proteins, Polysaccharides  
Membranes

- long-living, slow-relaxating  
structures
- self-organization
- irreversibility

Figure 4: neutrons are providing us the bridges from solid to soft matter and later to the living one

### 1.3. Bioscience

In the 21st century, bioscience will become one of the most rapidly developing areas of research, providing solutions to major challenges facing humankind. Today, we have considerable progress in deciphering the nature and the origin of problems concerning human health. One of the most important approaches is to make use of techniques that allow scientists to “see” the structure and dynamics of biologically significant materials at the atomic and molecular scale in the ideal case under conditions as close to physiological as possible. There are several complementary methods – X-ray and neutron scattering, nuclear magnetic resonance (NMR) and electron microscopy which are used together to determine the shape and internal structure of bioactive molecules such as proteins, as well as to understand the mechanisms of their functioning. By using X-ray crystallography, one can determine the positions of atoms in very small crystals containing large numbers of identical proteins. NMR methods allow one to obtain three-dimensional structures of proteins in solutions or in solid environment. Also, cryoelectron microscopy gives images of the overall shape of large complexes of biological molecules due to the possibility of measurements in water, the natural media for life objects.

Neutrons, like X-rays, reveal a microscopic structure through the scattering from the ensembles of atoms in a sample. Though neutron beams are much less intense than X-ray beams produced at large-scale facilities and neutron crystallography requires larger samples than in analogous X-ray experiments, nevertheless neutron methods play a unique role in life and health sciences, because neutron nicely “see” hydrogen even in the environment of heavy atoms just in contrast to X-rays where hydrogen is practically invisible at the background scattering of much heavier atoms.

**However, the use of the unique neutron probe is currently limited by a low intensity of neutron beams that leads to the requirement of relatively large samples and limits the magnitude of the effects under investigations. A more intense neutron source will allow for studies of much smaller objects and/or much weaker effects, thus opening completely new scientific opportunities.** Some of them are listed below:

- *In solid state physics*: nanocrystals, low-dimensional systems, magnetism and superconductivity.
- *In chemistry: in situ* real-time measurements for synthesis of novel materials.
- *In Earth and environmental sciences*: structural studies of complex minerals at high temperatures and high pressures for the understanding of basic geological processes.
- *In engineering sciences*: nondestructive control of engineering products and machine components to improve industrial technologies.
- *In soft matter research*: structural and real-time studies of polymers, colloids, liquid crystals, nanoliquids for a lot of industrial processes.
- *In biology and biotechnology*: structural studies of macromolecular complexes, kinetic measurements during DNA synthesis, drug design and delivery, etc.

#### **1.4. Nuclear Physics**

Since its emergence, neutron nuclear physics has demonstrated its effectiveness, becoming the basis of nuclear power engineering and a tool for studying the nuclear structure and properties of fundamental interactions. The tasks that this area of research faced in the early 21st century (V.L.Aksenov, *Particles and Nuclei* 31 (6), p. 1303 (2000)) are still of particular importance. They echo the questions that were formulated by the international scientific community when discussing the prospects for the development of nuclear physics (NuPECC, Long Range Plan 2017). High-

precision determination of neutron properties, parameters of its decay and neutron cross sections, studies of neutron-induced fission and nuclear reactions with neutrons are valuable and sometimes unique sources of information for solving cosmology problems, studying the properties of the universe at an early stage of its formation, properties of nuclear matter and fundamental interactions. Nuclear neutron methods (such as activation analysis) have found wide applications as a powerful analytical method in environmental, biological research and archeology. These methods are widely known to be used to study the surface of planets of the Solar System. The application of these methods in several industries holds much promise. The study of cross sections for interactions of neutrons with nuclei for the needs of nuclear power engineering is still of considerable significance. Nuclei are collections of protons and neutrons. This can be plotted on a kind of nuclear landscape with a long valley of stability. On either side of the valley of stability are areas inhabited by unstable nuclei with an increasing number of protons and neutrons. These areas are bounded by the so-called driplines. It is known where the proton dripline is, but only the lower part of the neutron dripline has been investigated so far. Studies of extreme nuclei provide stringent tests for nuclear models and also for the theories of underlying nuclear forces. Nuclei with high proton-to-neutron ratios can be obtained relatively straightforwardly with the help of accelerators. The obtaining of neutron-rich nuclei is more difficult, and only few facilities worldwide can produce their reasonable amounts.

Neutron-rich nuclei located close to the r-process path can be created by nuclear fission. The fission itself is also a rich source of information: the abundances of fission fragments produced, and their excited states depend on the nuclear structure. A high-flux neutron source can provide very exotic neutron-rich nuclides with very high production yields. The pathway of the r-process can be determined by mass measurements for a set of these nuclides.

## 1.5. Basic Research

The discovery of the Higgs boson opens a new era in physics. The established theory describing weak, strong and electromagnetic interactions of all known particles is the Standard Model (SM) of particle physics. However, it does not seem to be a complete theory. What is new physics beyond SM? In this respect, precision experiments with low-energy neutrons can provide a great deal of new information. For example, the discovery of neutron-antineutron ( $n\bar{n}$ ) ( $n\bar{n}$ )oscillations could answer crucial questions of particle physics and cosmology. Why do we observe more matter than antimatter in the Universe? Another related intriguing subject potentially



accessible with this process concerns the mechanism responsible for neutrino mass generation. A high neutron flux combined with the progress made in neutron optics offers a remarkable opportunity to perform a sensitive experiment dedicated to search for such oscillations. The next flagship experiment could be direct measurement of neutron-neutron cross section. Very intriguing perspectives are arising in experiments on the problem of quantum measurements.

The extensive field of research is opened with the use of UCN. Traditional attempts are related to new physics beyond the SM through measurements of neutron lifetime  $\tau_n$  and electric dipole moment (EDM). However, it seems that recent observations of UCN quantum states in a gravitational field have much prospect. Indeed, it is a new research field including the investigation of dark matter and dark energy and especially precise measurements of structure and dynamics of surfaces at nanoscale.

UCN physics is traditional for FLNP. Note that UCN have been discovered in FLNP by F.L.Shapiro's group in 1968. FLNP scientists are taking part almost in all leading experiments with UCN in the world and have a few new ideas to be implemented at a new more intense neutron source.

### **1.6. Flagship experiments**

Several research areas mentioned above have a relatively long history and impose high requirements for the parameters of the neutron source, primarily for the high neutron intensity. The increase in intensity makes it possible not only to improve the rate of statistics collection, but also to study systematic effects at a new level, which is an important factor for high-precision experiments. New prospects for increasing the accuracy of experiments are also associated with the possibility of creating high-intensity sources of ultracold neutrons and very cold neutrons on the new neutron source. In combination with the pulsed mode of operation of the source, this opens up new methodological possibilities, for example, for measuring the neutron lifetime. At the stage of developing the source, a number of design solutions can be built in, which will allow measurements to be carried out in the optimal geometry (neutron-neutron scattering, neutron-antineutron oscillations) and during the construction of the source the necessary infrastructure can be prepared (for example, devices for polarization of nuclear targets and neutrons) [4, 1].

In conclusion, we will formulate in a short form scientific opportunities with the DNS-IV pulsed neutron source:

<i>Investigations</i>	<i>Expected results</i>
Structure and dynamics of soft and biological systems with high flux and polarized neutrons	Primary and tertiary structures Intramolecular dynamics Bioenergetics of a cell Biomedicine and pharmacology
Crystal and magnetic structure with high resolution and real-time diffraction at high pressure and magnetic fields	New functional materials
Neutron-antineutron oscillations Dark matter and dark energy with UCN New Quantum phenomena with neutrons	Beyond the Standard Model New Physics New aspects of quantum mechanics and consciousness
Neutron-rich nuclei at isotope separator on-line system with neutrons, fission	Nuclear "Standard Model"
Irradiation, isotopes	Radiobiology, medicine

*Figure 5: Flagship research directions for the DNS-IV*

## 2. WORLD NEUTRON LANDSCAPE AND A THE DNS-IV SOURCE

The need for a next-generation neutron source is driven not only by the development of neutron research in JINR, but also by a growing interest in these investigations against the background of a steadily decreasing number of neutron sources in the world, as evidenced by the analysis of a specially established ESFRI Physical Sciences and Engineering Strategy Working Group.

The following two schematic figures (Figure 6 and Figure 7) after Th. Brückel from Jülich Forschungszentrum illustrate the changing European landscape of neutron sources.

### European Largest Neutron Centers 2018

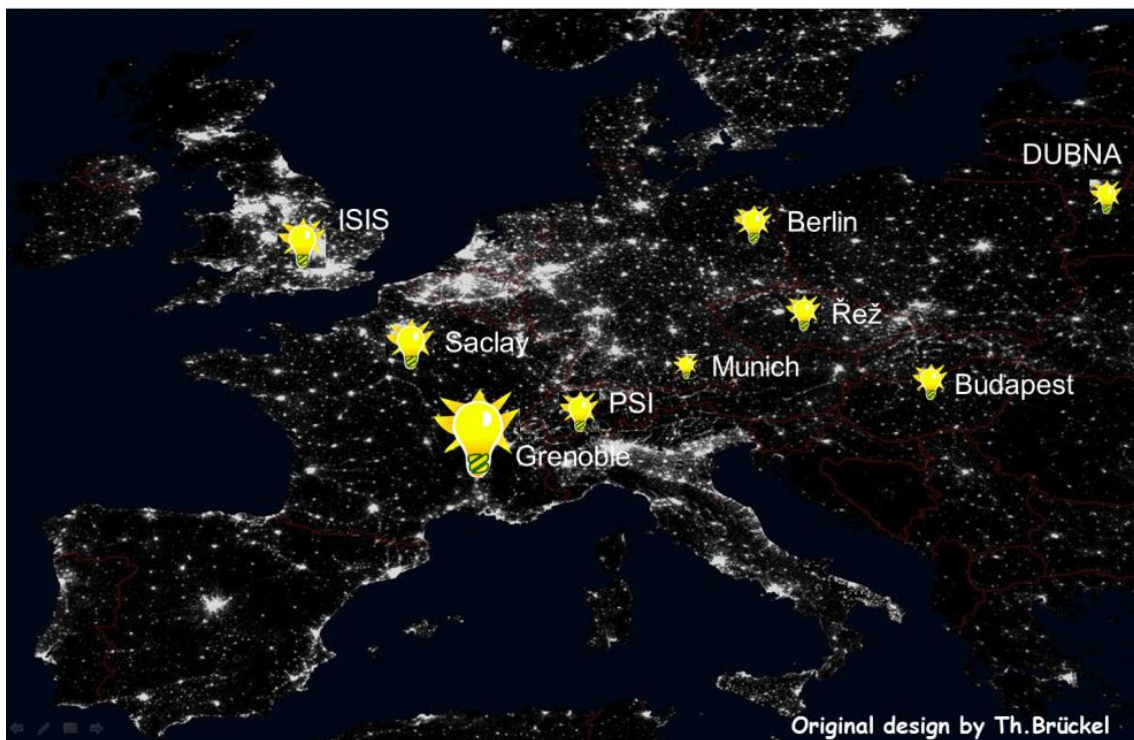

*Figure 6: European neutron landscape in 2018*

## Possible Neutron Scenario for Europe after 2032

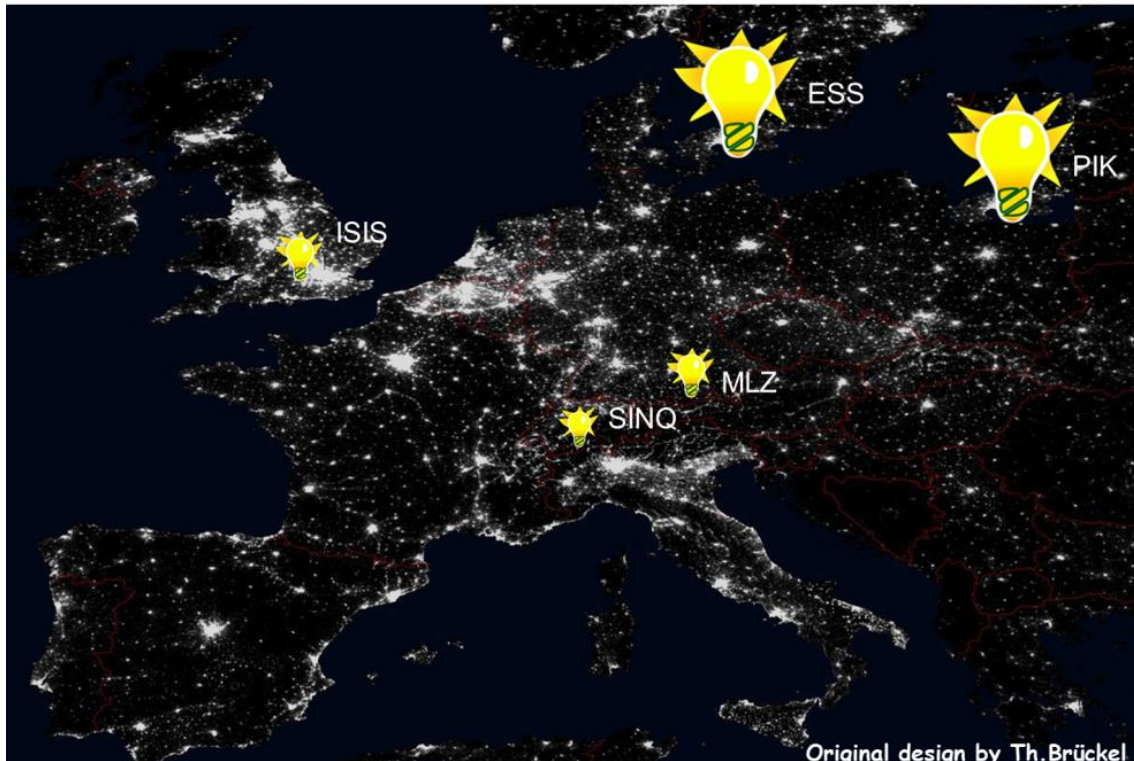

*Figure 7: An optional European neutron landscape after 2032*

In Europe, there are only ten leading neutron centers with a developed user systems [Table 1]. Considering the present-day tendency, after 2030 only five sources will be available including three currently operating facilities: ISIS (Didcot, UK), SINQ (PSI, Villigen, Switzerland), FRM II (TU Munich, FRG), and two new sources (ESS (Lund, Sweden) and steady-state reactor PIK in the Petersburg Nuclear Physics Institute of the National Research Center “Kurchatov Institute” (Russia)) which are under construction at the moment. Over the last years this situation has sparked lively discussions on new neutron sources in Europe. A medium-power source (which is much cheaper compared to ESS) based on a deuteron linear accelerator with a Be target has recently been proposed to be constructed at the Jülich Research Center. Similar sources for Saclay and Bilbao are under consideration.

**Table 1: Advanced neutron sources within the European strategy on neutron scattering [5]**

Source	Commissioned, year	Thermal power, MW	Average neutron flux, $\text{cm}^{-2}\text{s}^{-1}$	Peak neutron flux, $\text{cm}^{-2}\text{s}^{-1}$	Operation, days per year	Number of stations	Possible number of stations	Number of users per year	Operating costs, $10^6$ Euros
FRM II, Munich	2005	20	$8 \times 10^{14}$		240	23 in operation, 7 under construction	35	1000	55
BER II, Berlin	1991	10	$1.2 \times 10^{14}$		220	16 in operation	20	400	25
ILL, Grenoble	1975/1995	58	$1.3 \times 10^{15}$		200	27 + 10 CRG*	>40	1400	80+CRG
ESS, Lund	2019,planned	5, LP		$4 \times 10^{16}$	200	20 after 2025	>20		103
PIK, Gatchina	2019,planned	100	$5 \times 10^{15}$		200	22 after 2022	>40		30
LLB, Saclay	1985	14	$3 \times 10^{14}$		200	22	25	600	25
SINQ, Villigen	1996	1	$1.5 \times 10^{14}$		200	15	20	600	30
ISIS/ ISIS-II, Abingdon	1985/2009	0,2, SP		$4.5 \times 10^{15}$	180	34	41	1500	55
IBR-2, Dubna	1984/2012	2, LP		$2 \times 10^{16}$	108	14	14	200	1
WWR, Budapest	1959/1993	10	$2.1 \times 10^{14}$		140	14	14	100	10

\*CRG – abbr. for Collaborative Research Group instruments.

The Table 2 below shows only the world's leading pulsed sources as reference points.

**Table 2: The world leading pulsed sources [5]**

State, city	Name, start of operation/ refurbishment	Target power, MW	Neutron flux in pulse $10^{14} \text{cm}^{-2}\text{s}^{-1}$	Thermal neutron pulse duration, $\mu\text{s}$ ; frequency, $\text{s}^{-1}$	Averaged in time neutron flux $10^{12} \text{cm}^{-2}\text{s}^{-1}$	Number of beams/cold moderators	Experimental stations				
							Diffraction	Small angle	Reflectometer	Inelastic	Other
<b>England</b> Chilton	ISIS I, 1985 ISIS II, 2009	0,2	10 45	20÷30; 50 20÷30; 5	1,5 0,7	16/ 2 13/ 1	10 6	2 4	3 5	7 2	1 2
<b>USA</b> Los-Alamos	MLNSC, 1985	0,1	7	20÷30; 20	0,4 4	16/ 2 14/ 1	4	2	3	2	2
Oak-Ridge	SNA, 2006 STS, project	1 0,5	12 50	20÷50; 60 50÷200; 10	10		7	2	3	7	3
<b>Japan</b>											

Ibaraki	JSNS, 2009, plan	1	20/ 65	20÷50; 25	10/ 30	21/ 1	7	1	2	3	7
<b>China</b> Donguan	CSNS 2018, plan	0,1	~5	20÷50; 25	~1	20					
<b>Russia</b> Dubna	IBR-2, 1984/2012	2	60	310; 5	10	14/ 2	6	1	3	2	2
<b>Sweden</b> Lund	ESS 2019, plan	5	50÷75	2800; 14	200÷300	16/ 1 first phase	5	2	2	6	1

The need for a next-generation neutron source is driven by a growing interest in these investigations against the background of a steadily decreasing number of neutron sources in the world, as evidenced by the analysis of a specially established ESFRI Physical Sciences and Engineering Strategy Working Group [6].

To balance the world neutron landscape, one more intense pulse neutron source of the fourth generation is needed in Russia. For the advanced research programme outlined in the previous Sec., we need the following parameters for the neutron flux density: in pulse  $\Phi > 10^{16} \text{ cm}^{-2} \cdot \text{s}^{-1}$  and averaged in time  $\Phi > 10^{14} \text{ cm}^{-2} \cdot \text{s}^{-1}$ .

The pulsed neutron sources discussed above are used mainly for neutron scattering as we can see in the Table. Remember that neutron sources for beam research can be either steady-state (mostly reactors) or pulsed (mostly accelerators). The latter sources vary in pulse width:  $\Delta t < 10 \mu\text{s}$ , (very short pulse),  $10 < \Delta t < 50 \mu\text{s}$  (short pulse),  $\Delta t > 100 \mu\text{s}$  (long pulse). For traditional neutron spectroscopy in nuclear physics where resonance neutrons are used, for the most part, very short pulses are needed. For neutron spectroscopy in condensed matter where thermal neutrons are used predominantly short pulses are required. The successful experience of the IBR-2 reactor operation ( $\Delta t = 320 \mu\text{s}$ ) has drawn the attention of neutron society to long-pulse sources (LPS). ESS, for example, will have  $\Delta t = 2800 \mu\text{s}$ . The main advantage of LPS is high neutron flux and, as a result, a possibility to perform not only scattering experiments on condensed matter but also experiments on fundamental physics and nuclear physics. We can conclude that a new neutron source will be particularly high in demand being a long-pulse source. For JINR with its IBR-2 experience a long-pulse source would be suitable. It would also be highly preferable to have a short-pulse option. In this case, all possibilities of neutrons can be used.

**Table 3: short pulse neutron sources for nuclear physics**

Neutron source (laboratory)	$\langle I_n \rangle, 10^{15}$ n/s	$\Delta t, ns$	$Q, 10^{30}$ n/s <sup>3</sup>	Number of instruments for nuclear physics experiments
LANSCE (LANL, USA)	10	1-125	0.64*	8 (total, partial cross sections) +ICE House test facility
n_TOF (CERN, Switzerland)	0.4	10	4	6 (total, capture, fission, scattering, (n, $\alpha$ ))
ORELA (ORNL, USA)	0.13	2-30	0.14*	5 (total, partial cross sections)
GELINA (IRMM, Belgium)	0.025	1	25	5 (total, partial cross sections)
GNEIS (PNPI, Gatchina)	0.3	10	3	3 (total, capture, fission) + ISNP/GNEIS test facility
IREN (JINR, Dubna, project)	1.0	400	0.0062	under construction

$\langle I_n \rangle$  – average intensity of neutrons emitted in  $4\pi$  solid angle;

$\Delta t$  – neutron pulse width;

$Q = \langle I_n \rangle / (\Delta t)^2$  – quality coefficient of the neutron source;

\* – present value corresponding to the maximum pulse width.

The problem of neutron sources is particularly acute in Russia. The diagram shows the neutron sources that can be used for research on extracted beams.

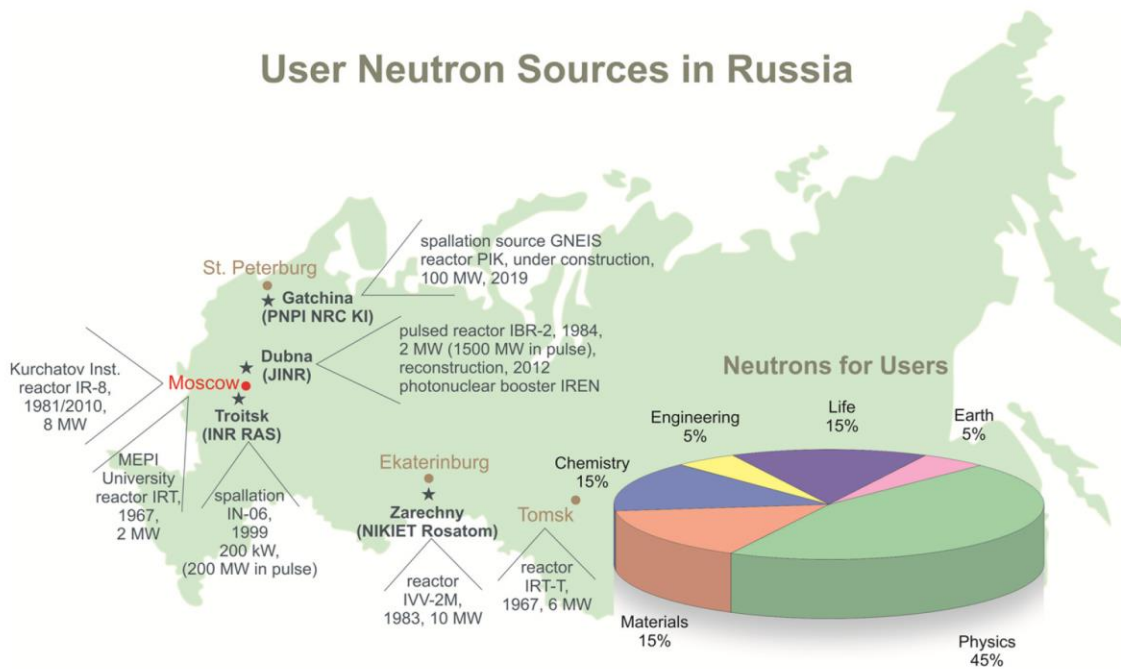

**Figure 8: User neutron sources in Russia**

At present, only the IBR-2 reactor is used in the format of international standards. After the IBR-2 reactor is put out of service, there will remain only one research reactor in Russia – reactor PIK in NRC “Kurchatov Institute” (Gatchina). Other sources will be decommissioned due to the expiration of their expected service life.

**Table 4: characteristics of neutron sources in Russia for studies with extracted beams**

Facility	Organization	Commissioned, year	Power, MW	Neutron flux, $10^{14} \text{ cm}^{-2} \text{ s}^{-1}$	Number of stations
IR-8	NRC KI, Moscow	1957/1981/2012	2/5/8	1	4 + 5
WWR-M reactor	PNPI NRC KI, Gatchina	1959/1978 Prolonged shutdown since 2016	5/18	4.5	12
WWR-Ts reactor	Branch of RIPC, Obninsk	1964	13	1	3
IWW-2M reactor	IRM, Zarechnyi	1966/1983	15	2	5
IRT-T reactor	RI TPI, Tomsk	1967/1977	6	1.2	–
IPT reactor	NRU MEPHI, Moscow	1967/1975 Prolonged shutdown since 2013	2.5	0.3	4
GNEIS (pulsed) $\Delta t = 10 \text{ ns}$	PNPI NRC KI, Gatchina	1973/1983	$3 \times 10^{-3}$	1	3
IN-06 sources (pulsed) $\Delta t = 100 - 200 \mu\text{s}$	INR RAS, Troitsk	1999	$3 \times 10^{-1}$	1	7 + 2
IREN (pulsed) $\Delta t = 100 \text{ ns}$	JINR, Dubna	2010	$4 \times 10^{-3}$	0.1	3
IBR-2 (pulsed) $\Delta t = 200 \mu\text{s}$	JINR, Dubna	1982/2011	2/2	100 (peak)	17
PIK reactor	PNPI NRC KI, Gatchina	2019, planned	100	45	22 after 2022

A new intense neutron source of the fourth generation is required on the territory of Russia. This source will be complementary to the PIK reactor as these two sources will give the possibility to use the whole spectra of neutron scattering methods in traditional fields of research as well as in new ones such as living matter research. It is especially important for nuclear physics, the scientific basis for nuclear power engineering. And Dubna is the most appropriate place due to the long-term development of neutron research here. Such a source erected at the JINR will replace IBR-2 and continue its tradition of the world class user facility for all JINR member states.



### 3. PRELIMINARY CONCEPTS OF A NEW NEUTRON SOURCE

#### 3.1. IBR-3

Fundamentally, the IBR-3 facility (NEPTUN) follows the traditional concept of JINR, originating from the construction of the IBR in 1960 - a high-intensity pulsed neutron source for physical research on the extracted beams is constructed on the basis of a periodically pulsing fast-neutron nuclear reactor [7, 8, 9]. Fission power pulses (and, correspondingly, fast neutron pulses) are produced by the modulator of reactivity in the reactor core during a short period of time, when the reactor is supercritical for the prompt neutrons. Slow neutrons are obtained by the slowing down of fast neutrons by external hydrogen containing moderators.

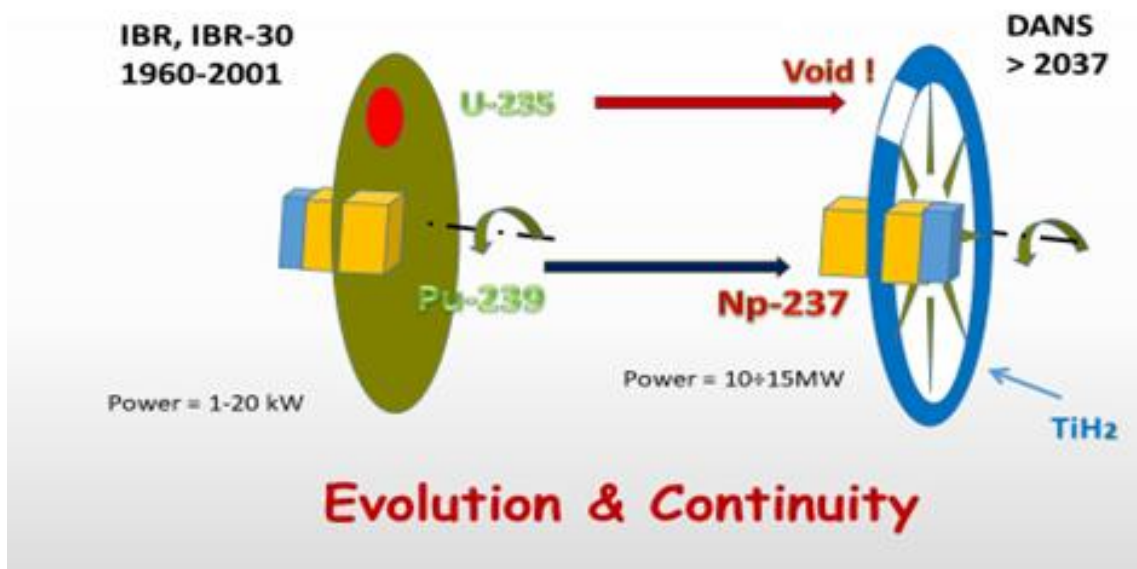

*Figure 9: from IBR-2 to IBR-3*

The differences between the IBR-3 (labelled NEPTUN) and IBR and IBR-2M reactors are as follows (see figures):

1. Neptunium (Np-237) nitride is proposed as nuclear fuel instead of Pu-239 (IBR) and plutonium oxide (IBR-2M);
2. The modulator of reactivity is a rotating disk stuffed with the titanium hydride over the entire periphery, except for an empty sector matching to the size of the reactor core. The

supercriticality is achieved when the empty sector passes between the two halves of the reactor core. This method of modulation of reactivity is much more efficient than the movable reflector as at IBR-2M;

3. Hydrogen-containing moderators are placed directly at the boundaries of the core and surrounded by the beryllium reflector;

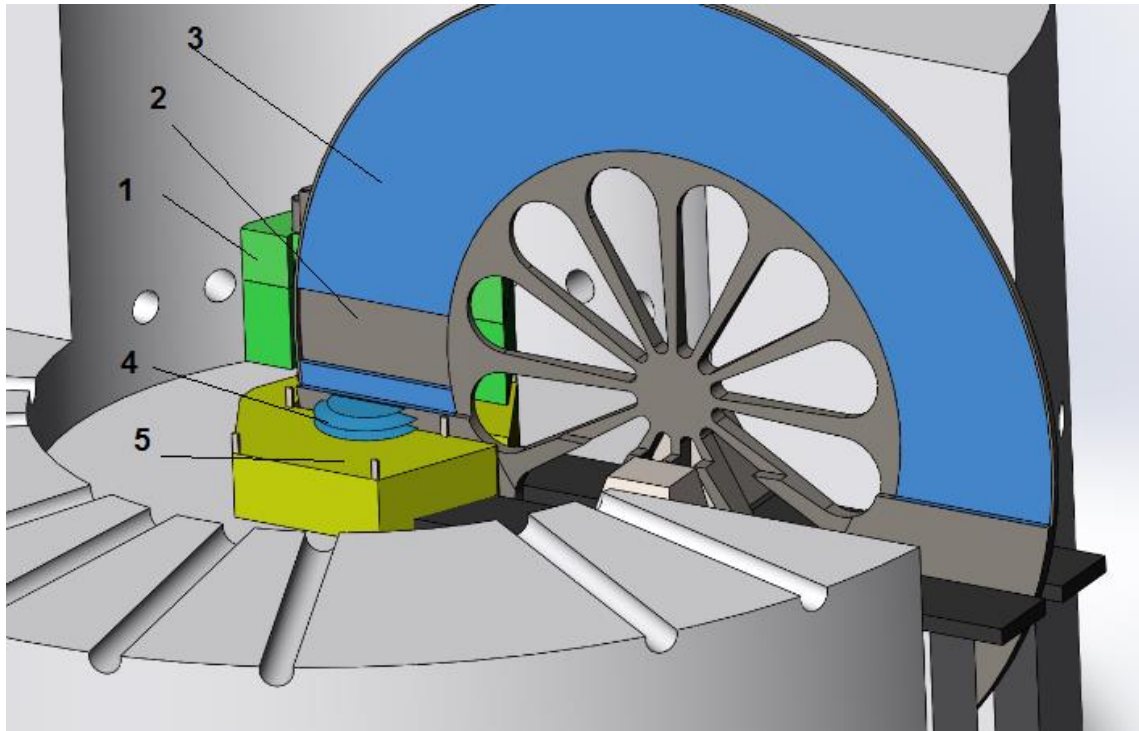

*Figure 10: schematic view of IBR-3; 1- reactor core reactor core, 2 - empty sector of reactivity modulator, 3 - reactivity modulator coated with titanium hydride coating, 4 - moderator, 5 - beryllium reflector.*

IBR-3 with the reactor thermal power of 10-12 MW and modified moderator placement geometry will provide by an order of magnitude higher neutron flux density, up to  $10^{14}$  n/cm<sup>2</sup>/s. Moreover, the neptunium (Np) loading of the reactor will allow for a significant, 3-4 times lower than at IBR-2, reduction of neutron background between pulses due to the threshold nature of the energy dependence of the Np fission cross section.

**N.A. Dollezhal Research and Development Institute of Power Engineering (NIKIET, Moscow) made a feasibility study of the NEPTUN reactor and found it possible to reach designed neutron flux density. Therefore, the pulsed neutron reactor IBR-3 currently became the working project with the planned start of the DNS-IV operation is 2036-2037.**

### 3.2. Moderators, neutron delivery system and instruments

In order to take the full advantage from a new high flux neutron sources it must be equipped with the most efficient transformers of neutron spectra (moderators), most efficient system for the extraction neutrons from the moderators and their delivery to neutron instruments and finally specially designed instruments that can assure the maximal use of the spatial and time structure of the delivered neutron beams (Figure 11).

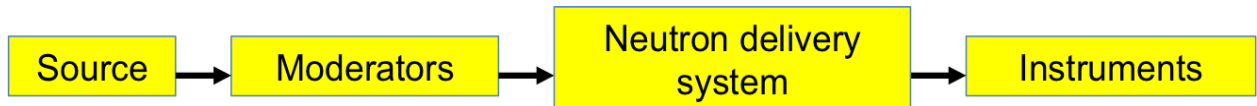

*Figure 11: schematic diagram of the neutron instrument on extracted beam*

#### 3.2.1. Moderators

Fission or spallation neutrons with high energies of about MeV or few MeV correspondingly are not usable for purpose of neutron investigations, so that they must be slow down till energies of thermal motion of atoms. This is achieved by neutron moderators, where high energy neutrons undergo multiple collisions with atoms of the moderator material and loosing energy till they are coming in the thermal balance with the moderator material. Depending on the temperature of the moderator, the neutron spectra can be cooled down to the energies of thermal motion of atoms, 0.02 eV or even lower, to 1-5 meV (cold neutrons) and 0.1  $\mu\text{eV}$  (very cold and ultracold neutrons).

The development of the concept of modern neutron moderators and neutron delivery systems based on the latest developments in this field in JINR and ESS is absolutely essential for achieving record neutron fluxes at instruments.

#### 3.2.2. Thermal moderators

The most effective moderators are grooved moderators that will be used at DNS-4.

#### 3.2.3. Cold moderators

Neutrons cooled down to cryogenic temperatures have wavelength above 4  $\text{\AA}$  and are requested for high-resolution angular measurements (SANS, reflectometry) and high-resolution

energy measurements (spectroscopy, neutron spin-echo). Cold moderators are generally exploiting low temperature cryogenic liquids (hydrogen or deuterium), but in some cases the solid materials are used. Solid methane and mesitylene, which are comparable in performance to liquid hydrogen are among them. For relatively weak sources methane is used as a solid block without fractionation. However, for high-power sources this method of using methane is not suitable because of the radicals accumulated in it and radiolytic hydrogen, which can break the cold moderator vessel. Therefore, methane can only be used as separate pellets, which are continuously exchanged in the moderator chamber. Now, such a technology with methane has not been implemented anywhere in the world and it needs to be developed. Developments in the preparation of methane pellets exist.

Mesitylene or its mixture with other aromatic hydrocarbons is a sufficiently effective material for use in cold moderators. It slows down neutrons well to low energies, is not explosive, does not accumulate radicals much, is resistant to decomposition under the influence of radiation, and it can be used in a wide temperature range. Over the past seven years, the IBR-2 at the JINR FLNP has gained extensive experience in the use of mesitylene as a cold moderator material. The individual beads of 3.5-3.8 mm are loaded into the moderator chamber with a flow of cold gaseous helium and remain there for the entire reactor cycle ~ 10 days with continuous cooling of cold gaseous helium. After completion of the cycle, the cooling stops, mesitylene is melted and removed from the moderator chamber. For a more powerful source, it is possible to organize a continuous / periodic change of material in the moderator chamber without stopping experiments on extracted beams. This technology requires additional study that will be carried out within this project.

In both cases of solid methane and mesitylene, the use of a grooved moderator in coupled geometry instead of a plane moderator increases the yield of cold neutrons by a factor of 2.

A new low dimensional cold moderators with 3 times increased brilliance of the emitted neutron beams have been developed within last few years. Such high brilliance source allowing tripling the intensity at the neutron instruments that operates with highly collimated neutron beams (SANS diffractometers and reflectometers). Such a moderator was manufactured at the Research Centre Jülich and is ready for the installation at the ESS.

#### ***3.2.4. Moderators for very cold neutrons***

The use of cold neutrons (wavelengths from 4Å to 20Å) in neutron scattering research allows for studies of the nanostructured objects offered by medicine and biology and becomes the current

trend worldwide. At the same time, using very cold neutrons (VCN) with wavelengths from 20Å to 100Å one can approach new levels of measurement accuracy in a number of techniques, e.g. neutron spin-echo and reflectometry. Moreover, VCN are also a very promising tool for research in the field of particle physics and studies of fundamental interactions (e.g. measurements the neutron lifetime, search for neutron-antineutron oscillations, etc.).

Unfortunately, VCN are currently not really used because of a low flux density of these neutrons at the extracted beams. However, a pulsed neutron source producing relatively long neutron pulse at low repetition rate (like the IBR-2) will fundamentally change the situation and allow for the production of VCN with maximum efficiency. This is because, on the one hand, the moderation of neutrons to low energies and their escape from the moderator volume takes a considerable time (about hundreds of microseconds); on the other hand, the transportation of VCN at a distance of about 10 m from the source into an experimental zone takes about 100 milliseconds. Indeed, to keep the advantage of the TOF technique allowing using the pulsed density of neutrons without losses of intensity the source repetition rate should not be more than 10 Hz to avoid the pulse overlapping.

Research with VCNs at the new neutron source will require designing the dedicated moderator and neutron beam optics. It must take into account the specific of VCN: relatively long moderation times and escape times from the moderator volume, large losses in matter. Appropriate developments will be based on the latest advances in the moderators for cold neutrons and neutron optics to obtain the maximum flux of VCN at the sample position under the best background conditions. All these new technologies - effective VCN production, optical systems for the VCN extraction, advanced methods for VCN applications - will be carried out at the IBR-2.

### ***3.2.5. Source of ultracold neutrons***

Ultracold neutrons (UCN) are the well-established experimental tool for research in the field of particle physics and fundamental interactions. Further increase in the intensity of UCN sources will allow both improving the accuracy of such experiments and significantly expanding the scope of the UCN's usage, for example, for studies of surfaces and thin films.

However, at present there are no UCN sources that use the pulsed time structure of the neutron source. The productivity of all modern UCN sources is determined by the average flux density.

Indeed, the UCN source at DNS-4 with mean power of 10 MW will be at the level of the best UCN sources in the world.

Meanwhile, it is already shown theoretically that the UCN density can be significantly increased and approach one corresponding to the peak power rather than the mean power of a pulsed neutron source. The accumulation of high intensity UCN pulses can be realized by the fast and tight UCN valve and the UCN time-focusing system at the end of a neutron guide. Relatively rare neutron pulses of DNS-4 significantly simplify technical requirements to these devices and make them feasible. Such UCN source that will provide the unprecedented density of UCN will be developed within the scope of the present project.

The moderator option that will simultaneously produce VCN and UCN will also be considered.

### **3.3. Neutron delivery systems**

The delivery of neutrons from moderators to neutron instruments will be achieved by a system of neutron guides. The most efficient neutron guides geometries - elliptic, parabolic and ballistic - will be used to minimize the losses and to tailor the phase space of the neutron beams according to individual requests of instruments. Such neutron guides will delivery to the samples only “useful” neutrons, thus maximizing the intensity at the samples, when minimizing the background of undesirable neutrons. For this purpose, each instrument will be equipped with its own dedicated neutron guide. Some of neutron instruments will profit a lot from the access both to thermal and cold neutrons. This will be accomplished by a specific design of in-pile parts of neutron guides that will “see” both cold and thermal moderators thus allowing for the bi-spectral beam extraction.

### **3.4. Instruments**

#### ***3.4.1. IBR-2 instruments continuous upgrade and development***

In a period 2020 – 2037 the IBR-2 instruments will be continuously upgrade and developed, providing new ideas for the DNS-IV instrumentation – moderators, neutron delivery system and instruments itself. What is important that the IBR-2 pulse duration is very close to the planned DNS-IV one, so many solutions for neutron guides, choppers etc. could be transferred directly to the DNS-IV.

### ***3.4.2. DNS-IV instruments development***

We will perform a smart design of neutron instruments that will benefit from the time structure of the pulsed neutron source and allow for simultaneous measurements over a wide energy and angular ranges of scattered beams. The performance of each instrument will be thoroughly simulated by established simulation packages (McStas and VITESS) in the iterative procedure aiming at the optimization of instrument geometries and design for achieving the world-class performance. This should result in the final adjustment of the requirements to the time structure of the neutron beams.

It is important to note, that the construction work at the new source will be carried out without phasing out the IBR-2, so that the commissioning of the new source should take place during the final operation years of IBR-2. This will allow new technical and instrumental decisions to be tested at neutron beams of IBR-2.

## **4. PROJECT STATUS AND ROADMAP, RISK ASSESSMENT**

### **4.1. DNS-IV roadmap**

This Section provides conclusions for the presented short description of the DNS-IV conceptual research. It was carried out in the Frank Laboratory of Neutron Physics of JINR in cooperation with the Dollezhal Research and Development Institute of Power Engineering (NIKIET), which has performed the engineering design of the most research reactors in Russia including JINR reactors and in other countries, including some JINR member states.

Next steps for the realization of DNS-IV are as follows:

- technical study;
- R&D phases;
- engineering design;
- construction phase;
- start of facility operation;

The following timetable is suggested (Figure 12).

The technical study has identified several areas at the frontiers of existing technology where R&D is needed. High-priority areas involve the development of a target station, neptunium nitride

fuel elements, thermal stress and radiation effects in target materials, moderators, accelerators, neutron instruments.

The goals of the R&D phase are to provide the database for the engineering design and prepare the technical and economic basis for a final conclusion about the construction of the DNS-IV which would minimize costs and technical risks.

The main expected results of the R&D phase will be:

- resolution of key technical issues which have been identified;
- validated database for the engineering design;
- accurate cost estimate;
- determination of site requirements and safety aspects, including licensing issues;
- timetable and budget profile for construction.
- 

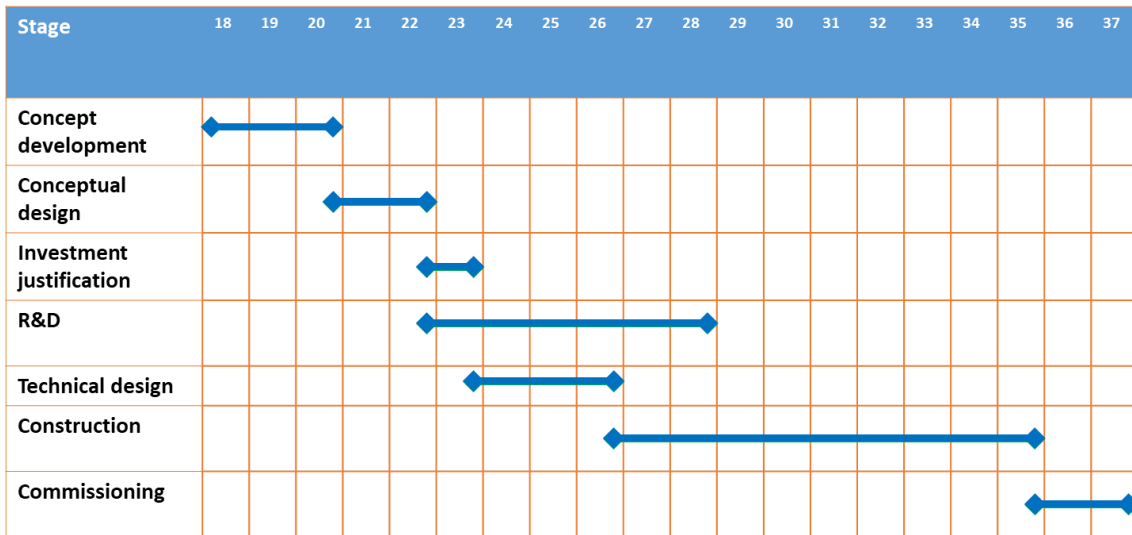

Figure 12: DNS-IV roadmap (preliminary)

#### 4.2. Placement and costs

It is an important point to make a site-independent (green field) cost estimate for construction and operation of the DNS-IV. The preferable place for the new neutron source would be nearby the IBR-2 reactor as it will make it possible to use the existing engineering infrastructure and reduce the total cost by decreasing significantly the cost for site preparation. We should add to the total cost the above-mentioned staff costs for construction and development phases. It will account for some 20%



of this total. Project costs will be finally and more precisely estimated at the preliminary design stage by the end of 2022 (see roadmap, Figure 12). Here, very rough estimates are presented.

Looking back in history is often an entertaining insight in the evaluation of resources needed for similar projects. Taking the IBR-2 cost as the reference point and making time corrections we could estimate the IBR-3 construction cost, if we would know all the relevant inflation indices for similar constructions.. The very first real cost estimation of the IBR-2 construction was presented at the report of the USSR state design institute from 1967. It amounts to 12,7 MRoubles. Later on (1968) this value was corrected to 16.7 MRoubles; the final correction made in 1975 finalised the IBR-2 construction cost at 20.8 MRoubles (**Fehler! Verweisquelle konnte nicht gefunden werden.**), that corresponds to 38.3 M\$ (official exchange rate 54.36 USSR roubles for 100 US dollars). Projected to the December 2018, a price of 185.4 M\$ could be deduced. Today Of course, the structure of the reactor project cost at USSR and modern Russian Federation is quite different.

The cost evolution of the PIK reactor at Gatchina cannot serve as a calibration since it has too long a history of construction under different economical situations.

For another estimation a reactor project in Germany may be looked at, which is closer in time to the present: Construction of the FRM-II reactor at Garching. The total costs of FRM II built in 1997-2000: 680 million German Marks or 340 MEUR. Taking into account the average inflation rate of 2% for 20 years, it will amount to 510 MEUR in Euros of 2020. However, inflation indices for nuclear technical equipment is hard to come by. From experience at the NICA project, today technical construction projects in Russia cannot benefit any longer from the still significant difference in labor costs in Russia and Germany or elsewhere in the World. Cost lowering measures could be obtained by using a certain part of the infrastructure of IBR-2, e.g. power lines and transformers, a part of neutron instruments, etc. About 20% of the estimated sum of construction costs is added as contingency. Rough estimates of the DNS-IV construction cost is given below (Table 5) based on 2019 prices.

**Table 5: projected DNS-IV construction cost estimates**

Component	Cost, M€
Reactor	150
Moderators complex	50
Neutron beams instrumentation	100

R&D	20
Engineering infrastructure	50
<b>Sub-total</b>	<b>370</b>
Contingency 20%	75
<b>Total:</b>	<b>445</b>

The annual operating costs are estimated on the basis of exploitation experience of the IBR-2 reactor. The estimate amounts to 4-5 M€ including 150 staff and power consumption costs (IBR-2 operational cost for 2018, including salary, amounts to 2.5 M\$).

### 4.3. Status of the project

- At the 42<sup>nd</sup> meeting of the PAC for Condensed Matter Physics of JINR on June 22, 2015 in the report on the FLNP proposals to the JINR seven-year development plan for 2017-2023, the issue of creating a new source was raised for the first time.
- At the 45<sup>th</sup> meeting of the PAC for Condensed Matter Physics of JINR on January 19, 2017 two design concepts of a new source drawn up in the Laboratory were presented and an overview of the situation with neutron sources in Europe for the coming decades was given. By now, at several meetings of the PAC for Condensed Matter Physics, the FLNP scientists have presented the technical details of the two proposed concepts and provided a preliminary rationale for the scientific program for the new neutron source.
- In the framework of the preparation of the JINR Strategic Development Programme until 2030, an international Working Group of the Commission for JINR Strategic Long-Range Planning (co-chaired by Profs. V.Aksenov (JINR) and A.Ioffe (Juelich Centre for Neutron Science, Forschungszentrum Juelich, Germany) was established to coordinate and elaborate the scientific and technical justification of the project on the construction of the fourth-generation Dubna neutron source. Three meetings of this Working Group were held in 2018 and 2019.
- In December 2018, the International Workshop “Advanced ideas & experiments for DNS-IV” was convened.

- In June 2019, the PAC for Condensed Matter Physics has strongly supported the opening of a new theme “Development of the Conceptual Design of a New Advanced Neutron Source at JINR” with the following deliverables for next 3 years:

	<i>Work description</i>	<i>Date</i>	<i>Result/deliverable</i>	<i>Costs, k\$</i>
1.	Analysis of scientific rationale for a new source.	07/2019 - 01/2020	First draft of the White Book	10
2.	Preparation of the White Book.	06/2020	Final version of the White Book	20
3.	Feasibility studies for two types of periodic high-flux neutron sources: pulsed reactor (PR) and accelerator-driven (ADNS) (NIKIET & LNF JINR)	07/2019 - 06/2020	Technical reports	800
4.	Preparatory work for the development of the production technology for fuel/target for the new source;	06/2020 - 12/2021	Report	800
5.	The concept of the arrangement of neutron moderators and neutron beams’ extraction.	07/2019 - 06/2022	Final concept for neutron moderators and in-pile neutron guides	100
6.	Simulation of the performance of neutron scattering instruments at a new source	10/2019 - 12/2021	Reports	150
7.	Preparation of technical specification for neutron instruments and in-pile parts of neutron guides required for the technical design of the source.	12/2021- 06/2022	Technical specifications	90
8.	Prototyping of the fuel elements	01/2021- 12/2022	Experimental report	500
9.	Simulation and preparation of the preliminary safety report	01/2021- 12/2022	Draft of the safety report	200
			<b>Total:</b>	<b>2670</b>

The construction of DNS-IV will bring new opportunities and challenges for industries of JINR Member States, especially related to nuclear power industry sectors. We believe that the return for science and technology, which DNS-IV can deliver during 40 years of its expected service life will be more than enough to justify the commitment of funds.

#### **4.4. Risk assessment**

Though results of feasibility study carried out by NIKIET ensuring us that the desired neutron flux density can be achieved using Np-237 fuel for DNS-IV, there is a risk associated with the fuel production technology.

To minimize this risk, we have already established working relations with A.A. Bochvar All-Russian Scientific Research Institute for Inorganic Materials (VNIINM) that will prepare the roadmap on the NpN fuel fabrication (with technical and economical estimations) at the stage of conceptual design.

The back-up solution is the use of plutonium oxide fuel (as at the operating IBR-2 reactor). Interaction with other fields of Science and socially significant applications

The construction of the Dubna neutron source of the fourth generation (DNS-IV) which will have significantly higher parameters than at IBR-2 reactor will open absolutely new possibilities in the use of neutron scattering in other fields of science such as chemistry, molecular biology, material and engineering sciences.

Besides this great opportunities will be opened for such socially significant applications such as medico-biological investigations, pharmacology, neutron diagnostic of cultural heritage and archaeometry.

The construction of DNS-IV will bring new opportunities and challenges for industries of JINR Member States, especially related to nuclear power industry sectors. We believe that the return for science and technology, which DNS-IV can deliver during 40 years of its expected service life will be more than sufficient to justify the commitment of funds.

## **5. TRAINING OF YOUNG SCIENTISTS AND SPECIALISTS**

JINR has a well-developed and active Training centre for JINT member states which trains specialists in many areas of science.

On the base of Frank Laboratory of neutron physics the chair on neutron scattering of Lomonosov Moscow State University train young scientists and specialists during last decades.

## **6. INTERACTION WITH OTHER FIELDS OF SCIENCE AND SOCIALLY SIGNIFICANT APPLICATIONS**

The construction of the Dubna neutron source of the fourth generation (DNS-IV) will have significantly higher parameters than at IBR-2 reactor, even be competitive to the European Spallation Source ESS, and will open new possibilities in the use of neutron scattering in other fields of science such as chemistry, molecular biology, material and engineering sciences.

Great opportunities will be opened for such socially significant applications such as medicobiological investigations, pharmacology, neutron diagnostic of cultural heritage and archaeometry.

The construction of DNS-IV will bring new opportunities and challenges for industries of JINR Member States, especially related to nuclear power industry sectors. The return for science and technology, which DNS-IV can deliver during 40 years of its expected service life, will be more than sufficient to justify the commitment of funds.

## References:

---

<sup>1</sup> V.L.Aksenov, JINR Communications, E3-2017-12, Dubna, 2017

<sup>2</sup> Е.Яник. Нейтронные исследования кристаллической решетки и ее квазичастиц. Атомная энергия (1969), т. 27, вып. 6, с. 533-540

<sup>3</sup> В. Л. Аксенов. А.М.Балагуров. Дифракция нейтронов на импульсных источниках. Успехи физических наук (2016), т. 186, №3, с. 293-320

<sup>4</sup> Aksenov V.L. Neutron physics Entering to XXI Century. Particle and Nucl. Phys. (Физика ЭЧАЯ), V.31, N 6, P. 1304 – 1342 (2000)

<sup>5</sup> Aksenov V L, Balagurov A M "Neutron diffraction on pulsed sources" Phys. Usp. 59 279–303 (2016)

<sup>6</sup> ESFRI Scripta Volume I Neutron scattering facilities in Europe Present status and future perspectives ESFRI Physical Sciences and Engineering Strategy Working Group Neutron Landscape Group, ISBN: 978-88-901562-5-0

<sup>7</sup> Superbooster NEPTUN Dubna Neutron Source of the Fourth Generation. <http://flnph.jinr.ru/images/content/Books/Blok.pdf>

<sup>8</sup> Aksenov V.L., Ananiev V.D., Komyshev G.G., Rogov A.D. and Shabalin E.P. Phys.Particles and Nuclei Lett.,v.14, N 5, 2017

<sup>9</sup> Shabalin, E.P., Aksenov, V.L., Komyshev, G.G. et al. Neptunium-Based High-Flux Pulsed Research Reactor. At Energy (2018) 124: 364. <https://doi.org/10.1007/s10512-018-0424-3>