

# BM@N carbon beam pipe

M. Janda<sup>1</sup>, F. Lopot<sup>1</sup>, M. Rachac<sup>1</sup>  
**P. Chudoba<sup>2</sup>**, A. Kugler<sup>2</sup>, V. Kushpil<sup>2</sup>

<sup>1</sup>Faculty of Mechanical Engineering of the Czech Technical University

<sup>2</sup>Nuclear physics institute, The Czech Academy of Sciences

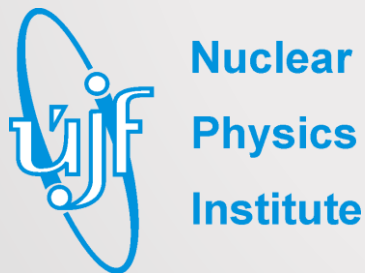

*chudoba@ujf.cas.cz*

October 21, 2020



# Updated BP design

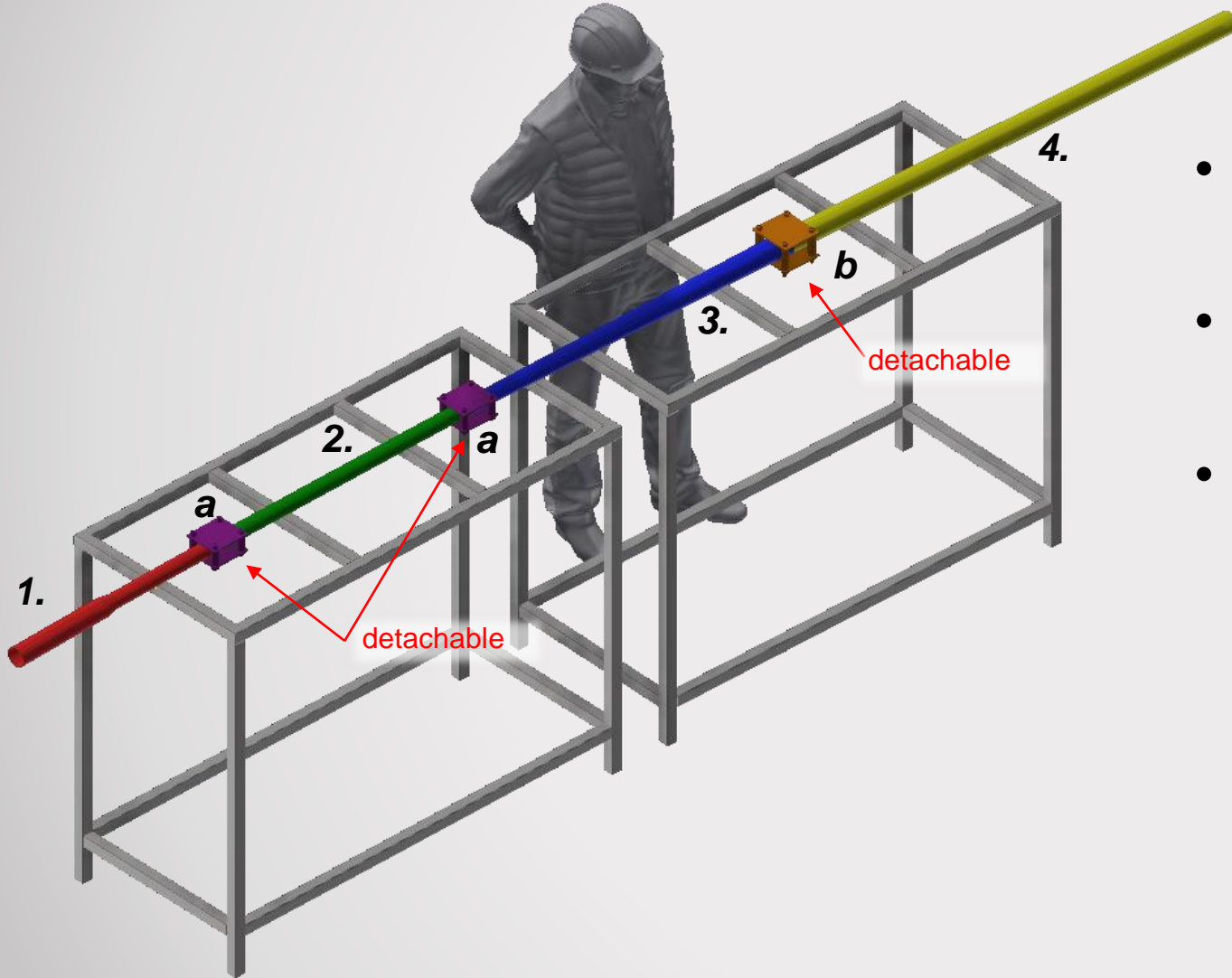

- All of the pipes (**1.-4.**) are detachable
- Ends of the pipes are redesigned as required
- Mounting tools (**a,b**) for easier assembling are added

# Updated BP design

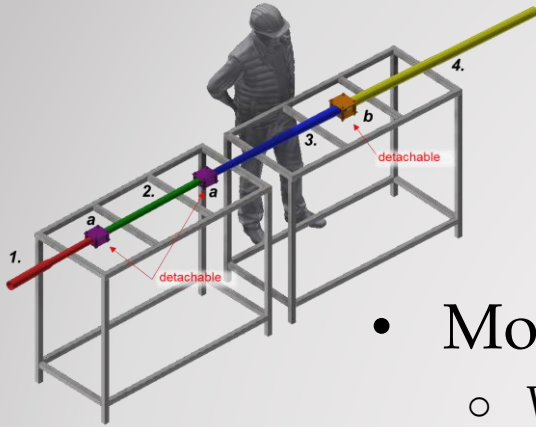

- Mounting tools for easier assembling were added
  - Wall thicknesses are as low as possible (2.8 mm and 3.15 mm)
  - The length of these walls is not more than 100 mm

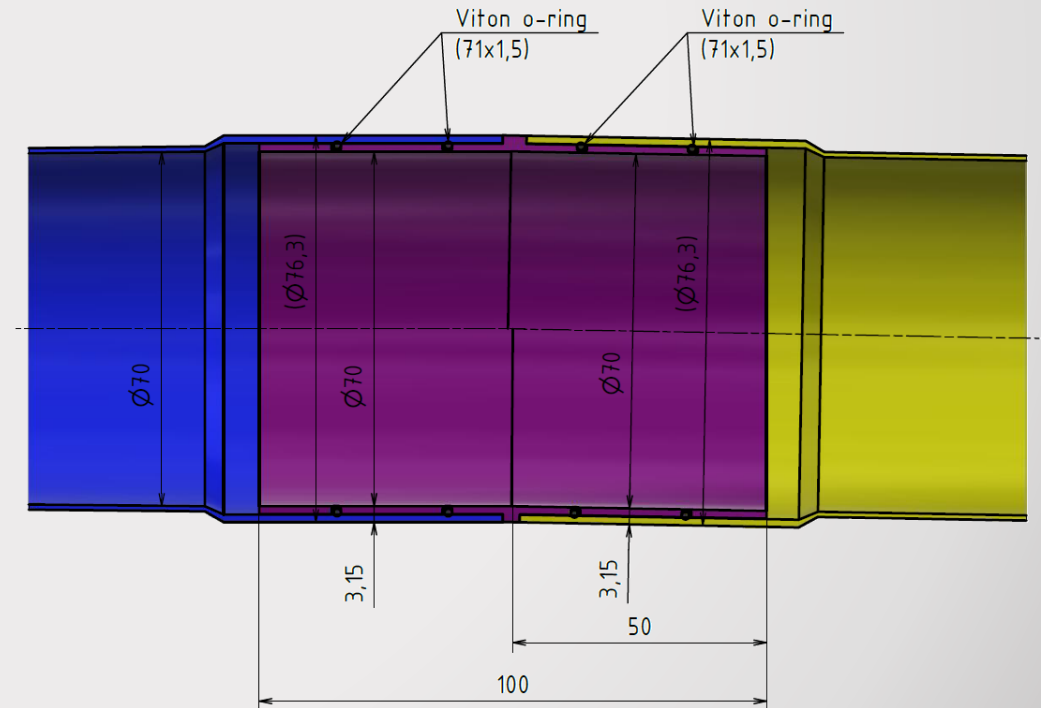
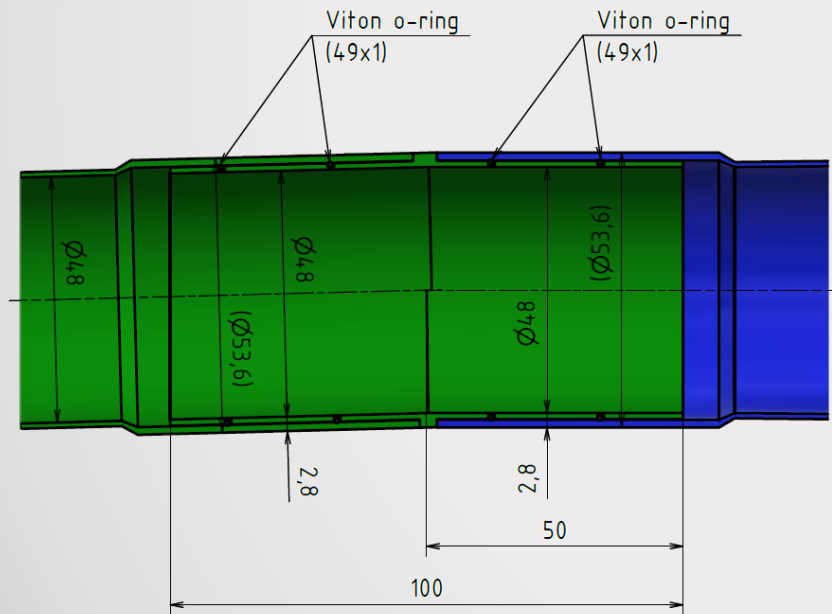

# Updated BP design

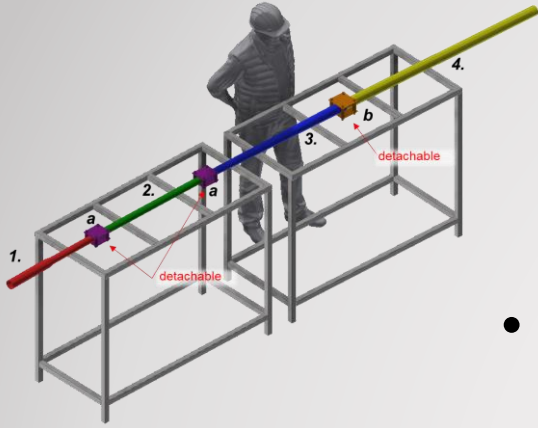

- Ends of the pipes are redesigned as required
  - To find the exact pipes position a special pipe end shapes are developed
  - Mounting tools are developed for precise and simple installation

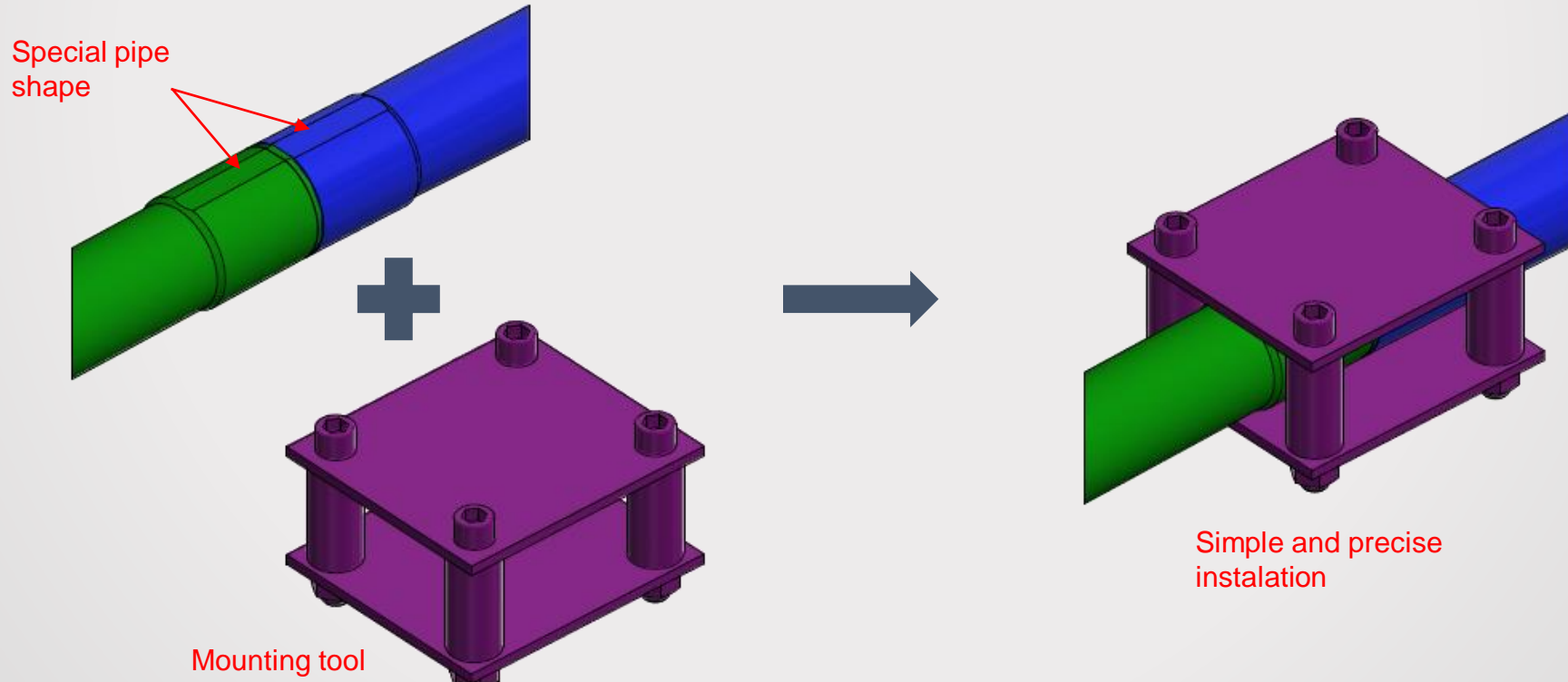

# Updated BP design

- From my point of view, this is the final design version
- If you have any comments or questions, do not hesitate to contact [marek.rachac@gmail.com](mailto:marek.rachac@gmail.com)

