

# Probing the *Deuteron* short-range *Spin Structure* in the (d,p) reactions using polarized deuteron beam at Nuclotron

## *DSS* - project

V.A.Baskov<sup>2</sup>, E.V.Chernykh<sup>1</sup>, I.Dobrin<sup>3</sup>, V.A.Dronov<sup>2</sup>, D.Enache<sup>3</sup>, S.G.Genchev<sup>4</sup>, Yu.V.Gurchin<sup>1</sup>, A.Yu.Isupov<sup>1</sup>, F.Černobila<sup>5</sup>, M.Janek<sup>5</sup>, J.-T.Karachuk<sup>3</sup>, A.N.Khrenov<sup>1</sup>, V.P.Ladygin<sup>1†</sup>, N.B.Ladygina<sup>1</sup>, A.N.Livanov<sup>1</sup>, A.I.Lvov<sup>2</sup>, Y.Maeda<sup>6</sup>, G.Martinska<sup>7</sup>, O.Mezhenska<sup>7</sup>, K.Miki<sup>8</sup>, S.Nakai<sup>8</sup>, S.Ohta<sup>9</sup>, S.M.Piyadin<sup>1</sup>, V.V.Polansky<sup>2</sup>, S.G.Reznikov<sup>1</sup>, D.Sakai<sup>8</sup>, K.Sekiguchi<sup>8</sup>, S.Shibuya<sup>8</sup>, S.S.Sidorin<sup>2</sup>, V.V.Syschenko<sup>10</sup>, G.Tarjányiová<sup>5</sup>, A.A.Terekhin<sup>1</sup>, A.V.Tishevsky<sup>1</sup>, T.Uesaka<sup>11</sup>, J.Urban<sup>7</sup>, M.Veverichek<sup>5</sup>, A.Watanabe<sup>8</sup>, I.E.Vnukov<sup>10</sup>, I.S.Volkov<sup>1</sup>.

(1) *Joint Institute for Nuclear Research, Dubna, Russia*

(2) *Lebedev Physical Institute of the Russian Academy of Sciences, Moscow, Russia*

(3) *Advanced Research Institute for Electrical Engineering, Bucharest, Romania*

(4) *Laboratory for Technical Developments and Applications of the BAS, Sofia, Bulgaria*

(5) *Physics Department, University of Žilina, Žilina, Slovak Republic*

(6) *Department of Applied Physics, University of Miyazaki, Miyazaki, Japan*

(7) *P.J.Šafarik University, Košice, Slovak Republic*

(8) *Department of Physics, Tohoku University, Sendai, Japan*

(9) *Center for Nuclear Study, University of Tokyo, Tokyo, Japan*

(10) *Belgorod State National Research University, Belgorod, Russia*

(11) *RIKEN Nishina Center, Saitama, Japan*

† *Contact person: vladygin@jinr.ru*

Project Leaders: M.Janek<sup>5</sup>, V.P.Ladygin<sup>1</sup>, K.Sekiguchi<sup>9</sup>

## Abstract

The main goal of the project is to study the deuteron and three-nucleon systems short-range spin structure via the measurements of the polarization observables in the  $dp$ -,  $pd$ - and  $dd$ - reactions at Nuclotron.

The beam energy scan of the analyzing powers  $A_y$ ,  $A_{yy}$  and  $A_{xx}$  in  $dp$ - elastic scattering between 400 MeV and 1800 MeV has been performed.

In the next term DSS collaboration is planning to measure the deuteron analyzing powers  $A_y$ ,  $A_{yy}$  and  $A_{xx}$  in  $dp$ - non-mesonic breakup for different kinematic conditions at 300-500 MeV. The energy scan of the deuteron  $A_y$ ,  $A_{yy}$  and  $A_{xx}$  analyzing powers in  $dp$ - elastic scattering in the deuteron energy range of 300-700 MeV with the step of 50 MeV is also planned. The availability of the polarized proton beam allows to perform the measurements of the nucleon analyzing power  $A_y^p$  in  $pd$ - non-mesonic breakup for different kinematic conditions at 150-250 MeV/nucleon, as well as the energy scan of the proton analyzing power  $A_y^p$  in  $pd$ - elastic scattering at 150-1000 MeV/nucleon at Internal Target Station.

The feasibility study of  $dd$ - collisions at the intermediate energies at Internal Target Station are planned since these investigations can provide the important information of the structure of the three- and four- nucleons forces.

In the framework of the project the deuteron beam polarimetry will be developed at Internal Target Station and at the extracted deuteron beam at Nuclotron. R&D works on the deuteron and proton polarimeters for NICA and other polarization techniques are planned.

# 1 Introduction

The main goal of the *DSS* experiment is to study the spin structure of two-nucleon (2N) and three-nucleon (3N) short-range correlations via the measurements of the polarization observables in the deuteron induced reactions (*pd*-, *dp*- and *dd*- interactions) at Nuclotron.

Short range correlations (SRC) of nucleons in nuclei is the subject of intensive theoretical and experimental works during last years. Since SRC have densities comparable to the density in the center of a nucleon which is about  $\rho \sim 5\rho_0$  ( $\rho_0 \approx 0.17 \text{ fm}^{-3}$ ), they can be considered as the drops of **cold dense nuclear matter** [1]. These studies explore a new part of the phase diagram and very essential to understand the evolution of neutron stars.

The results obtained at BNL [2], SLAC [3] and JLAB [4, 5] clearly demonstrate that: (i) more than 90% all nucleons with momenta  $k \geq 300 \text{ MeV}/c$  belong to 2N SRC; (ii) probability for a given proton with momenta  $300 \leq k \leq 600 \text{ MeV}/c$  to belong to *pn* correlation is  $\sim 18$  times larger than for *pp* correlations; (iii) probability for a nucleon to have momentum  $\geq 300 \text{ MeV}/c$  in medium nuclei is  $\sim 25\%$ ; (iv) 3N SRC are present in nuclei with a significant probability [6]. However, still many open questions persist and further investigations are required both from the experimental and theoretical sides. For instance, the experimental data on the spin structure of 2N ( $I=1$ ) and 3N SRC are almost absent.

The main tools to study SRCs at hadronic facilities can be deuteron structure investigations at large internal momenta allowing to explore 2N SRC with  $I = 0$ ;  $^3\text{He}$  structure to understand the role of 2N SRC with  $I = 1$  and 3N SRC; nuclei breakup  $A(p, pp)X$ ,  $A(p, pn)X$ ,  $A(p, ppp)X$  etc. with the detection of few nucleons in the final state. The greatest importance is the study of the spin effects in these reactions because the data on the SRCs spin structure are scarce. Nuclotron and NICA will allow to investigate the spin effects for multi-nucleon correlations in a wide energy range.

The model of 2N and 3N correlations at low and moderate energies (below pion threshold production) can be built from the boson-nucleon picture of strong interaction. During last several years a new generation of nucleon-nucleon potentials are built (Nijmegen, CD-Bonn, AV-18 etc.). These potentials reproduced the NN scattering data up to 350 MeV with very good accuracy. But these potentials cannot reproduce triton binding energy (underbinding is 0.8 MeV for CD-Bonn), deuteron-proton elastic scattering and breakup data. Incorporation of three nucleon forces (3NF), when the interaction depends on the quantum numbers of the all three nucleons, allows to reproduce triton binding energy and unpolarized deuteron-proton elastic scattering and breakup data (see [7] and references

therein). The contribution of 3NF is found to be up to 30% in the vicinity of Sagara discrepancy for deuteron-proton elastic scattering at intermediate energies [8, 9]. However, the use of different 3NF models in Faddeev calculations can not reproduce polarization data intensively accumulated during last decade at different facilities [8]–[14].

On the other hand,  $pd$ - elastic scattering cross section data obtained already at 250 MeV [11] can not be reproduced by the Faddeev calculations with the inclusion of modern 3NF. The authors stated that the reason of this discrepancy can be neglecting by new type of short-range 3NF. At higher energies, Faddeev calculations fail to reproduce the cross section at the angles larger than  $90^\circ$ . The relativistic multiple scattering calculations [15, 16] give much better agreement with the data at the angles between  $60^\circ$  and  $130^\circ$ . It is shown that the double scattering dominates over the single scattering starting from  $\sim 70^\circ$ . The deviation of the data on the calculations at backward angles are related with the manifestation of  $s$ - type of Fujita-Miyazawa 3NF. Some discrepancy exists around  $90^\circ$ , which can be connected with new type of SR 3NF. These forces can be built within approaches beyond one-boson-exchange. For instance, in the dressed bag model [17] 3NF comes from the interaction between intermediate six-quark state dressed by  $\sigma$ -field and the third nucleon. The description of 2N and 3N correlations at the energies higher than several hundreds MeV/nucleon should be obtained within QCD [1].

Nuclotron provided no beam due to NICA construction in 2019-2021. Therefore, the scientific program of the *DSS* project for 2019-2021 focused on the following directions.

- Data analysis of the results on the systematic measurements of the cross section,  $A_y$ ,  $A_{yy}$  and  $A_{xx}$  analyzing powers in  $dp$ - elastic scattering at the energies 270-2000 MeV [18, 19] at Internal Target Station (ITS) [20] at Nuclotron.
- Data analysis of the cross section in  $dp$ - non-mesonic breakup at the energies below 500 MeV for different kinematic configurations of two final protons (complanar and space-star).
- Data analysis on the deuteron and proton beam polarization measurements at ITS for the polarized deuteron and proton beams with the intensity up to  $5 \cdot 10^8$  and  $2.5 \cdot 10^7$  ppp, respectively.
- The simulation and upgrade of the DSS-setup in order to use it as a wide energy range proton polarimeter and for the measurements of the nucleon analyzing power in  $pd$  - elastic scattering. R&D for new polarimeter techniques.
- The continuation of the theoretical analysis of the observables in hadronic reactions with the participation of light nuclei.

The cross section measurements has been performed using unpolarized beam at Nuclotron. The polarization measurements at ITS has been performed using rather low intensity of polarized deuteron beam. Actually, these measurements were be performed during the commissioning run with new PIS [22]. The priority was given to the measurements of the angular dependence of  $A_y$ ,  $A_{yy}$  and  $A_{xx}$  analyzing powers in  $dp$ - elastic scattering at the energies between 700 and 2000 MeV.

The experiment has been approved in June 2009, prolonged in June 2011 for the period 2013-2015, in June 2014 for the period 2016-2018 and in June 2018 for the period 2019-2021 with the first priority.

## 2 Experiment DSS at Internal Target Station

At intermediate energies, intensive studies on three-nucleon force effects are proceeded via the deuteron-proton and deuteron-neutron elastic scattering and breakup reactions. At energies  $T_d \leq 300$  MeV, Faddeev calculations can provide good description of cross section data, by introducing a three nucleon force, over the whole angular range. However, their reproduction of polarization observables are not as good as that for cross section data, which may be regarded as an insufficiency of our knowledge on spin-dependence of three nucleon force. To clarify the situation of the spin-dependence, it is undoubtedly promising to perform systematic study of polarization observables in the region of so called "cross section minimum" which spans  $\theta_{\text{cm}} = 90^\circ\text{--}130^\circ$ . At higher energies, for example  $T_d = 500$  MeV, the Faddeev calculation deviates from the cross section data at backward angles. This may be due to relativistic effects and/or new three-nucleon force other than Fujita-Miyazawa type. Subthreshold pion production may play a role. At higher energies 2N and 3N SRC can manifest. Measurement of energy dependences of polarization observables in the region of cross section minimum can give an irreplaceable clue to the problem.

The ITS setup is well suited for study of energy dependence of polarization observables for the deuteron-proton elastic scattering and deuteron breakup reaction with the detection of two protons at large angles (see Fig.1).

The measurements of the cross section, deuteron analyzing powers  $A_y$ ,  $A_{yy}$  and  $A_{xx}$  in  $dp$ - elastic scattering at  $T_d = 300\text{--}2000$  MeV in the vicinity of cross section minimum using Internal Target Station (ITS) at Nuclotron has been proposed [19]. Earlier the measurements of the cross section and analyzing powers for the both  $dp$ - elastic scattering and  $dp$ - breakup reaction have been proposed at  $T_d = 300\text{--}500$  MeV [18].

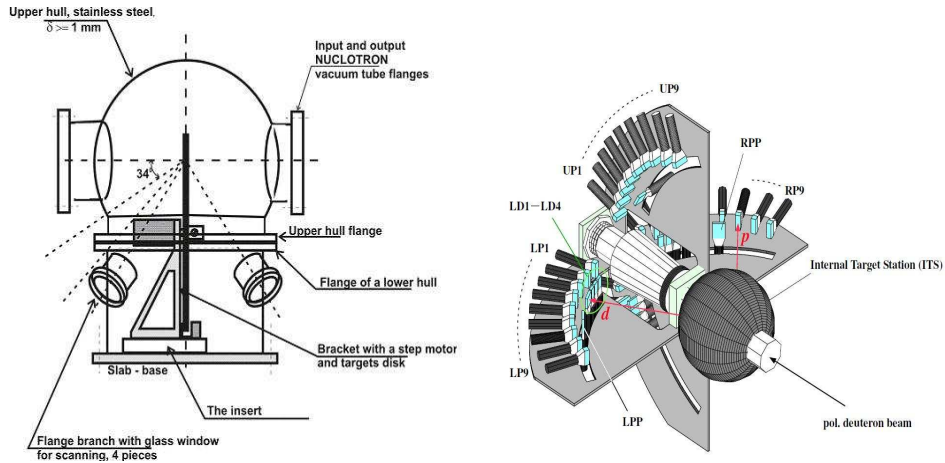

Figure 1: Schematic view of the ITS [20] and detection system for  $dp$ -elastic scattering studies.

### 3 New experimental results obtained at ITS in 2019-2021

The target  $CH_2$  of 10 mkm thick is used for the measurements at ITS. The yield from carbon content of the  $CH_2$  target is estimated in separate measurements using carbon wire. The monitoring of the intensity is done from the detection of  $pp$ -quasielastic scattering at  $90^\circ$  in cms by the scintillation counters placed in the horizontal plane. The detection of the  $dp$ -elastic events is done by the coincidence measurements of the proton and deuteron. The detectors are placed in the horizontal plane only for the cross section measurements and in the both horizontal and vertical planes for the analyzing powers measurements. The selection of the  $dp$ -elastic events is done by the correlation of the energy losses in plastic scintillators for deuteron and proton and their time-of-flight difference. The interaction point for each event is reconstructed by the target position monitor [23] and used in the data analysis.

#### 3.1 Cross section $dp$ -elastic scattering at 1000-1800 MeV

The procedure of the  $CH_2 - C$  subtraction for scattering angle  $\theta_{cm} = 75^\circ$  at 500 MeV/n is shown in Fig. 2. The  $CH_2$  distribution and the normalized  $C$  spectrum are shown in the left panel by the solid- and dashed-line histograms, respectively. The results of the  $CH_2 - C$  subtraction is given in the right panel of Fig. 2.

The measurements of the cross section have been performed at as a first stage of these studies Nuclotron between 500 and 1000 MeV/nucleon [24, 25, 26]. The results on the angular behaviour of the  $dp$ -elastic scattering cross section at 500 MeV/nucleon,

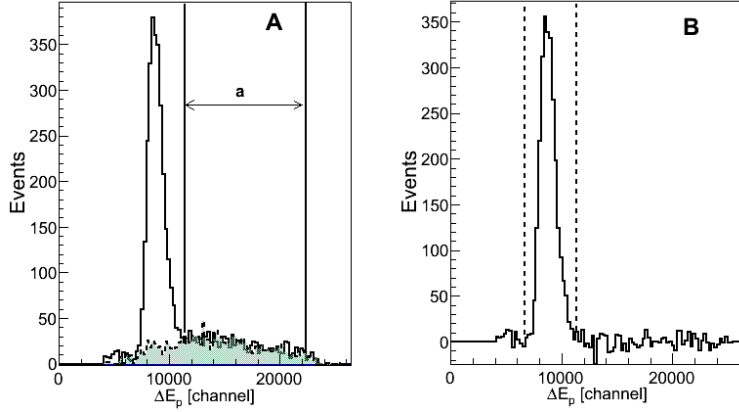

Figure 2: Procedure of  $CH_2 - C$  subtraction for  $\theta_{cm} = 75^\circ$  at the energy of 500 MeV/n. A - is the  $CH_2$ - and normalized  $C$ - distributions given by the solid and dashed histograms, respectively, vertical solid lines - is the interval of the normalization. B - is the result of  $CH_2 - C$  subtraction, vertical dashed lines are the gates indicating the domain of the  $dp$ -elastic scattering events.

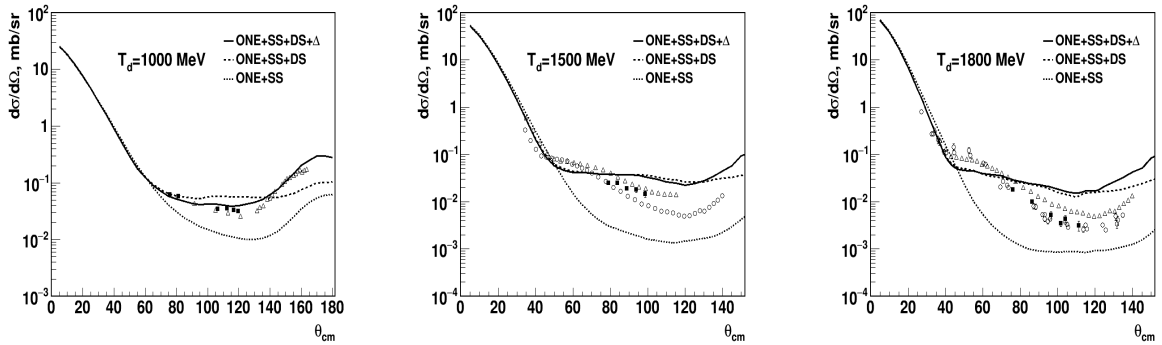

Figure 3: The results on the angular behaviour of the  $dp$ - elastic scattering cross section at 500 MeV/nucleon, 750 MeV/nucleon and 900 MeV/nucleon shown in the left, middle and right panels, respectively. The solid and open symbols are the data obtained at Nuclotron and the world data. The dashed and solid lines are the calculations performed in the framework of the relativistic multiple scattering model without and with the  $\Delta$ -isobar excitation [27].

750 MeV/nucleon and 900 MeV/nucleon [26] shown in the left, middle and right panels of Fig.3, respectively. The data obtained at Nuclotron shown by the solid symbols are compared with the world data shown by the open symbols. The theoretical calculations were performed in the relativistic multiple scattering expansion formalism [15, 16, 27]. The four contributions are taken into account: one-nucleon-exchange, single- and double-scattering, and  $\Delta$ - isobar excitation. The presented approach was applied earlier to describe the differential cross sections at deuteron energies between 500 and 1300 MeV in a whole angular range [27]. The dashed line in Fig. 3 is the result of the calculations taking into account one-nucleon exchange (ONE) and single-scattering (SS) diagrams only, while the dotted line is obtained when double-scattering (DS) term is added into the consideration [15, 16]. The full calculation with  $\Delta$ - isobar excitation included is given by the solid line [27]. One can see that the differential cross section is described quite well up to the scattering angles of  $\sim 60^\circ$  taking into account only the ONE and SS terms. If we consider the  $dp$ -elastic scattering at the angles larger than  $60^\circ$ , it is necessary to include the DS term into consideration. It should be noted the double-scattering contribution into the reaction amplitude increases with the deuteron energy growing and may change the value of the differential cross section on a few orders in comparison with the result obtained without inclusion of the DS-term. The  $\Delta$ - excitation begins to manifest itself at the angle equal to about  $120^\circ$  and describes the behaviour of the experimental data at the angle above  $140^\circ$  where the differential cross section sharply increases. It has been demonstrated also that the contribution of the  $\Delta$ - isobar mechanism grows with the initial deuteron energy. It is negligible at  $T_d = 500$  MeV and very significant at higher energies [27]. Taking into account the  $\Delta$ -isobar excitation improves the agreement with the experimental data. However, the deviations are still large. The deviation of the data from the calculations at large angles can be related with the contribution of more complicated reaction mechanisms like three- nucleon SRCs or excitation of heavy baryonic resonances.

At high energies and large transverse momenta the constituent counting rules (CCR) [28] predict a  $1/s^{n-2}$  dependence of the differential cross section for the binary reaction, where  $n$  is the total number of the fundamental constituents involved in the reaction. The differential cross sections at high energy and large transverse momenta for the exclusive processes can be written as:

$$\left(\frac{d\sigma}{dt}\right)_{AB \rightarrow CD} \sim s^{2-n} \cdot f(\cos \theta^*) \quad (1)$$

where  $n$  is the total number of the fundamental degrees of freedom (quarks, leptons and photons) involved both in the initial and the final states of the  $AB \rightarrow CD$  process,  $\theta^*$  is the center of mass angle,  $s$  and  $t$  are the Mandelstam variables. For instance,  $n$  is equal to 18 for  $dp$ - elastic scattering .



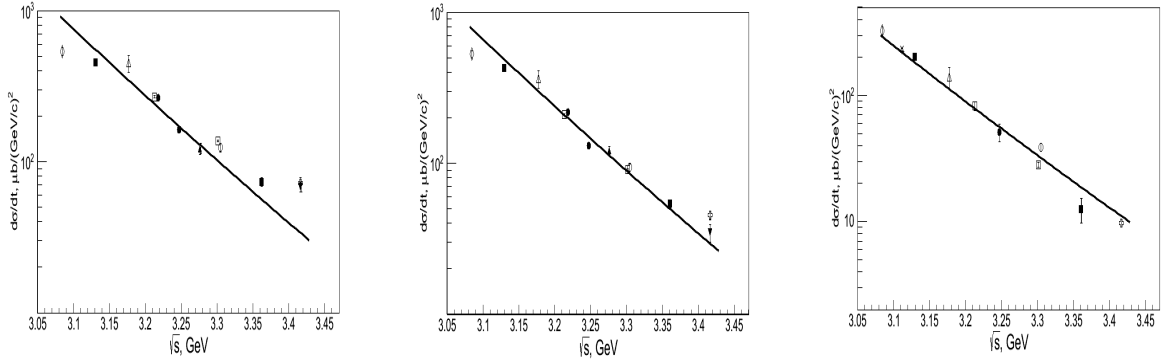

Figure 4: Differential cross section of  $dp$ -elastic scattering at the fixed scattering angle  $\theta_{cm} \sim 75^\circ, \sim 82^\circ, \sim 111^\circ$  [26] as a function of the  $\sqrt{s}$  is shown in the left, middle and right panels, respectively. Full symbols are the data obtained at the Nuclotron, open symbols are the world data. Lines are the result of the world data approximated by the function  $\sim s^{-16}$ .

Differential cross section of  $dp$ -elastic scattering at the fixed scattering angles in the cms  $\theta_{cm} \sim 75^\circ, \sim 82^\circ, \sim 111^\circ$  as a function of the  $\sqrt{s}$  is shown in the left, middle and right panels of Fig.4. Full symbols are the data obtained at the Nuclotron, open symbols are the world data. Lines are the result of the world data approximated by the function  $\sim s^{-16}$  coming from the constituent counting rules (CCR) [28]. The data at fixed scattering angles in the cms are in a qualitative agreement with the behavior of the world data. The discrepancy between data and CCR is decreasing with the scattering angle increasing.

### 3.2 Analyzing powers in $dp$ - elastic scattering data

The upgraded setup at ITS has been used to measure the vector  $A_y$  and tensor  $A_{yy}$  and  $A_{xx}$  analyzing powers in  $dp$ - elastic scattering between 400 MeV and 1800 MeV using polarized deuteron beam from new source of polarized ions SPI [22]. These measurements were performed using internal target station at Nuclotron [20] with new control and data acquisition system [29]. The existing setup [21] has been upgraded by new VME based DAQ, new MPod based high voltage system, new system of monitors etc.

New SPI [22] has been used to provide polarized deuteron beam. In the current experiment the spin modes with the maximal ideal values of  $(P_z, P_{zz}) = (0,0), (1/3,+1)$  and  $(1/3, +1)$  were used. The deuteron beam polarization has been measured at 270 MeV [21]. The  $dp$ - elastic scattering events at 270 MeV were selected using correlation of the energy losses and time-of-flight difference for deuteron and proton detectors. The values of the beam polarization for different spin have been obtained as weighted averages for 8

scattering angles for  $dp$ - elastic scattering in the horizontal plane only. The typical values of the beam polarization were  $\sim 65$ - $75\%$  from the ideal values.

After deuteron beam polarization measurements at 270 MeV, the beam has been accelerated up to the required energy  $T_d$  between 400 MeV and 1800 MeV. The scintillation detectors were positioned in the horizontal and vertical plane in accordance with the kinematic of  $dp$ - elastic scattering for the investigated energy. The main part of the measurements were performed using  $\text{CH}_2$  target. Carbon target was used to estimate the background. The selection of the  $dp$ - elastic events is done by the correlation of the energy losses in plastic scintillators for deuteron and proton and their time-of-flight difference. The normalized numbers of  $dp$ -elastic scattering events for each spin mode were used to calculate the values of the analyzing powers  $A_y$ ,  $A_{yy}$  and  $A_{xx}$ .

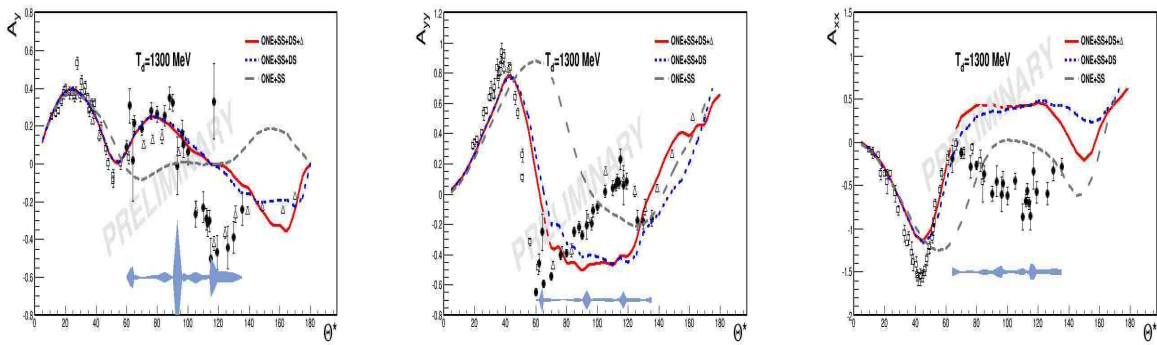

Figure 5: The angular dependencies of the deuteron analyzing powers  $A_y$ ,  $A_{yy}$  and  $A_{xx}$  at the deuteron kinetic energy  $T_d$  of 1300 MeV shown in the left, middle and right panels, respectively. The full squares are the preliminary results of the present DSS experiment at ITS at Nuclotron. Open symbols are the world data. Blue bands are the systematic errors due to  $\text{CH}_2 - \text{C}$  subtraction. Lines are the calculation within relativistic multiple scattering model [32].

The angular dependence of the deuteron vector analyzing power  $A_y$  at the deuteron kinetic energy  $T_d$  of 1300 MeV is presented in the left panel of Fig. 5. The full circles are the results of the present experiment at ITS at Nuclotron. Blue bands are the systematic errors due to  $\text{CH}_2 - \text{C}$  subtraction. Open symbols are the data obtained at Saclay and ANL. The lines are the calculations performed within relativistic multiple scattering model [32] considering ONE+SS terms only and with the DS contribution added and taking into account  $\Delta$ - isobar mechanism, respectively. The contribution of the  $\Delta$ - isobar is significant at backward angles at this energy [27, 32]. One can see good agreement of new data obtained at Nuclotron with the data from earlier experiments. The relativistic multiple scattering model [27, 32] describes the data up to  $\sim 90^\circ$  only, while it fails to reproduce the data at larger angles. The considering of either DS term, nor  $\Delta$ - isobar

improves the agreement. The angular dependencies of the tensor analyzing powers  $A_{yy}$  and  $A_{xx}$  at the deuteron kinetic energy  $T_d$  of 1300 MeV are presented in the middle and right panels of Fig. 5, respectively. The full circles are the results of the present DSS experiment at ITS at Nuclotron. Open triangles and squares are the data obtained at Saclay and ANL, respectively. The lines are the same as show in the left panel. The model allows to describe the behaviour of the  $A_{yy}$  analyzing power up to  $\sim 80^\circ$  only qualitatively. The DS term gives a significant contribution at the angles larger than  $\sim 40^\circ$ , however, its taking into account does not remove the discrepancy of the calculation with the data. The  $A_{xx}$  behaviour is not described by the model [32] over the whole angular range. The reason of the deviation can be the neglecting by the 3N SRCs or more complicated reaction mechanism. One can see also manifestation of the resonant-like structure of the vector  $A_y$  and tensor  $A_{yy}$  analyzing powers in the vicinity of  $100^\circ$ - $130^\circ$ .  $A_y$  reaches -0.4, while  $A_{yy}$  goes to zero. At the moment such behaviour cannot be described by the theory.

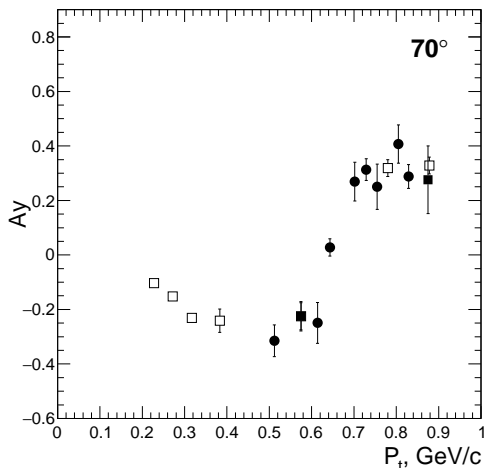

Figure 6: The energy dependence of the vector analyzing power  $A_y$  at  $70^\circ$  in the cms. The full circles are the preliminary results of the DSS experiment. The full squares are the data obtained at ITS at Nuclotron in 2005 [30, 31]. Open symbols are the world data.

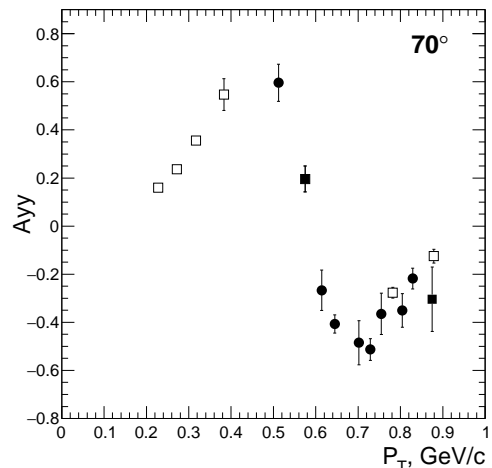

Figure 7: The energy dependence of the tensor analyzing power  $A_{yy}$  at  $70^\circ$  in the cms. The full circles are the preliminary results of the DSS experiment. The full squares are the data obtained at ITS at Nuclotron in 2005 [30, 31]. Open symbols are the world data.

The energy dependencies of the vector  $A_y$  and tensor  $A_{yy}$  analyzing powers at  $70^\circ$  in the cms are presented as a function of the transverse momentum  $P_T$  in Figs 6 and 7, respectively. The full circles are the preliminary results of the present experiment. The full squares are the data obtained at ITS at Nuclotron in 2005 [30, 31]. Open symbols are the world data. Both  $A_y$  and  $A_{yy}$  analyzing powers change the sign at  $P_T \sim 600$  MeV/ $c$  and have the tendencies at larger  $P_T$  to reach the positive and negative constant values, respectively. These features of the data indicate the serious deviation of the spin

structure of the 2N SRCs on the standard description of the nucleon-nucleon interaction. Further theoretical investigations are required to understand the behaviour of the data at large  $P_T$ .

### 3.3 $dp$ - non-mesonic breakup at 400 MeV

The study of  $dp$ - breakup reaction in different kinematic configurations gives an opportunity to select the regions of phase space where the observables are sensitive mostly to 2NF or 3NF. The predictions of the tensor  $A_{yy}$  analyzing power and cross section for  $dp$ - non-mesonic breakup at 400 MeV for different kinematic configurations of the final protons [33] demonstrate such sensitivity to the contribution of 3NF.

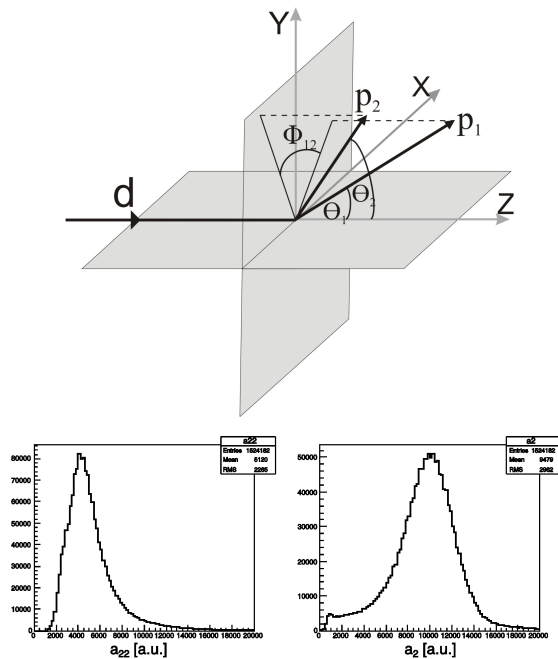

Figure 8: Top:  $\Theta_1$ ,  $\Theta_2$  and  $\Phi_{12}$  - polar and azimuthal angles of particle scattered from the target. Bottom: Amplitude spectra for the PMT-85 and PMT-63 obtained for the one of the arm in the  $pp$  quasi elastic kinematics at  $90^\circ$  cm and deuteron energy of 200 MeV/n.

The  $dp$ - non-mesonic breakup reaction will be investigated using  $\Delta E$ - $E$  techniques for the detection of two final protons [34, 35]. Monte-Carlo simulation shown the feasibility of such techniques for the energies  $T_d \leq 500$  MeV [36]. Each detector consists of 2 scintillation counters: the first and the second ones are with 1 cm and 20 cm scintillators in length, respectively. The diameter of the  $E$ -counter scintillator is 10 cm. Two Photomultiplier tubes PMTs-85 are positioned opposite to each other at the outside cylindrical surface of the thin  $\Delta E$ - scintillator. At the bottom end of the  $E$ - scintillator a photomultiplier tube

PMT-63 is positioned.

The use 8  $\Delta E$ - $E$  detectors simultaneously allows to measure the observables for many kinematic configurations. The angles definition is given in the top panel of Fig.8.

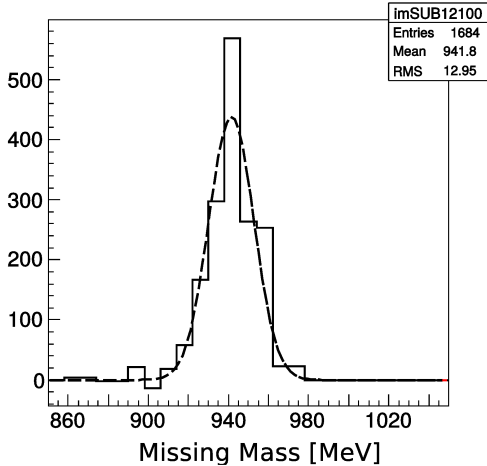

Figure 9: Missing mass spectra with gauss fit ( $941 \pm 11$  MeV) obtained by subtracting of Carbon content from Polyethylene one at angles of  $31^\circ$  and  $43^\circ$  for the particles which are stopped in scintillator at deuteron energy of 200 MeV/n.

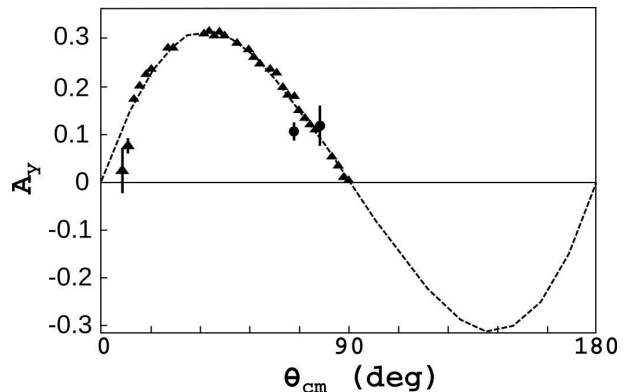

Figure 10: Angular dependence of the vector analyzing power  $A_y$  at energy of 200 MeV/n. Data obtained at Nuclotron at  $72.3^\circ$  and  $76.5^\circ$  in cm are represented by full circles, triangles represent data from [39]. Line is the result of the partial-wave analysis [40].

The energy calibration of the  $\Delta E$ - $E$  detectors have been performed using  $pp$ - quasielastic scattering at 3 energies: 150 MeV/n, 200 MeV/n and 250 MeV/n [37]. PMTs amplitudes are corrected using LED amplitude information. Finally, calibration coefficients are obtained by solving of system of linear equations.  $\Delta E - E$  correlation obtained in the  $pp$  quasi elastic kinematics at  $90^\circ$  cm are in good agreement with geant4 simulation [38] at the same kinematic configuration. Therefore, for future data taking calibration can be performed at only one energy, preferably 200 MeV/n, with using  $\Delta E - E$  dependence from simulation as calibration curve. The Carbon contribution for 300, 400 and 500 MeV is relatively small for the case of calibration measurements and the peak position in Polyethylene and subtracted spectra have the same position within experimental accuracy. Therefore, the calibration can be performed on Polyethylene only.

Missing mass spectra with gauss fit ( $941 \pm 11$  MeV) obtained by subtracting of Carbon content from Polyethylene one at angles of  $31^\circ$  and  $43^\circ$  for the particles which are stopped in scintillator at deuteron energy of 200 MeV/n are shown in Fig.9. Mean value of missing mass spectra for chosen configuration are in agreement with rest mass of neutron. Value of 11 MeV can be assumed as the energy resolution of the detector.

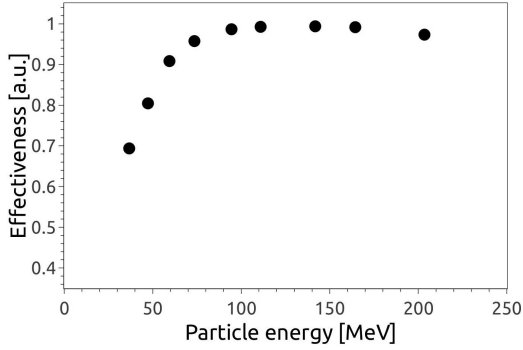

Figure 11: The efficiency of the proton detector by the  $E$  detector as a function of the proton energy.

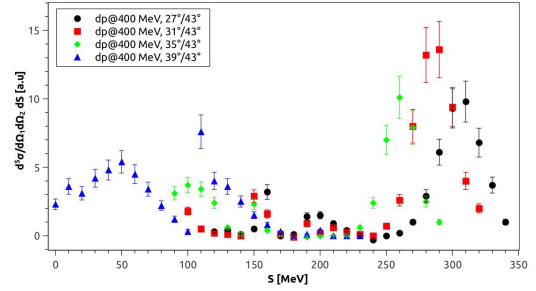

Figure 12: The differential cross section for different configurations for coplanar geometry as a function of the  $S$  variable.

Analyzing power  $A_y$  at  $72.3^\circ$  and  $76.5^\circ$  in the cms was measured at 200 MeV/n under  $pp$ - quasielastic scattering conditions. Obtained values at  $72.3^\circ$  and  $76.5^\circ$  are  $0.10 \pm 0.02$  and  $0.11 \pm 0.06$ , respectively. Results are in agreement with world  $pp$ - elastic scattering data [39] within experimental errors as well as with the result of the partial-wave analysis [40] shown by the solid line in Fig.10.

Values of the vector  $iT_{11}$  and tensor  $T_{20}$  analyzing powers at polar angles of  $34.8^\circ$  and  $36.8^\circ$  and difference in azimuthal angles of  $135^\circ$  were found to be  $0.47 \pm 0.10$  and  $0.02 \pm 0.20$ , respectively [41].

The analysis of the data obtained in  $dp$ - non-mesonic breakup with unpolarized beam for coplanar and space-star configurations is in progress. The efficiency of the proton detection by the  $E$  detector as a function of the proton energy is shown in Fig.11. The differential cross section in a.u. for coplanar geometry as a function of the  $S$  variable for the different proton detectors dispositions are given in Fig. 12 by the black, red, green and blue symbols for  $\theta_1=27^\circ$ ,  $\theta_1=31^\circ$ ,  $\theta_1=35^\circ$  and  $\theta_1=39^\circ$ , respectively. Second detector is placed at the angle of  $\theta_2=43^\circ$ .

FEU-85 and FEU-63 PMTs have been replaced by the Hamamatsu PMTs. The feasibility of the studies for cross section and analyzing powers in  $dp$ - non-mesonic breakup at intermediate energies at ITS with the detection of two protons has been established.

### 3.4 Deuteron and proton polarimetry at Nuclotron

The polarimeter based on the use of  $dp$ - elastic scattering at large angles ( $\theta_{\text{cm}} \geq 60^\circ$ ) at 270 MeV [21], where precise data on analyzing powers [9, 10] exist, and placed at internal target station (ITS) at Nuclotron [20] has been proposed as the reference deuteron

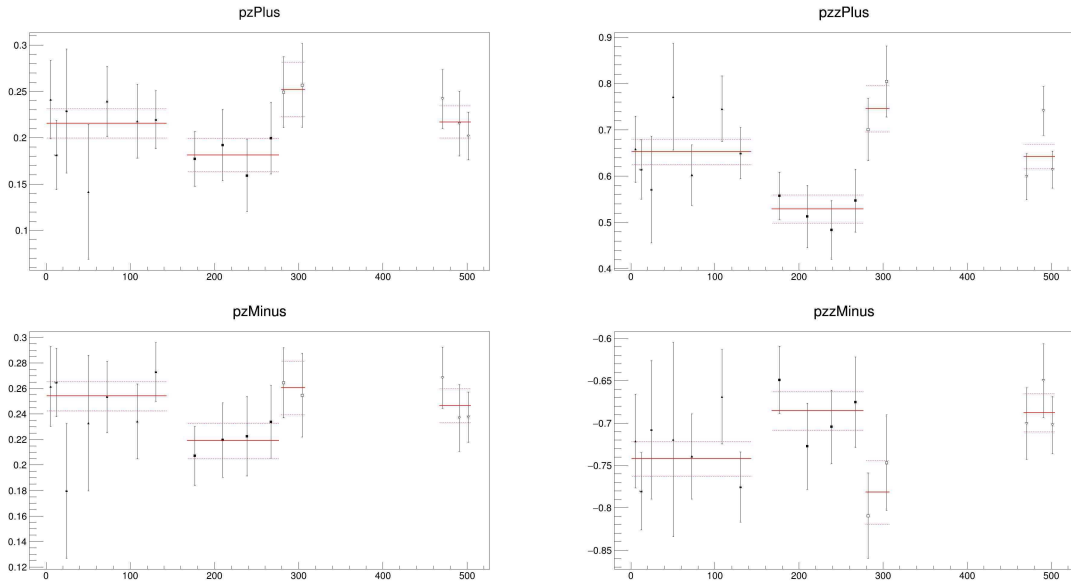

Figure 13: Polarizations values  $P_Z$  and  $P_{ZZ}$  for spin modes  $(P_Z, P_{ZZ}) = (1/3, -1)$  and  $(1/3, +1)$ .

polarimeter at Nuclotron-NICA. The accuracy of the determination of the deuteron beam polarization achieved with this method is better than 2% because of the values of the analyzing powers were obtained for the polarized deuteron beam, which absolute polarization had been calibrated via the  $^{12}\text{C}(d, \alpha)^{10}\text{B}^*[2^+]$  reaction [42]. This polarimeter can work in the counting mode in the energy range of 300–2000 MeV and, therefore, can be used for permanent beam polarization monitoring [19].

The vector and tensor polarizations were measured seven, six and four times in the parts at November-2016, at December-2016 and at February-2017, respectively. The values have small statistical and systematics errors. They are rather stable within each part of the experiment. The results of the measurements of the  $P_Z$  and  $P_{ZZ}$  and their approximation are presented in Fig. 13. All the results are within two standard deviations from these constants. One can see that the beam polarization values are quite stable within more than 200 hour of the SPI operation. On the other hand, SPI demonstrates good reproducibility of the polarization values for different sets of the data after long interruptions. It was found also the value of the  $\beta$  angle, which defines the direction of polarization vector in the space, is about  $-90^\circ$ .

The polarimeter [21] has been used also to tune the SPI [22] operation for pure tensor spin modes  $(0, -2)$  and  $(0, +1)$ , for pure vector spin mode  $(-2/3, 0)$  and for the spin mode  $(-2/3, +1)$  with both vector and tensor components. The typical values of the beam polarization were  $\sim 65\text{-}75\%$  from the ideal values for all 6 spin modes of SPI.

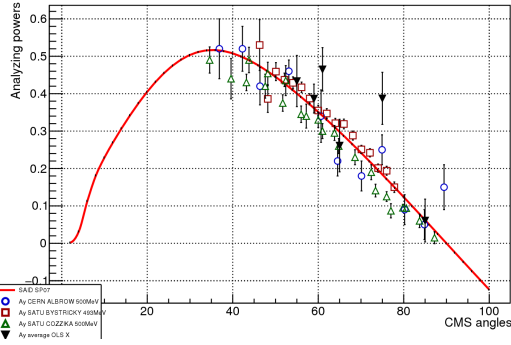

Figure 14: The analyzing power of the  $pp$ - quasi-elastic scattering reaction at the energy of 500 MeV/nucleon. Full symbols are the results of the DSS experiment. Open symbols are the world data. A solid line is the SP07 solution of SAID PWA [40].

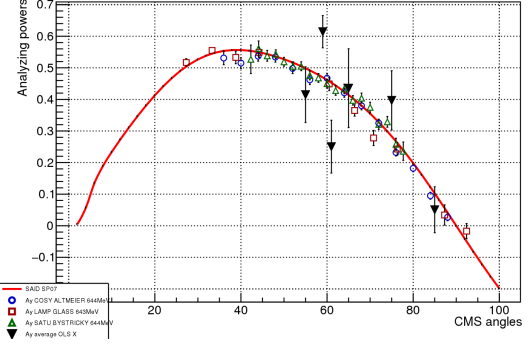

Figure 15: The analyzing power of the  $pp$ - quasi-elastic scattering reaction at the energy of 650 MeV/nucleon. Full symbols are the results of the DSS experiment. Open symbols are the world data. A solid line is the SP07 solution of SAID PWA [40].

The classical method to measure the proton beam polarization at intermediate and high energies is the use of the left-right  $pp$ - elastic or quasi-elastic scattering (see, for instance, [43] and references therein). The maximal value of the analyzing power at the energies below 1000 MeV is close to  $\sim 40^\circ$  in cms [40], that corresponds roughly  $14\text{-}15^\circ$  in the laboratory. Unfortunately, this angle is inaccessible due to design of ITS and detector support.

This method has been modified to increase the polarimeter figure of merit. For this purpose the measurements of the proton beam polarization using several pairs of the detectors placed in the kinematic coincidences corresponding to  $pp$ - elastic scattering in the horizontal plane (orbit plane of Nuclotron) have been proposed. The feasibility of the proposed method at ITS has been checked in November 2016 run at Nuclotron using polarized deuteron beam with the energies of 500 MeV/nucleon and 650 MeV/nucleon. The results on the analyzing power  $A_y$  of the  $pp$ - quasi-elastic scattering reaction at the energies of 500 MeV/nucleon and 650 MeV/nucleon are presented in Fig. ?? and . Fig. ??, respectively. One can see a good consistency of the data obtained at Nuclotron with the world data and SP07 solution of the SAID partial wave analysis (PWA) [40].

The unpolarized and polarized proton beam provided by SPI [22] has been accelerated in March 2017 run up to 500 MeV. The typical intensity of the beam was  $\sim 1.5 \cdot 10^8$  ppp and  $\sim 2\text{-}3 \cdot 10^7$  ppp for unpolarized and polarized cases, respectively. SPI provided proton beam polarization using WFT 1 $\rightarrow$ 3 with ideal value of the polarization  $P=-1$ . The polarization of the proton beam has been obtained using the data from eight pairs of the detectors placed in the kinematic coincidences. The values of the analyzing power for



$pp$  elastic scattering were taken from SAID PWA [40]. The weighted average values of the proton beam polarization were found as  $0.017 \pm 0.021$  and  $-0.354 \pm 0.022$  for unpolarized and polarized cases, respectively. Such value is large enough to perform the measurements of the nucleon analyzing power  $A_y^p$  in  $pd$ - elastic scattering.

### 3.5 Upgrade of the DSS setup

First priority is to develop the proton polarimeter which uses both  $pp$ - and  $pd$ - elastic scattering at 100-1000 MeV. The simulation has been performed to maximize figure of merit. According the simulation results the size of the scintillation detectors has been chosen. The production and testing of  $\sim 40$  detectors based on Hamamatsu PMTs H7415 for  $pp$ - elastic scattering is finished. The results of the amplitude measurements from RA source for one of the detectors are shown in Fig. 16. The mass production of the detectors for  $pd$ - elastic scattering reaction is in progress.

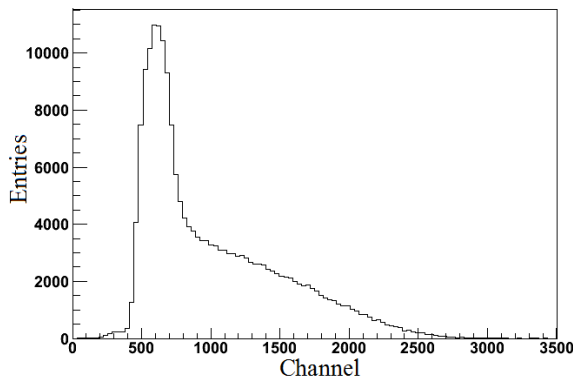

Figure 16: The amplitude signal from RA- source for new scintillation detector.

The 16-Channel scintillation detector with silicon photomultiplier (SiPM) readout has been developed and tested for the proton and deuteron beam polarimetry purposes [44].

Four high aperture thick (10cm) scintillation counters have been obtained as a contribution of FIAN and installed together with the scintillation hodoscopes to enlarge the acceptance and identification for  $dp$ - elastic scattering and  $dp$ - breakup as well as for the studies of SCR in carbon and light nuclei. It is planned to replace the scintillation hodoscopes by  $50 \times 50$  cm<sup>2</sup> straw detectors.

The high energy tensor-vector polarimeters will be based on the  $dp$ - elastic scattering at forward angles where both tensor and vector analyzing powers have large values [45, 46]. The possibility to select the  $dp$ - elastic scattering events using timing and amplitude information from the scintillation counters detected deuterons and protons in the kinematic coincidence has been demonstrated at 1600 MeV and 2000 MeV [47]. The de-

tection system based on the double sided silicon strip detector developed at LHEP JINR [48] can be used for further removing of the carbon content of the  $CH_2$  target. The useful events will be selected by the proton and deuteron scattering angles correlation and coplanarity condition. These selection criteria will significantly reduce the contribution from the carbon content of the  $CH_2$  target. The forward deuteron and recoil proton will be detected by two silicon strip detectors in coincidence. Such detection system is under development.

### 3.6 Analysis of the polarization effects in few-nucleon systems

The relativistic multiple scattering model [15, 16] has been further developed for the  $dp$ -elastic scattering process by taking into account the explicit  $\Delta$ - isobar excitation [27] with the  $\rho$ - exchange in the  $\Delta$ - isobar formfactor [32]. It has been applied for the description of the unpolarized and polarized data in the deuteron energy range between 500 MeV and 2000 MeV.

The next step in the model development is to consider the  $N^*(1440)$ - excitation in the intermediate state as well as possible manifestation of the  $d^*(2180)$  dibaryon. This is very important for the description of the polarization data at large scattering angles.

### 3.7 Publications, talks, thesis

1. The results obtained within *DSS* project in 2019-2020 are published in 3 papers in the regular journals [26],[32], [44].
2. The results have been presented at the international conferences SPIN2018, FB22, AYSS-2019, AYSS-2020, DSPIN-2019, EFB24, LC2019, NUCLEUS-2019, LXX2020, and others in  $\sim 25$  talks [49]-[76].
3. During 2019-2020 2 Master Thesis [77, 78] and 1 PhD Thesis [79] were defended.
4. A talk with the spin effects in  $dp$ - elastic scattering at NICA was given on the first stage physics program at SPD workshop.
5. A chapter with the proposal on the study of the analyzing powers in  $dp$ - elastic scattering at SPD has been prepared [80]

## 4 Request for 2022-2024.

The realization of the *DSS*- project requires beam time at Nuclotron and other resources from JINR side.

### 4.1 The schedule

The collaboration is planning in 2022-2024 to focus on

1. the analysis and publishing of the data obtained with unpolarized (d and C) and polarized (d and p) beams.
2. preparation of the measurements and data taking with nuclear beams in 2022-2024 yy.
3. preparation of the polarization measurements and data taking with polarized deuterons and protons in 2023-2024 y.
4. developments for the deuteron and proton polarimetry at Nuclotron and NICA.

DSS collaboration in 2022-2024 yy. will focus on the studies using ITS. The main goal is the measurements of the analysing powers in *dp*- and *pd*- elastic scattering and in *dp*- and *pd*- non-mesonic breakup. We plan also to perform short methodical measurements for the  $dd \rightarrow {}^3\text{H}p$  at 400 MeV as the first step in the studies of the four-nucleon systems. In parallel the proton and deuteron polarimetry will be developed. For these purposes we expect 2 runs with polarized deuteron and proton beams from new PIS [22]) in 2023-2024 y. Some methodical measurements for the development of the polarimetry will be required using ion beams (mostly parasitic) in 2022 y.

### 4.2 The beam time request

New PIS [22] will allow to have a variety of spin modes. In the experiment we are planning to use the spin modes with the following ideal values of  $(p_z, p_{zz})$ : (0,0), (0,-2), (-2/3,0) and (1/3,+1).

Unfortunately, due to rather low intensity of the polarized deuteron beam, the estimated error bars in the analysing powers in *dp*- elastic scattering obtained during 2016-2017 yy. was only about  $\sim 0.05$  (not  $\sim 0.02$  as it was expected). On the other hand, low energy part (300 MeV -700 MeV) was not measured. Therefore, during next term the calibration data at the energies of 300 MeV–700 MeV will be obtained with an interval of

50 MeV. These data are very important to study the 3NF spin structure. The calibration of the deuteron beam ITS polarimeter at high energies will be performed at 1.6 GeV only, where the data on the full set of analyzing powers exist [46], together with the calibration of the polarimeter at the extracted beam.

The required beam time for the calibration was evaluated in ref.[19] for the solid angle of each detector of 2.2 msr. The cross section decreases with a beam energy by a factor of 20 from 270 MeV to 2.0 GeV. This decrease is compensated by an increase of luminosity due to smaller energy loss of higher energy particle and by an increase of repetition rate of Nuclotron. Consequently, the expected yield is almost independent from the beam energy.

Since we are limited by the use of thin CH<sub>2</sub> target the maximal available intensity is  $\sim 5 \cdot 10^9$  /spill. For determination of tensor analyzing power with a statistical uncertainty of  $\Delta A = 0.02$ , one needs  $10^4$  counts for one detector. This takes  $\sim 12$  hours for 4 polarization modes including the time for tuning of the beam, changing of the detector position etc. Our request is **100** hours for 2023.

The studies of  $dp$ - non-mesonic breakup will be performed after the measurements of  $dp$ - elastic scattering. For these purposes we need the maximal available intensity of  $\sim 5 \cdot 10^9$  /spill. The major goal is to perform the measurements in the complanar geometry at 400 MeV [33]. The estimated time for this purpose is **100** hours for 2023-2024.

The proton beam polarization was measured as  $\sim 0.35$  [?]. This value can be increased by the tuning of the spin precessor of SPI [22]. We are planning to perform the measurements of the nucleon analyzing power  $A_y^p$  in  $pd$ - elastic scattering in the energy range between 100 MeV/n and 1000 MeV/n using the coincidence techniques. We expect the error bar of  $\Delta A_y^p \sim 0.02$  in the measurements at 14 proton energies: 100, 150, 200, 250, 300, 350, 400, 440, 500, 600, 700, 800, 900 and 1000 MeV. The estimated beam time request is **150** hours for the intensity of  $\sim 5 \cdot 10^9$  /spill. For this task we need to prepare CD<sub>2</sub> target, new mechanics and part of new scintillation counters. This task is strongly overlap with the goal of the proton beam polarimetry based on  $pp$ - quasielastic scattering, which will require **50** hours in 2023-2024.

In 2022 we need about 300 hours of the beam time with ions to test the setup for  $pp$ - and  $pd$ - measurements. Part of this time can be in parasitic mode.

Total beam time request for 2022-2024 is presented in table 1.

\* part of the beam time in parasitic mode.

Table 1: Beam-time request for *DSS*- project.

Year	Particles	Time (hours)
2022	ions	300*
2023	$\vec{d}+\vec{p}$	200
2024	$\vec{d}+\vec{p}$	200
TOTAL		700

### 4.3 JINR budget request

The JINR budget money request for 2022-2024 is 140k\$ (see table 2). We expect 104k\$ for the equipment (registration electronics, HV system, mechanics, computing etc.) and 36k\$ for the travel and staying expenses.

## 5 Conclusions

During 2022-2024 we expect to obtain the following results.

1. The final data analysis on the systematic measurements of the cross section,  $A_y$ ,  $A_{yy}$  and  $A_{xx}$  analyzing powers in  $dp$ - elastic scattering at the energies 270-1800 MeV will be performed. Several papers for regular journals will be prepared.
2. The data on the deuteron and proton beam polarization during will be analyzed and published.
3. New detection system for the measurements with polarized protons will be prepared and tested.
4. The deuteron analyzing powers in  $dp$ - elastic scattering will be obtained at the energies of 300 MeV–700 MeV with an interval of 50 MeV. These data are very important to study the 3NF spin structure.
5. The vector-tensor polarimeter will be calibrated at 300 MeV–700 MeV and 1600 MeV with the expected error bars for analyzing powers  $\pm 0.02$ .
6. First data on the analyzing powers in  $dp$ - non-mesonic breakup in the coplanar geometry at 200 MeV/n will be obtained.
7. The efficient proton beam polarimetry based on  $pp$ - elastic scattering will be developed at the energies of 100 MeV–1000 MeV.
8. The first measurements of the nucleon analyzing power in  $pd$ - elastic scattering will be performed at the energies of 100 MeV–1000 MeV.

9. The first measurements of the nucleon analyzing power in  $dp$ - non-mesonic breakup in the complanar geometry at 200 MeV/n will be started.
10. The studies of the  $dd \rightarrow {}^3He p$  reaction will be started at 200 MeV/n.
11. The theoretical analysis of the observables in hadronic reactions with the participation of light nuclei will be continued.

## References

- [1] L. Frankfurt, M. Sargsian, M. Strikman, Int.J.Mod.Phys.**A23** (2008) 2991.
- [2] E. Piassetzky, M. Sargsian, L. Frankfurt, M. Strikman, J.W. Watson, Phys.Rev.Lett. **97** (2006) 162504.
- [3] L.L. Frankfurt, M.I. Strikman, D.B. Day, M.M. Sargsian, Phys.Rev. **C48** (1993) 2451.
- [4] K.Sh. Egiyan et al., Phys.Rev. **C68** (2003) 014313.
- [5] K.S. Egiyan et al., Phys.Rev.Lett. **96** (2006) 082501.
- [6] L. Frankfurt, M. Sargsian, and M. Strikman, AIP Conf.Proc.**1056**, 322 (2008).
- [7] W. Glöckle, H. Witala, D. Hüber, H. Kamada, J. Golak, Phys.Rep. **274** (1996) 107.
- [8] N. Sakamoto et al., Phys.Lett. **B367** (1996) 60.
- [9] K. Sekiguchi et al., Phys.Rev. **C65** (2002) 034003.
- [10] K. Sekiguchi et al., Phys.Rev. **C70**, 014001 (2004).
- [11] K. Hatanaka, Y. Shimizu et al., Phys.Rev. **C66**, 044002 (2002).
- [12] R. Bieber et al., Phys. Rev. Lett. **84**, 606 (2000).
- [13] K. Ermisch et al., Phys. Rev. Lett. **86**, 5862 (2001).
- [14] K. Ermisch et al., Phys. Rev. **C68**, 051001 (2003).
- [15] N.B. Ladygina, Phys.Atom.Nucl. **71** (2008), 2039; N.B. Ladygina, e-Print: arXiv:0805.3021[nucl-th].
- [16] N.B. Ladygina, Eur.Phys.J. A42 (2009) 91.
- [17] V.I. Kukulín et al., J. Phys. G: Nucl. Part. Phys. **30**, 287 (2004).

- [18] Ladygin V.P.// Proc. of the XV-th Int.Sem. on High Energy Physics Problems, 25-29 September 2000, Dubna, Russia, Eds. A.M.Baldin, V.V.Burov and A.I.Malakhov, Dubna:JINR. 2001. V.2. P.301.
- [19] T. Uesaka, V.P. Ladygin et al., Part.Nucl.Lett. 3[114] N°5 (2006), 58.
- [20] A.I. Malakhov, et al., Nucl.Instr.Meth. in Phys.Res. **A440** (2000) 320; Yu.S. Anisimov, et al., Proc. of the 7-th Int. Workshop on Relativistic Nuclear Physics, 25-30 August 2003, Stara Lesna, Slovak Republic, p.117.
- [21] P.K. Kurilkin et al., Nucl.Instr.Meth. in Phys.Res. **A642** (2011) 45.
- [22] V.V. Fimushkin et al., J.Phys.Conf.Ser. **678** (2016) 012058.
- [23] Yu.V.Gurchin et al., Phys.Part.Nucl.Lett. **4** (2007) 263.
- [24] A.A.Terekhin et al., Phys.Part.Nucl.Lett. **12** (2015) 695.
- [25] A.A.Terekhin et al., Phys.Atom.Nucl. **80** (2017) 1061.
- [26] A.A.Terekhin et al., The differential cross section in deuteron-proton elastic scattering at 500, 750 and 900 MeV/nucleon, Eur.Phys.J. **A55** (2019) 129.
- [27] N.B.Ladygina, Eur.Phys.J. **A52** (2016) 199.
- [28] V.A. Matveev et al. Lett. Nuovo Cimento **7** (1973) 719.
- [29] A.Yu.Isupov et al., Nucl.Instrum.Meth. **A698** (2013) 127.
- [30] P.K. Kurilkin et al., Phys.Lett. B **715** (2012) 61.
- [31] P.K. Kurilkin et al., Phys.Part.Nucl.Lett. **8** (2011) 1081.
- [32] N.B.Ladygina, On reaction mechanisms in deuteronproton elastic scattering, Eur.Phys.J. **A56** (2020) 5, 133.
- [33] J. Kuros-Zolnierchuk et al., *nucl-th/0203017v1* (2002).
- [34] S.M. Piyadin et al., Phys.Part.Nucl.Lett. **8** (2011) 107.
- [35] S.M. Piyadin et al., Int.J.Mod.Phys. A26 (2011) 683.
- [36] V.P. Ladygin and S. Nedev, Part. and Nucl. Lett. **2[111]-2002** (2002) 13.
- [37] M.Janek et al., Phys.Part.Nucl.Lett. **15** (2018) 76.
- [38] M.Janek et al., Phys.Part.Nucl.Lett. **11** (2014) 552.

- [39] S.Rahm et al., Phys. Rev. C **57** (1998) 1077.
- [40] <http://gwdac.phys.gwu.edu>
- [41] M.Janek et al., iT11 and T20 analyzing powers of  $dp \rightarrow ppn$  reaction at 400 MeV investigated at Nuclotron, Communications: Scientific Letters of the University of Zilina **19** (2017) 62.
- [42] K. Suda et al., Nucl.Instr.Meth. in Phys.Res. **A572** (2007) 745.
- [43] L.S. Azhgirey et al., Nucl.Instrum.Meth. in Phys.Res. **A497** (2003) 340.
- [44] A.V.Tishevskiy et al., Study of the 16-Channel Scintillation Detector Prototype with Silicon Photomultiplier Readout, Phys.Atom.Nucl. **83**, 12 (2020) 1691.
- [45] M. Bleszynski et al., Phys.Lett. **B87** (1979) 178.
- [46] V. Ghazikhanian et al., Phys.Rev. **C43** (1987) 1532.
- [47] Yu.V. Gurchin et al., Phys.Part.Nucl.Lett. **8** (2011) 566.
- [48] A.V. Isaev et al., PTE **1** (2011) 43.
- [49] V.P. Ladygin et al., Spin Studies of the Short-Range Correlations with Polarized Beams at JINR-Nuclotron, In Proceedings of the 8-th International Conference on Quarks and Nuclear Physics (QNP2018), JPS Conf. Proc. **26** (2019) 023023.
- [50] V.P.Ladygin et al., Spin studies of the short-range correlations at Nuclotron, In Proceedings of the 23-rd International Spin Symposium, 10-14 September 2018, Ferrara, Italy, PoS (SPIN2018) (2019) 023.
- [51] V.P.Ladygin et al., Deuteron and proton beams polarimetry at internal target at JINR Nuclotron, In Proceedings of the 23-rd International Spin Symposium, 10-14 September 2018, Ferrara, Italy, PoS (SPIN2018) (2019) 150.
- [52] A.Isupov, VMEbased DAQ system for the Deuteron Spin Structure setup at the Nuclotron internal target station, In Proceedings of the XXIV-th International Baldin Seminar on High Energy Physics Problems "Relativistic Nuclear Physics and Quantum Chromodynamics", 17-22 September 2018, Dubna, Russian Federation, EPJ Web Conf. **204** (2019) 10003.
- [53] A.A.Terekhin et al., The differential cross section for dp-elastic scattering at 500-900 MeV/n, In Proceedings of the XXIV-th International Baldin Seminar on High Energy Physics Problems "Relativistic Nuclear Physics and Quantum Chromodynamics", 17-22 September 2018, Dubna, Russian Federation, EPJ Web Conf. **204** (2019) 10010.



- [54] O.Mezhenska et al., Study of the deuteron analyzing powers in dp elastic scattering at the energy of 800 MeV, In Proceedings of the XXIV-th International Baldin Seminar on High Energy Physics Problems "Relativistic Nuclear Physics and Quantum Chromodynamics", 17-22 September 2018, Dubna, Russian Federation, EPJ Web Conf. **204** (2019) 10001.
- [55] Ya.T. Skhomenko et al., Deuteron beam polarimeter at Nuclotron internal target, In Proceedings of the XXIV-th International Baldin Seminar on High Energy Physics Problems "Relativistic Nuclear Physics and Quantum Chromodynamics", 17-22 September 2018, Dubna, Russian Federation, EPJ Web Conf. **204** (2019) 10002.
- [56] V.P.Ladygin et al., Energy dependence of the vector  $A_y$  and tensor  $A_{yy}$  and  $A_{xx}$  analyzing powers in deuteron- proton elastic scattering at large scattering angles, In Proceedings of the XXIV-th International Baldin Seminar on High Energy Physics Problems "Relativistic Nuclear Physics and Quantum Chromodynamics", 17-22 September 2018, Dubna, Russian Federation, EPJ Web Conf. **204** (2019) 01019.
- [57] N.B.Ladygina, Reaction mechanisms in deuteron-proton elastic scattering at intermediate energies, In Proceedings of the 22-th International Conference on Few-Body Problems in Physics, 9-13 July 2018, Caen, France, Recent Progress in Few-Body Physics, Springer Proc. Phys. **238** (2020), chapter 72, pp.445-448, Springer Nature Switzerland AG 2020, Eds. N.A.Orr, M.Ploszajczak, F.M.Marques, J.Carbonell.
- [58] M.Janek et al., Experimental study of few nucleon correlations using deuteron beam at Nuclotron, In Proceedings of the 22-th International Conference on Few-Body Problems in Physics, 9-13 July, 2018 Caen, France, Recent Progress in Few-Body Physics, Springer Proc. Phys. **238** (2020), chapter 81, pp.493-496, Springer Nature Switzerland AG 2020, Eds. N.A.Orr, M.Ploszajczak, F.M.Marques, J.Carbonell.
- [59] O. Mezhenska et al., Measurement of the vector and tensor analyzing powers for dp- elastic scattering at the energy of 800 MeV, AIP Conference Proceedings **2163** (2019) 030011.
- [60] Ya. Skhomenko et al., Deuteron beam polarization measurement at 270 MeV at Nuclotron internal target, EPJ Web Conf. **201** (2019) 04005.
- [61] A.A.Terekhin et al., Studying the Differential Cross Section of Elastic Deuteron-Proton Scattering at 12 GeV, Bull.Russ.Acad.Sci.Phys. **84** (2020) 6, pp.747.
- [62] N.Ladygina, Study of deuteron-proton backward elastic scattering at intermediate energies, In Proceedings for the 24-th European Few Body Conference, 2-4 September 2019, Surrey, UK, SciPost Phys.Proc. **3** (2020) 053.

- [63] M.Janek et al., Latest results concerning short range correlations obtained in the dp elastic and dp breakup processes at Nuclotron, JINR, In Proceedings for the 24-th European Few Body Conference, 2-4 September 2019, Surrey, UK, SciPost Phys.Proc. **3** (2020) 011.
- [64] O.Mezhenska et al., Study of the polarization observables in dp- $\gamma$ dp reaction at the energy of 800 MeV, In Proceedings of the XVIII-th Workshop on High Energy Spin Physics (DSPIN19), 2-7 September 2019, Dubna, Russian Federation, submitted to J.Phys.Conf.Ser. **1435** (2020) 012042.
- [65] M.Janek et al., Cross section investigation in dp breakup reaction at the intermediate energies, In Proceedings of the XVIII-th Workshop on High Energy Spin Physics (DSPIN19), 2-7 September 2019, Dubna, Russian Federation, submitted to J.Phys.Conf.Ser. **1435** (2020) 012013.
- [66] Ya.T.Skhomenko et al., The results of the deuteron beam polarization measurement for dp- elastic scattering reaction at 270 MeV energy, In Proceedings of the XVIII-th Workshop on High Energy Spin Physics (DSPIN19), 2-7 September 2019, Dubna, Russian Federation, submitted to J.Phys.Conf.Ser. **1435** (2020) 012050.
- [67] V.P.Ladygin et al., Deuteron analyzing powers in dp -elastic scattering at large transverse momenta, In Proceedings of the XVIII-th Workshop on High Energy Spin Physics (DSPIN19), 2-7 September 2019, Dubna, Russian Federation, submitted to J.Phys.Conf.Ser. **1435** (2020) 012039.
- [68] A.A.Terekhin et al., Upgrade of the polarimeter at the Internal Target Station at the Nuclotron, In Proceedings of the XVIII-th Workshop on High Energy Spin Physics (DSPIN19), 2-7 September 2019, Dubna, Russian Federation, submitted to J.Phys.Conf.Ser. **1435** (2020) 012051.
- [69] M.Janek et al., Angular and energy dependence of  $A_y$ ,  $A_{yy}$  and  $A_{xx}$  analyzing powers in dp elastic scattering and dp breakup reaction investigation, In Proceedings of the LC2019 - QCD on the light cone: from hadrons to heavy ions, 16-20 September 2019, Ecole Polytechnique, Palaiseau, France, PoS LC2019 (2020) 048.
- [70] O.Mezhenska et al., Dp breakup reaction investigation at intermediate energies at Nuclotron, Proceedings of the XXIV International Scientific Conference of Young Scientists and Specialists (AYSS-2020), 9-13 November 2020, JINR, Dubna, Russia, submitted to AIP Conf.Proc.
- [71] I.S.Volkov et al., Analyzing power in quasi-elastic proton-proton scattering at 500 and 650 MeV/nucleon, Proceedings of the XXIV International Scientific Conference

- of Young Scientists and Specialists (AYSS-2020), 9-13 November 2020, JINR, Dubna, Russia, submitted to AIP Conf.Proc.
- [72] A.A.Terekhin et al., New proton polarimeter at the Nuclotron, Proceedings of the XXIV International Scientific Conference of Young Scientists and Specialists (AYSS-2020), 9-13 November 2020, JINR, Dubna, Russia, submitted to AIP Conf.Proc.
- [73] A.V.Tishevskiy et al., Study of the 16-channel scintillation detector prototype with SiPM readout, Proceedings at the XXIV International Scientific Conference of Young Scientists and Specialists (AYSS-2020), 9-13 November 2020, JINR, Dubna, Russia, submitted to AIP Conf.Proc.
- [74] V.P.Ladygin et al., Angular dependencies of the deuteron analyzing powers in dp-elastic scattering at large transverse momenta, Proceedings of the LXX International conference "NUCLEUS 2020. Nuclear physics and elementary particle physics. Nuclear physics technologies", 11-17 October 2020, Saint Petersburg, Russia, to be published in Phys.Part.Nucl.
- [75] M.Janek et al., SHORT-RANGE CORRELATION INVESTIGATION IN DEUTERON INDUCED REACTIONS, talk at the Konferencia Českých a Slovenských fyziků, 7-10 September 2020, Praha, Czech Republic.
- [76] M. Janek, V.P. Ladygin, S. M. Piyadin, Properties of detectors used in dp breakup experiment investigated at intermediate energies, ELEKTRO-2020 conference, 25-28 May 2020, Žilina, Slovak Republic, IEEE (2020). s.[1-4], ISBN 978-1-7281-7541-6.
- [77] I.S.Volkov, Investigation of deuteron- proton scattering asymmetry at internal beam at JINR Nuclotron, Master Thesis, defended in 2019, Belgorod National Research University, Belgorod, Russia.
- [78] Maroš Krasňan, Determining the position of a particle in a neutron detector: design and filling algorithm, Diploma Thesis, defended in 2020, Faculty of Electrical Engineering and Information Technology, Žilina University, Žilina, Slovak Republic.
- [79] A.A.Terekhin, Investigation of the differential cross section of the dp- elastic scattering reaction at the energies 1-2 GeV, PhD Thesis, defended in 2020, LHEP JINR, Dubna, Russia.
- [80] V.V.Abramov et al., Possible studies at the first stage of the NICA collider operation with polarized and unpolarized proton and deuteron beams, e-Print:2102.08477 [hep-ph], submitted to Phys.Part.Nucl.

## Appendix A.

Table 2: Estimate of the JINR budget expences in 2022-2024 for the *DSS*- project: Probing the *Deuteron* short-range *Spin Structure* in the (d,p) reactions using polarized deuteron beam at Nuclotron.

$N^0$	Name of the expences	Total cost	2022	2023	2024
	Direct expences	140.0	50.0	50.0	40.0
1.	Accelerator, Nuclotron	700	300*	200	200
2.	Computer(type)				
3.	Computer network				
4.	Constructor bureau (hours)	300	100	100	100
5.	Model shop (hours)	500	200	200	100
6.	Matherials	60.0	22.0	22.0	16.0
7.	Equipment	44.0	16.0	16.0	12.0
8.	Payment of SEW, made on the agreements				
9.	Travel expences, including	36.0	12.0	12.0	12.0
	a) countries of the non-rouble zone	21.0	7.0	7.0	7.0
	b) countries of the rouble zone	15.0	5.0	5.0	5.0
	c) travels on the contracts				

\*- part of the beam time can be delivered in parasitic mode.

## Appendix B. SWOT analysis for the *DSS-* project.

**Strengths:** The strong points of the *DSS-* project are the unique physics related with the studies of the short-range correlations spin structure, development of the efficient polarimetry for the deuteron and proton beams, contribution to the first stage physics program at SPD. The project is an inevitable step for spin program at NICA.

**Weaknesses:** Very high competition for the beam at Nuclotron due to higher priority of the heavy ion program.

**Opportunities:** Project provides visible role for young scientists, real possibility to defense the thesis (5 PhD thesis and  $\sim 15$  Master thesis).

**Threats:** COVID-19 pandemy impact is related with the absence of the exchanges which reflects on the speed of the data analysis and publishing and possible cancellation of the european and japaneze phycisists participation in data taking at Nuclotron.

## Appendix C.

Table 3: Estimate of human resources for the *DSS*- project.

N <sup>o</sup>	Name	FTE	Duty
1.	E.V. Chernykh	0.9	Electronics, data taking
2.	Yu.V.Gurchin	1.0	Detectors, data taking and analysis
3.	A.Yu.Isupov	0.7	DAQ, data taking and analysis
4.	A.N. Khrenov	0.5	Detectors, mechanics
5.	V.P.Ladygin	0.5	Management, data taking and analysis
6.	N.B.Ladygina	0.9	Data analysis and interpretation
7.	A.N.Livanov	0.1	ITS support, data taking
8.	S.G.Reznikov	0.7	Trigger, electronics, data taking
9.	A.A.Terekhin	1.0	Simulation, data taking and analysis
10.	A.V.Tishevsky	1.0	Detectors, data taking and analysis
11.	I.S.Volkov	1.0	Simulation, data taking and analysis
		<b>8.3</b>	