

**High Acceptance Di-Electron Spectrometer (HADES)  
(JINR participation)**

JINR participants:

A.V.Belyaev, O.V.Fateev, A.P.Ierusalimov, V.V.Ivanov, G.I.Lykasov, V.P.Ladygin,  
S.A.Lebedev, S.G.Reznikov, A.Yu.Troyan, A.I.Zinchenko

Participating institutes:

*Joint Institute for Nuclear Research, Dubna, Russia*

*Institute of Physics, Slovak Academy of Sciences, Bratislava, Slovakia*

*Istituto Nazionale di Fisica Nucleare - Laboratori Nazionali del Sud, Catania, Italy*

*LIP-Laboratório de Instrumentação e Física Experimental de Partículas, Coimbra, Portugal*

*Smoluchowski Institute of Physics, Jagiellonian University of Cracow, Cracow, Poland*

*GSI Helmholtzzentrum für Schwerionenforschung GmbH, Darmstadt, Germany*

*Technische Universität Darmstadt, Darmstadt, Germany*

*Institut für Strahlenphysik, Helmholtz-Zentrum Dresden-Rossendorf, Dresden, Germany*

*Institut für Kernphysik, Goethe-Universität, Frankfurt, Germany*

*Physik Department E12, Technische Universität München, Garching, Germany*

*II.Physikalisches Institut, Justus Liebig Universität Giessen, Giessen, Germany*

*Institute for Nuclear Research, Russian Academy of Science, Moscow, Russia*

*Institute of Theoretical and Experimental Physics, Moscow, Russia*

*Department of Physics, University of Cyprus, Nicosia, Cyprus*

*Institut de Physique Nucléaire, CNRS/IN2P3 - Université Paris Sud, Orsay, Cedex, France*

*Nuclear Physics Institute, Academy of Sciences of Czech Republic, Rez, Czech Republic*

*LabCAF. F. Física, Univ. de Santiago de Compostela, Santiago de Compostela, Spain*

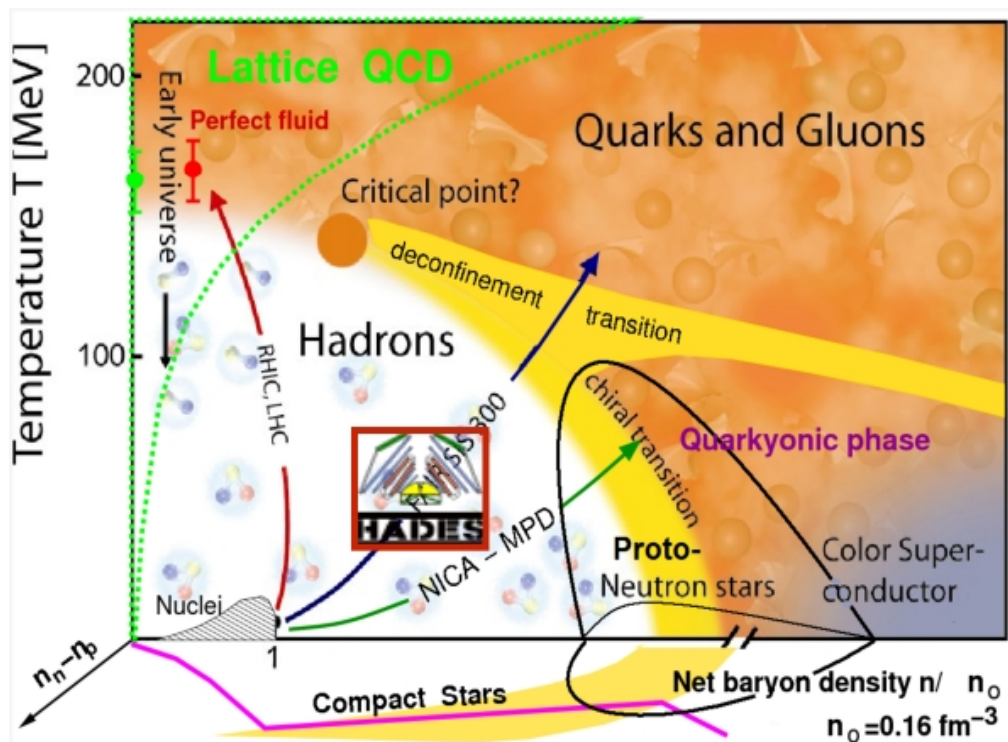
*Instituto de Física Corpuscular, Universidad de Valencia-CSIC, Valencia, Spain*

Project leaders: Ladygin V.P., Fateev O.V.

## The High Acceptance Di-Electron Spectrometer at SIS18

HADES is a versatile detector for a precise spectroscopy of  $e^+e^-$  pairs (dielectrons) and charged hadrons produced in proton, pion and heavy ion induced reactions in a 1-3.5 GeV kinetic beam energy region. The detector has been set-up at GSI, Darmstadt. The main experimental goal is to investigate properties of dense nuclear matter created in the course of heavy ion collisions and ultimately learn about in-medium hadron properties (like masses, decay widths). The matter created in such collisions differs from the one studied at SPS, RHIC or LHC because it consists mainly of baryons (nucleons and its excited states- baryon resonances) and little mesons and can be compressed up to 3 times nuclear matter density for about 10-12 fm/c. Dielectron pairs originating from in-medium hadron decays and rare strange hadrons (kaons, hyperons) are the main probes measured in the experiment. Since conclusions on in-medium effects rely strongly on the understanding of hadron properties in vacuum and their production mechanism in nucleon-nucleon collisions a complementary program focusing on  $e^+e^-$ , kaon and hyperon ( $\Sigma$ ,  $\Lambda$ ) production in elementary collisions is also in progress.

Collisions of heavy ions allow to probe nuclear matter at high densities and temperatures. These studies have the astrophysical applications, namely, the composition, equation of state- mass-radius relation for compact massive stars (supernova and neutron stars). Dense nuclear matter can be created in relativistic heavy-ion collisions. The baryon density and the temperature of the fireball reached in such collisions depend on the beam energy. The phases of strongly interacting matter are shown schematically in figure 1. The "liquid" phase is realized in atomic nuclei at zero temperature and at saturation density (300 million tons/cm<sup>3</sup>). At low densities, the nucleons (i.e. protons and neutrons) behave like a gas. As the temperature and the density are raised, the nucleons are excited into "baryon resonances" which subsequently decay into pions and nucleons.



**Figure 1:** A schematic phase diagram of strongly interacting matter.

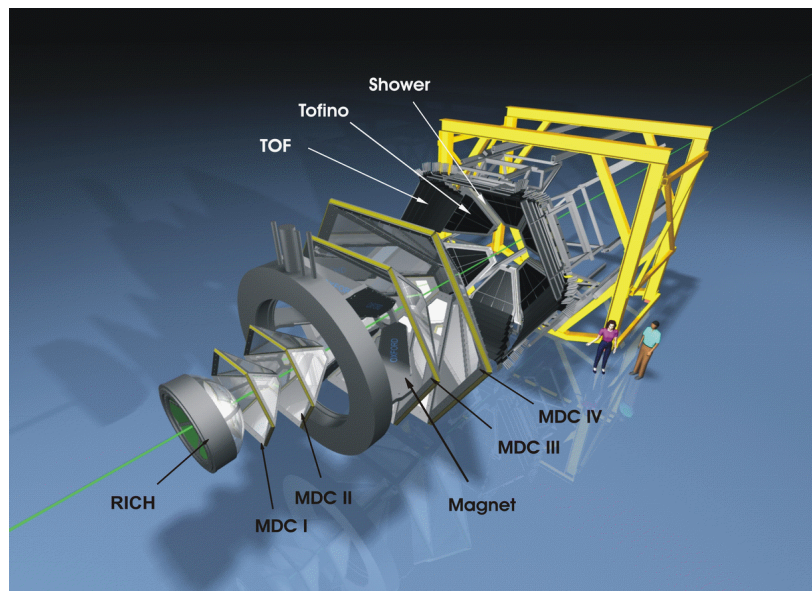
This mixture of nucleons, baryonic resonances and mesons is called hadronic matter. In highly compressed cold nuclear matter - as it may exist in the interior of neutron stars - the baryons also lose their identity and dissolve into quarks and gluons. The critical density at which this transition occurs, however, is not known. The same is true for the entire high-density area of the phase diagram. At very high densities and low temperatures, beyond the deconfinement transition, a new phase is expected: the quarks are correlated and form a color superconductor. At the "critical point" the deconfinement/chiral phase transition is predicted to change its character.

The physics motivation for HADES includes the investigation of in-medium modification of light vector mesons as well as the study of dilepton continuum in the warm ( $T < 100 \text{ MeV}$ ) and dense (up to  $3\rho_0$ ) hadronic matter at SIS18, GSI. Due to good hadron identification the studies of the strange particles including so-called multistrange hyperons ( $\Lambda$ ,  $\Xi$ ,  $\Omega$ ) and hypernuclei are possible. The HADES strategy is the systematic di-electron and hadron measurements in NN, AA, pA,  $\pi$ N and  $\pi$ A collision.

In future HADES will be a part of the CBM (Compressed Baryonic Matter) experiment at the Facility for Antiproton and Ion Research (FAIR). The CBM experiment will enable researchers to investigate, among other things, processes in supernovae and neutron stars with unprecedented precision. The HADES spectrometer after upgrade will be able to study nuclear reactions in the energy range from 2 to 10 GeV/nucleon.

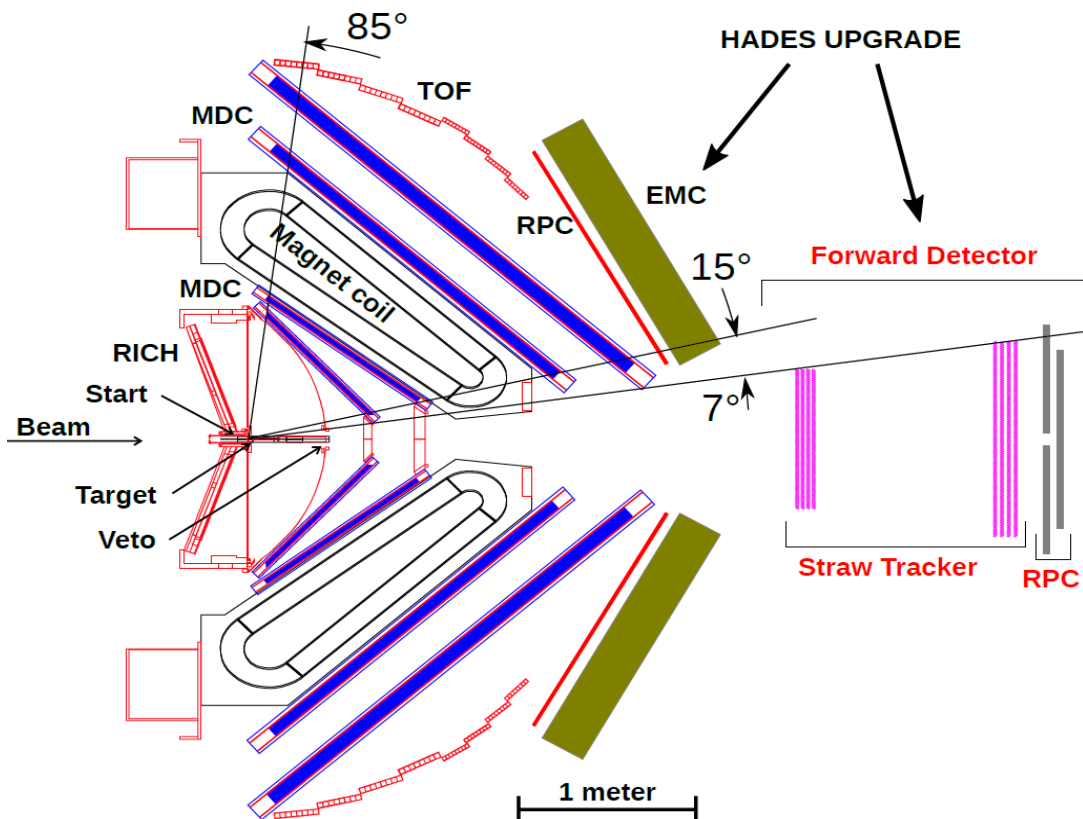
## The HADES detector

The HADES spectrometer is devoted to the 2-nd generation of the di-electron detectors and it is designed to detect these electron-positron pairs heavy ion collisions, which provide information about the properties of the quark-antiquark pairs. The HADES is also able to detect and identify the hadrons what gives the opportunity to study strangeness and multi-pion production. The schematic view of the HADES detector is presented in figure 2.



**Figure 2:** A schematic view of the HADES detector. Magnet is a superconducting toroid, MDC I-IV are the four planes of the multi-drift chambers, RICH is a Ring Imaging Cherenkov detector, Shower is a the pre-shower detector, TOF and TOFINO are the scintillation counters and Resistive Plate Chambers for time-of-flight measurements.

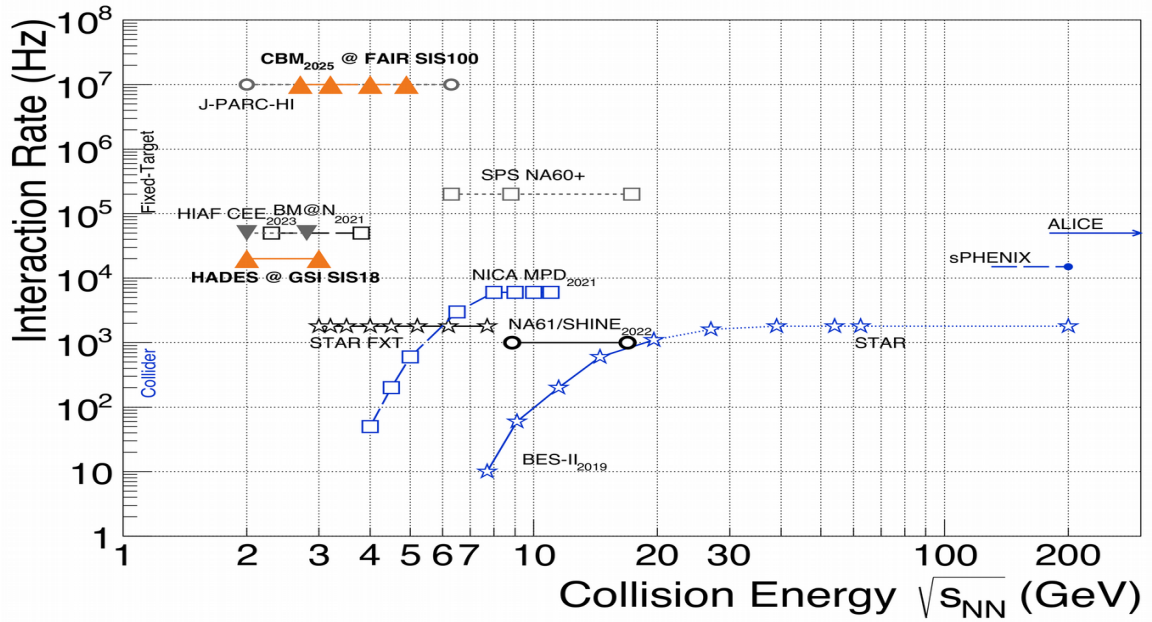
HADES is a large acceptance magnetic spectrometer operating with proton, deuteron and heavy ion beams extracted from the SIS18. It uses directed beam from the synchrotron or optionally secondary pion beams produced in a production target 15 m upstream from the HADES target point. It combines a magnetic spectrometer with detector systems specialized in detecting rare decay products such as electrons and positrons from conversion decays of hadrons. The spectrometer features a sophisticated superconducting toroid, low-mass drift chambers, a ring-imaging Cherenkov detector and lead-glass electromagnetic calorimeter (based on OPAL calorimeter). The time-of-flight system uses diamond start detectors and scintillator and resistive plate based stop detectors. A tracking system consists of a set of 6 superconducting coils producing a toroidal field and drift chambers and a multiplicity and electron trigger array for additional electron-hadron discrimination and event characterization. A two-stage trigger system enhances events containing electrons. The detector system is characterized by an 85% azimuthal coverage over a polar angle interval from 18 to 85 degree, a single electron efficiency of 50% and a vector meson mass resolution of 2.5%. Identification of pions, kaons and protons is achieved combining time-of-flight and energy loss measurements over a large momentum range. The details of the HADES spectrometer are described elsewhere [1]. In addition the Forward Wall (FW) [2] is used for the measurements of the spectator protons and reaction plane determination for heavy-ion and deuteron-proton collisions studies. The schematic cut view of the HADES for the proton-proton experiment in 2022-2023 is shown in figure 3.



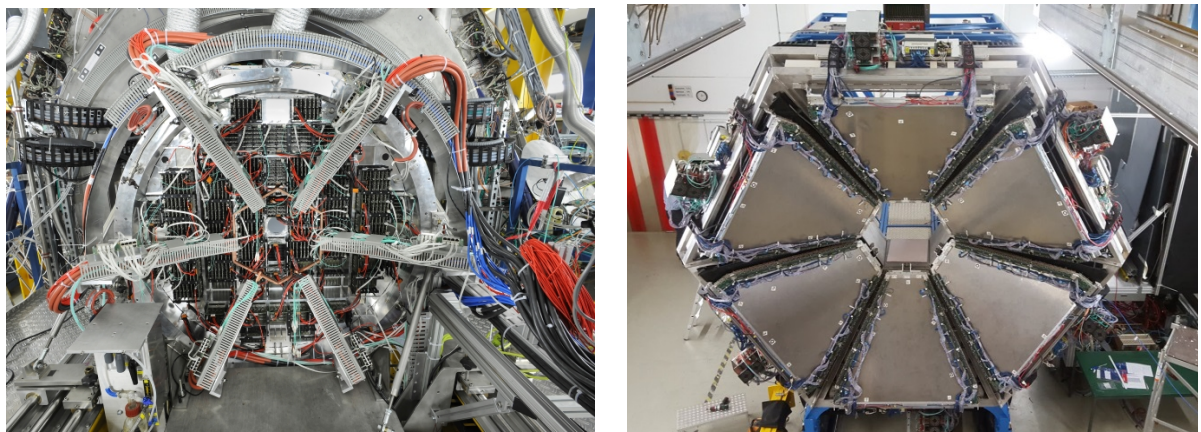
**Figure 3:** A schematic view of the HADES for the proton-proton experiment in 2022-2023 data taking campaign.

The major HADES upgrades for the Ag+Ag collisions studies at 1.58 GeV and 1.23 GeV in 2019 were the installation of new RICH based on the use of Hamamatsu H12700 multianode photomultipliers (part of CBM Phase0 activity), 2 sectors of the lead-glass electromagnetic

calorimeter, new diamond start detector and modernized DAQ system with the rate capability up to 20 kHz of useful events. The interaction rate of the Au+Au collision events as a function of the collision energy for the existing and future facilities is shown in figure 4. Current HADES stored events capability is shown by the yellow triangles. New RICH and ECAL detectors are shown in the left and right panels of figure 5, respectively.



**Figure 4:** The interaction rate of the Au+Au collision events as a function of the collision energy for the existing and future facilities. Current HADES event rate capability is shown by the yellow triangles.



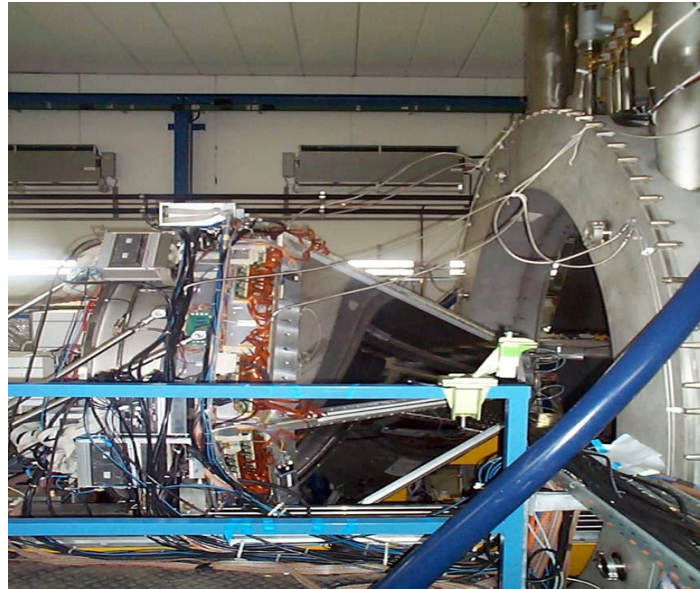
**Figure 5:** Upgraded RICH (left) and new lead glass ECAL (right).

New equipment is under preparation for the data taking campaign in 2022 on proton-proton collisions at 4.5 GeV (see Fig.3). It includes 2 straw detectors stations with PASTTRECK

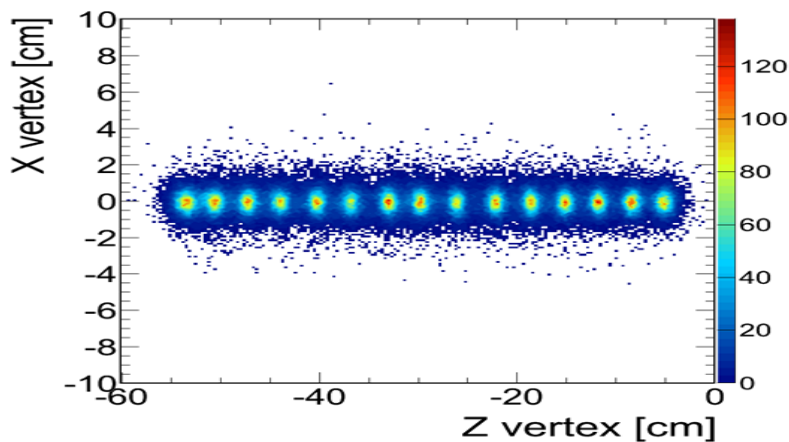
FEE chips and RPC for particles identification covering forward direction acceptance; new T0 in-beam detector based on LGAD technology and iTOF scintillation detector with APD readout to enhance the trigger purity.

### JINR contribution in HADES detector

A tracking system of HADES consists of a set of 6 superconducting coils producing a toroidal field and 4 planes of multi-wire drift chambers (MWDCs) [3,4]. The JINR physicists were responsible for the design, production and maintenance of the 2-nd plane of low mass multi-wire drift chambers [5,6]. Each plane contains 6 separate modules with 6 chambers with different wire orientations. The intrinsic space resolution of the 2-nd plane was achieved as  $57\ \mu\text{m}$  and  $112\ \mu\text{m}$  for the Y and X coordinates, respectively. This plane is used as a reference plane in the tracking procedure. Cathode and field wires are produced from aluminium. The FEE electronics for drift chambers has been developed also at JINR [7]. The picture of the 2-nd MWDC plane installed at HADES detector is shown in figure 6.



**Figure 6:** 2-nd MWDC plane installed at HADES spectrometer.

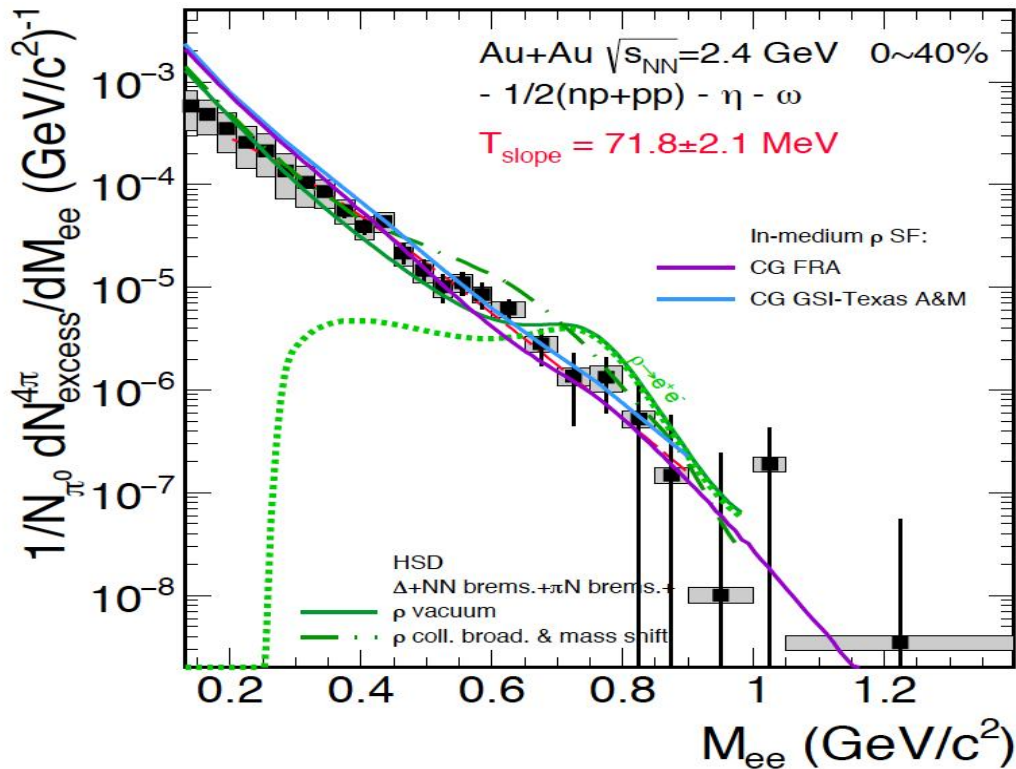


**Figure 7:** The reconstructed Z position of the segmented Au target (15 segments).

JINR physicists developed tracking software for the momentum and vertex reconstruction [8]. The results on the primary vertex reconstruction for the segmented Au target is shown in figure 7. One can see clearly 15 segments with 2 mm in diameter each. JINR participated also in the development of the alignment procedure for HADES [9].

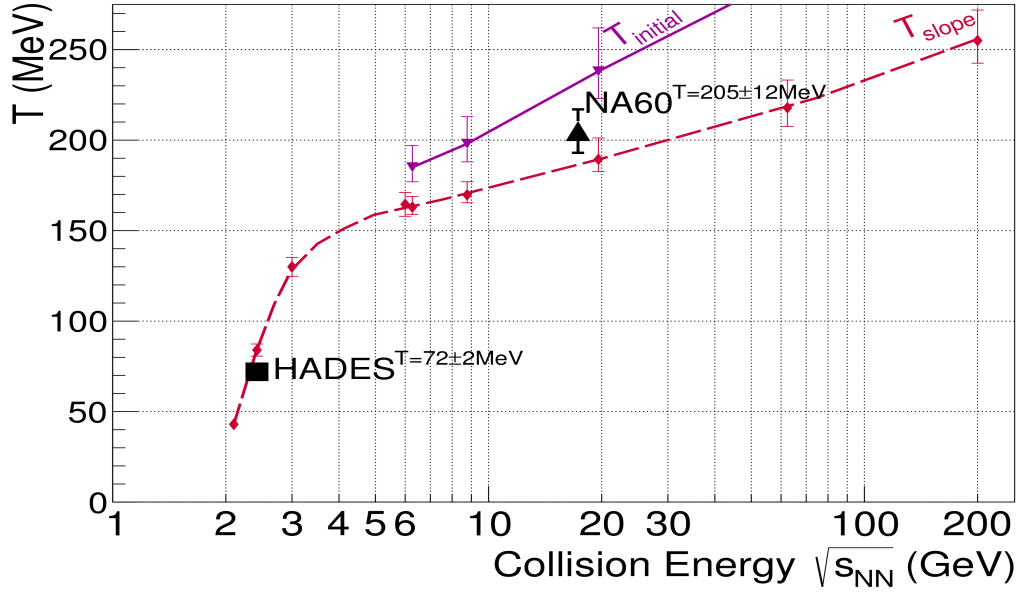
## Recent experimental results from HADES

The main scientific direction of HADES program is the systematic studies of the vector meson production and di-lepton continuum in the  $e^+e^-$  mode. The measured emission of  $e^+e^-$  pairs from C+C collisions at an incident energy of 1 A GeV, spanning from the  $\pi^0$ -Dalitz to the  $\rho/\omega$  invariant-mass region, display a strong excess above the cocktail of standard hadronic sources (6.3. times) [10]. The bombarding-energy dependence of this excess is found to scale like pion production, rather than like eta production. The invariant-mass spectrum of the  $e^+e^-$  pairs produced in C+C collisions at an incident energy of 2 A GeV [11] also demonstrates the excess by 2 times in the  $M_{ee}$  range of 0.15-0.6  $\text{GeV}/c^2$ . The data are in good agreement with results obtained in the former DLS experiment [12,13]. The detailed studies of the origin of the DLS «puzzle» motivated the measurements of electron pair production in elementary p+p and d+p reactions at 1.25 GeV/u with the HADES spectrometer [14]. For the first time, the electron pairs were reconstructed for n+p reactions by detecting the proton spectator from the deuteron breakup by Forward Wall [8]. We find that the yield of electron pairs with invariant mass  $M_{ee} > 0.15 \text{ GeV}/c^2$  is about an order of magnitude larger in n+p reactions as compared to p+p. A comparison to model calculations demonstrates that the production mechanism is not sufficiently described yet. The electron pair spectra measured in C+C reactions were found being compatible with a superposition of elementary n+p and p+p collisions, leaving little room for additional electron pair sources in such light collision systems.

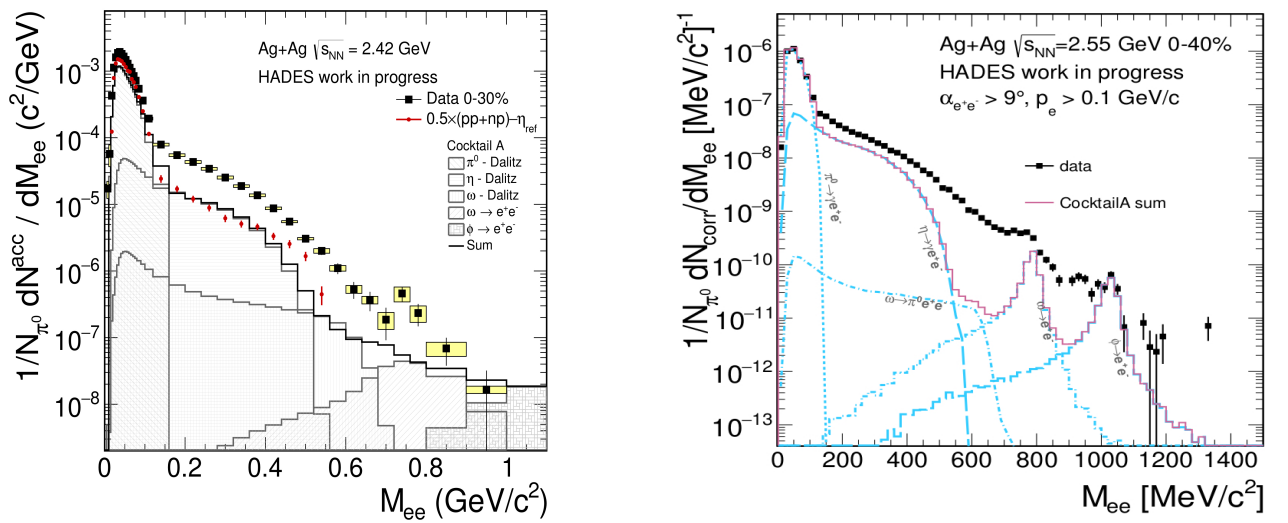


**Figure 8.** The di-electron yield for Au+Au reaction at 1.23 AGeV obtained with HADES [16]. The solid lines are the cocktail calculations for different models without  $\eta$ - and  $\omega$ - mesons contribution. The dashed line is the contribution of the  $\rho$ -meson decay.

For the first time  $\omega$  mesons were reconstructed in a heavy-ion reaction at a bombarding energy which is well below the production threshold in free nucleon-nucleon collisions in dielectron production in Ar+KCl collisions obtained by HADES at 1.76 AGeV [15]. The omega multiplicity has been extracted and compared to the yields of other particles, in particular of the  $\phi$  meson. At intermediate  $e^+e^-$  invariant masses, a strong enhancement of the pair yield over a reference spectrum from elementary nucleon-nucleon reactions was found suggesting the onset of non-trivial effects of the nuclear medium. Transverse-mass spectra and angular distributions have been reconstructed in three invariant mass bins. In the former unexpectedly large slopes are found for high-mass pairs. The latter, in particular the helicity-angle distributions, are largely consistent with expectations for a pair cocktail dominated at intermediate masses by  $\Delta$ -Dalitz decays.

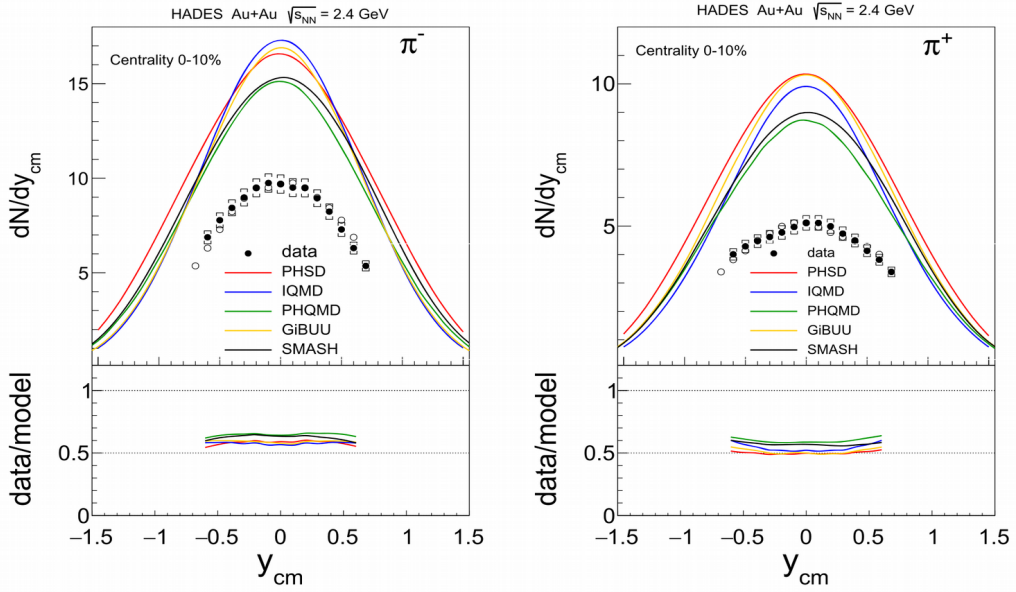


**Figure 9.** The slope of the di-electron yield for Au+Au reaction. The full square is the data obtained with HADES [16]. The curves are the theoretical predictions.

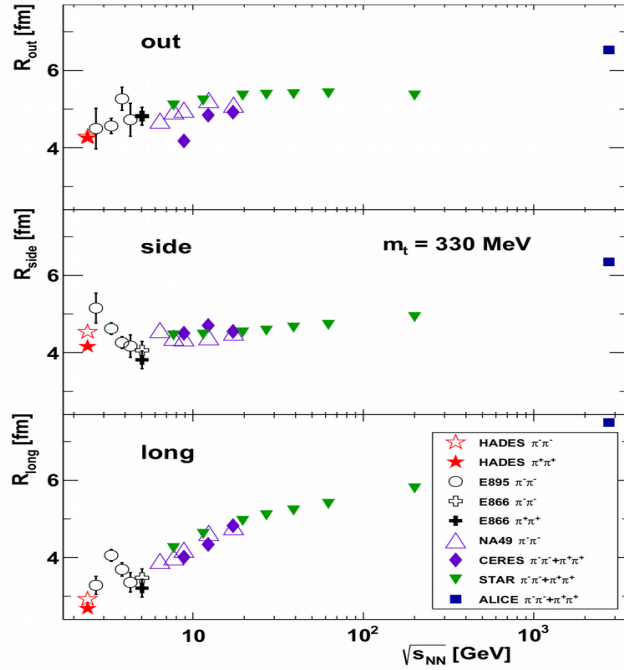


**Figure 10.** Preliminary data on the di-electron yield for Ag+Ag reaction at 1.23 A GeV (left) and 1.55 A GeV (right) obtained with HADES in 2019. The solid lines are the cocktail calculations for different models without  $\eta$ - and  $\omega$ - mesons contribution.





**Figure 11.** Rapidity distributions of negatively (left) and positively (right) charged pions in comparison with the results of five transport models [17].



**Figure 12.** Excitation function of the source radii  $R_{out}$  (upper panel),  $R_{side}$  (central panel), and  $R_{long}$  (lower panel) for the azimuthally-integrated correlation function of pairs of identical pions with transverse mass of  $m_t = 330$  MeV in central (0-10%) collisions of Au + Au or Pb + Pb.

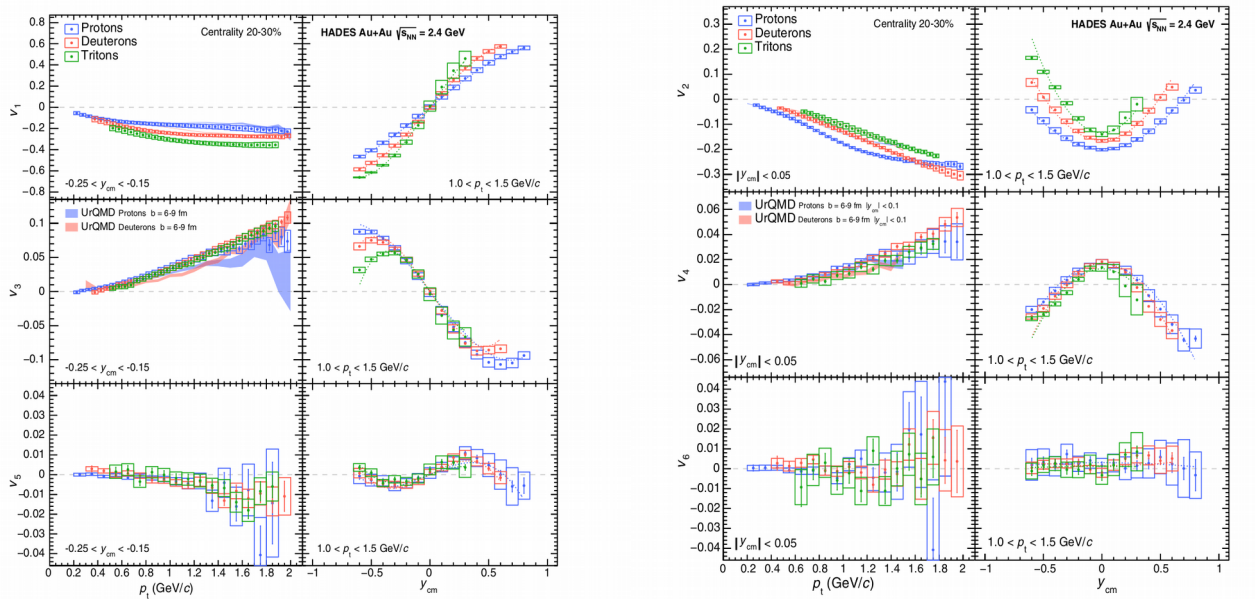
The di-electron yield obtained for Au+Au reaction at 1.23 AGeV at HADES [16] is shown in figure 8. The solid lines are the cocktail calculations for different models without  $\eta$ - and  $\omega$ - mesons contribution. The dashed line is the contribution of the  $\rho$ -meson decay. The data are

described satisfactorily taking into account in-medium modification of  $\rho$ -meson. The slope of the di-electron yield for Au+Au reaction as a function of the collision energy is shown in figure 9. The full square is the data obtained with HADES [16]. The lines are the theoretical predictions. The energy range covered by HADES corresponds to the fast increasing of the slope parameter value with the collision energy increasing. In this respect, the beam energy scan of the di-lepton production at SIS18 is of great importance.

Preliminary data on the di-electron yield for Ag+Ag reaction at 1.23 A GeV and 1.55 A GeV obtained with HADES in 2019 are shown in the left and right panels in figure 10, respectively. The solid lines are the cocktail calculations for different models without  $\eta$ - and  $\omega$ -mesons contribution. The data are in progress now.

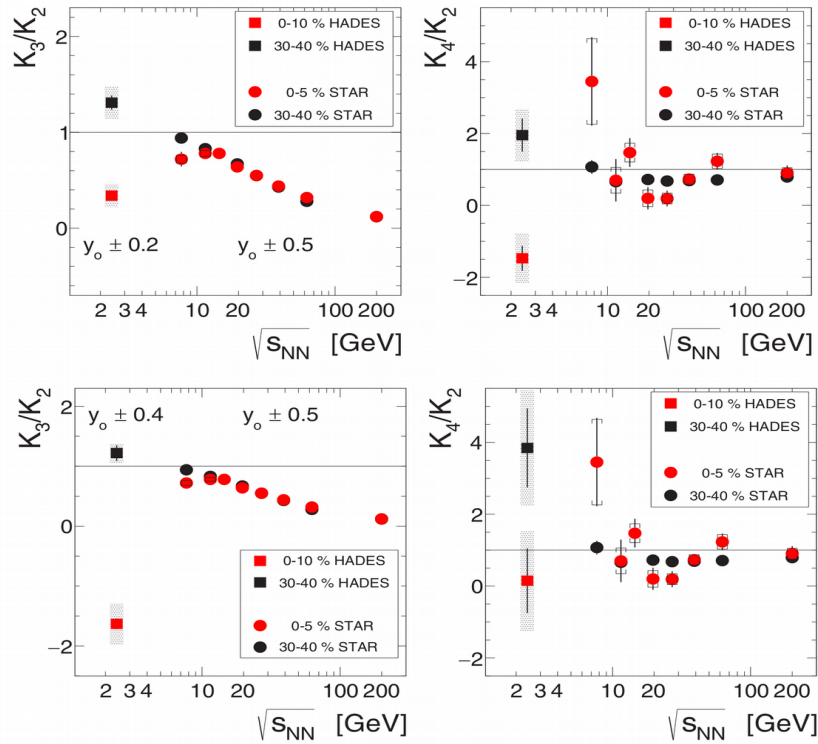
Rapidity distributions of negatively and positively charged pions obtained for Au+Au reaction at 1.23 A GeV [17] in comparison with the results of five transport models are shown in figure 11. Full points are the measured data and open points are the data reflected at  $y_{cm} = 0$ . The comparison is done for the 10% most central events. The ratio of experimental over model data is displayed in the lower panels. All models over-predict the pion multiplicity obtained at HADES significantly.

High-statistics  $\pi-\pi-$  and  $\pi+\pi+$  HBT data for Au + Au collisions at 1.23 A GeV are demonstrated in figure 12 [18,19] by the red stars. The three-dimensional Gaussian emission source is studied in dependence on transverse momentum and collision centrality. It is found to follow the trends observed at higher collision energies, extending the corresponding excitation functions towards very low energies. For all centralities and transverse momenta, a geometrical distribution of ellipsoidal shape is found in the plane perpendicular to the beam direction with the larger extension perpendicular to the reaction plane. For large transverse momenta, the corresponding eccentricity approaches the initial eccentricity. The eccentricity is smallest for most central collisions, where the shape is almost circular. The magnitude of the tilt angle of the emission ellipsoid in the reaction plane decreases with increasing centrality and increasing transverse momentum. All source radii increase with centrality, largely exhibiting a linear rise with the cube root of the number of participants. A substantial charge-sign difference of the source radii is found, appearing most pronounced at low transverse momentum. The extracted source parameters are consistent with the extrapolation of their energy dependence down from higher energies.



**Figure 13.** The odd  $v_1$ ,  $v_3$ , and  $v_5$  (left) and  $v_2$ ,  $v_4$ , and  $v_6$  (right) flow coefficients for protons, deuterons, and tritons in semicentral (20%–30%) Au+Au collisions at 1.23 A GeV.

Flow coefficients  $v_n$  of the orders  $n=1-6$  measured with HADES for protons, deuterons, and tritons as a function of centrality, transverse momentum, and rapidity in Au+Au collisions at 1.23 A GeV [20] are shown in figure 13. Combining the information from the flow coefficients of all orders allows us to construct for the first time, at collision energies of a few GeV, a multidifferential picture of the angular emission pattern of these particles. It reflects the complicated interplay between the effect of the central fireball pressure on the emission of particles and their subsequent interaction with spectator matter. The high precision information on higher order flow coefficients is a major step forward in constraining the equation of state of dense baryonic matter.



**Figure14.** Au + Au data: Evolution of the scaled cumulants  $K_n / K_2$  as a function of center-of-mass energy  $\sqrt{s_{NN}}$  for two centrality bins (0–10% or 0–5%, red symbols, and 30–40%, black symbols) and shown as  $y_1 \times \sigma$  (left column) and  $y_2 \times \sigma^2$  (right column) [21].

The efficiency and volume-corrected proton number moments and cumulants  $K_n$  of orders  $n = 1, 2, 3$ , and 4 have been obtained as a function of centrality and phase-space bin, as well as the corresponding correlators  $C_n$  for 1.23 A GeV Au+Au HADES data [21]. It has been found that the observed correlators show a power-law scaling with the mean number of protons, indicative of mostly long-range multiparticle correlations in momentum space. A comparison of HADES results with Au + Au collision data obtained at RHIC at similar centralities but higher energies are shown in figure 14.

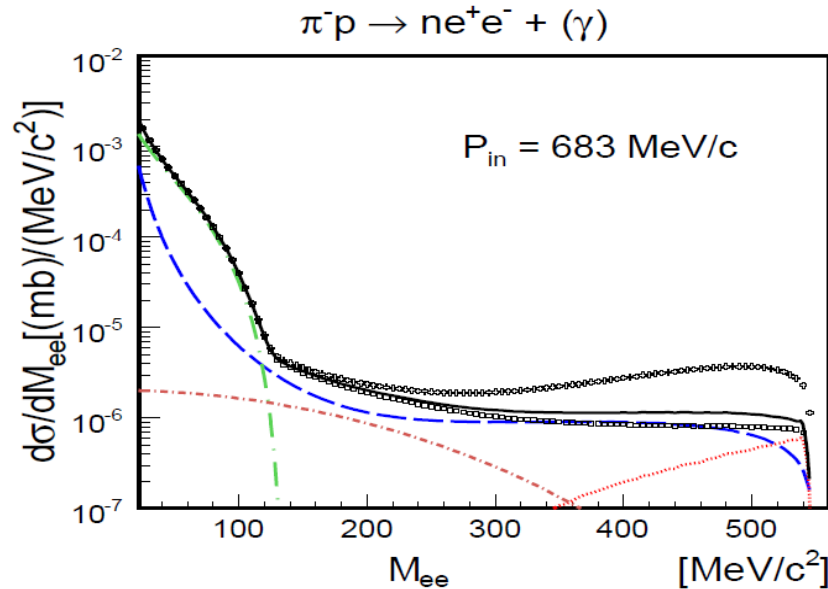
First results on the sub-threshold neutral kaons and lambda-hyperons in Au+Au at 1.23 A GeV have been obtained [22]. The universal scaling with number of participants for all particles containing strangeness, independent of the corresponding excess energy. This implies

that the fireballs created in Au + Au collisions at different centralities are more interrelated than expected and the total amount of strangeness increases stronger than linear with the number of participants and might be redistributed to the final hadron states only at freeze-out. Previous constraints on the EOS of nuclear matter based on the assumption of energy accumulation in sequential nucleon-nucleon collisions should therefore be revisited.

New results have been published on the first observation of  $K^-$  and  $\phi$  absorption within nuclear matter by means of  $\pi^-$ -induced reactions on C and W targets at an incident beam momentum of 1.7 GeV/c studied with HADES [23]. The measured  $\phi/K^-$  ratio within the HADES acceptance is 0.55-0.63 for both targets. Stronger absorption of  $K^-$  and  $\phi$  on W target is observed. This demonstrates that both resonant and nonresonant channels are affected in the medium in the same way. Two-pion production in the second resonance region in  $\pi$ -p collisions with HADES at incident pion momenta of 0.650, 0.685, 0.733, and 0.786 GeV/c [24]. These new data have been included in the Bonn-Gatchina PWA accounting for many other reaction channels measured in various experiments, studying pion- and photoinduced reactions. The preliminary results on the time like transitions in pion- and proton- induced reactions at HADES has been reported and published [25,26].

Correlated pion-proton pair emission off hot and dense QCD matter in Au+Au at 1.23 A GeV has been investigated in vicinity of  $\Delta$  resonance mass [27]. The study of pion-nucleon correlated pairs gives access to the collision dynamics. A feasibility studies of the production and electromagnetic decay of hyperons with HADES including the new Forward Detector, as a Phase-0 experiment at FAIR in proton- proton collisions at 4.5 GeV has been performed [28]. Such measurements will provide complementary information on hyperon structure and the role of strange quarks in baryons.

## JINR group data analysis participation



**Figure 15.** Invariant mass distribution for dielectrons,  $d\sigma/dM_{ee}$ , produced in the reaction  $\pi^-p \rightarrow e^+e^- n(\gamma)$ . The curves correspond to different model parameters and formfactors [29].

JINR group is developing the theoretical approach for dielectron production in the  $\pi N$  interaction at intermediate energies is studied at different momenta [29]. The dominant contribution of the  $\Delta$ -isobar creation in the intermediate state at incident pion momenta of about 0.3-0.4 GeV/c is shown. The experimental distributions over the angle and effective mass  $M_{e^+e^-}$

of the  $e^+e^-$  pair are described satisfactorily. This stimulated to present theoretical predictions for the  $M_{e^+e^-}$  distribution in the process  $\pi^-p \rightarrow ne^+e^-$  at different incident momenta for the reactions  $\pi^-p \rightarrow ne^+e^-$  and  $\pi^-p \rightarrow ne^+ e^- \gamma$  at energies less than 1 GeV is studied assuming electron-positron pair production to occur in the virtual time-like photon splitting process [29]. Invariant mass distribution for dielectrons,  $d\sigma/dM_{e^+e^-}$ , produced in the reaction  $\pi^-p \rightarrow e^+e^- n(\gamma)$  at 683 MeV/c is shown in figure 15. The curves correspond to different model parameters and formfactors [29].

JINR team participates also in the analysis of multi-pion production in nucleon-nucleon reactions in a GeV energy range [30]. Simulation of two-pion production in proton-proton collisions at 3.5 GeV and 4.5 GeV has been performed within OPER model. The self-consistent approach based on similarity of inclusive spectra of hadrons produced in pp and AA collisions has been applied to describe the pion production at HADES energies [31]. The satisfactory description of the pion pt-spectra in pp and AA collisions within this approach is shown.

### JINR group MWDC-II maintenance and upgrade in 2019-2021



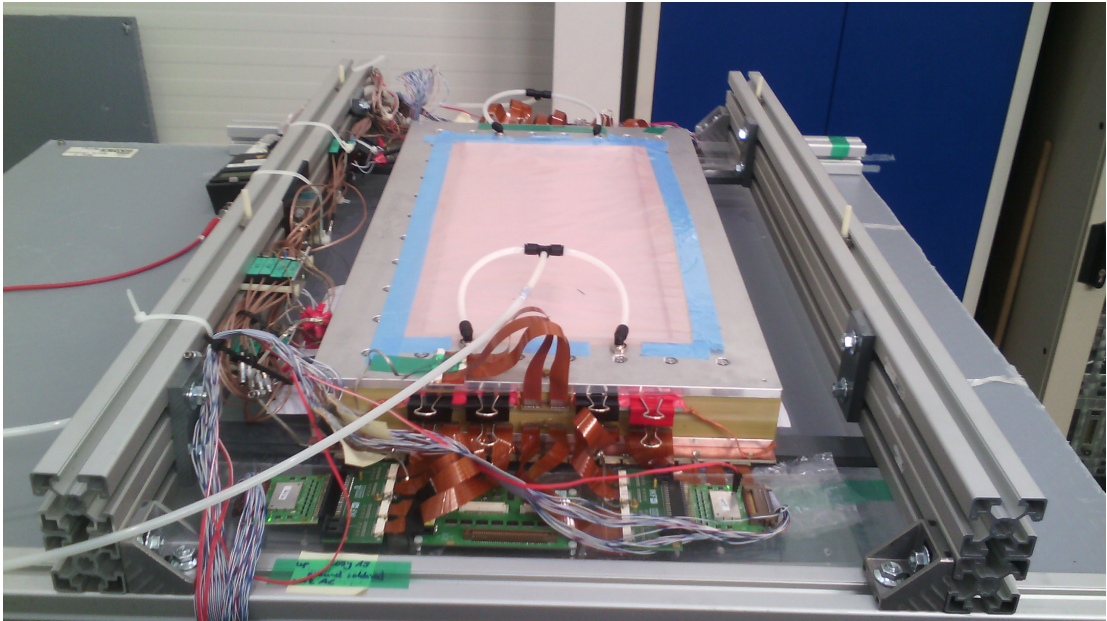
**Figure 16:** The repairing procedure of one of the Dubna MWDC-II sector at GSI.

Physics program of HADES at SIS18 and FAIR demands high detection standards, meaning in precision and also stability of the tracking system comprising four layers of planar drift chambers (MDC-I - IV). Built in the end of 1990s the drift chambers operate started with a gas mixture of helium/isobutane (60/40) to gain the lowest material budget for the HADES detector. Later the gas was changed to Argon/isobutane (84/16) to increase the primary ionization. During the beam-time in 2012 (Au+Au reactions at  $T_{kin} = 1.23$  AGeV) massive wire aging occurred, revealing in the Malter-Effect causing self sustained currents. Therefore, isobutane tending to polymerize was substituted and finally Ar/CO<sub>2</sub> (70/30) is used to prevent further aging in high load experiments. Since 2013 MDC II operating at high voltage of -1770 V (drift cell size  $6 \times 5$  mm<sup>2</sup>) and H<sub>2</sub>O additive to recover stability. An overall stable operation was observed with the admixture of 1000-3000 ppm water vapor to the counting gas, tested in beam

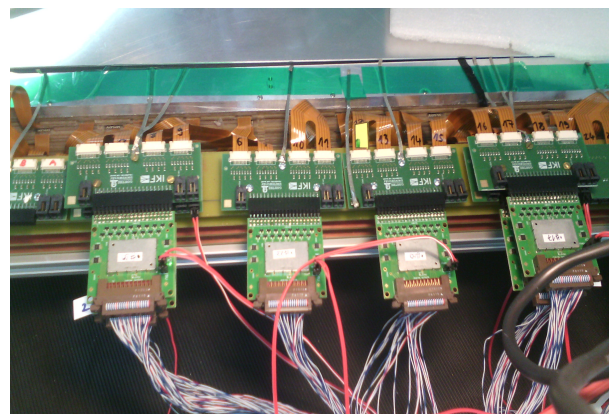
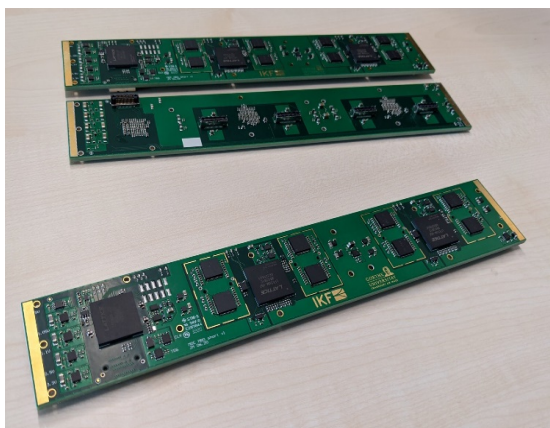
and equivalent X-ray irradiation. Operating with water vapor as gas additive turned out to be the stable solution and should also prevent further polymerization. During 2016-2018 JINR group together with GSI colleagues repaired sector 4 and installed it into the plane II of MWDC. This sector demonstrated good operation during data taking run in Spring 20219 (Ag+Ag reactions at  $T_{kin} = 1.55$  AGeV and 1.23 AGeV).

JINR team provided **30 MWDC expert shifts** during Spring 2019 data taking run.

In the end of data taking run in Spring 20219 sector 2 of MWDC-II was broken. JINR team during November 2019- February 2020 successfully repaired this sector, tested it with the standard gas mixture and high voltage setting. The repairing procedure of the Dubna MWDC-II sector at GSI is shown in figure 16.



**Figure 17:** One sector of HADES MWDC with new FEE based on the use of PASTTRECK chip.

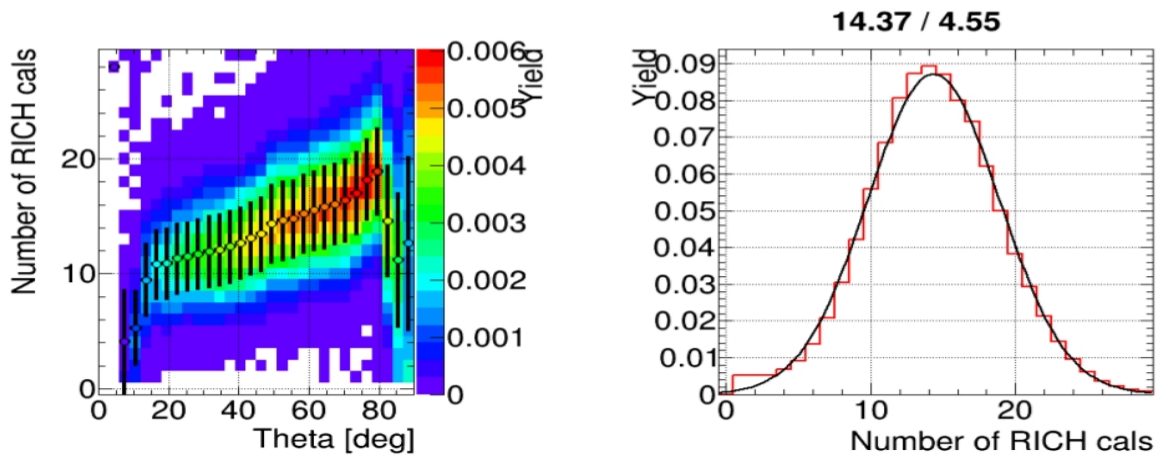


**Figure 18:** MWDC readout upgrade: new FEE (left) and new FEE based on PASTTRECK on the MWDC(right).

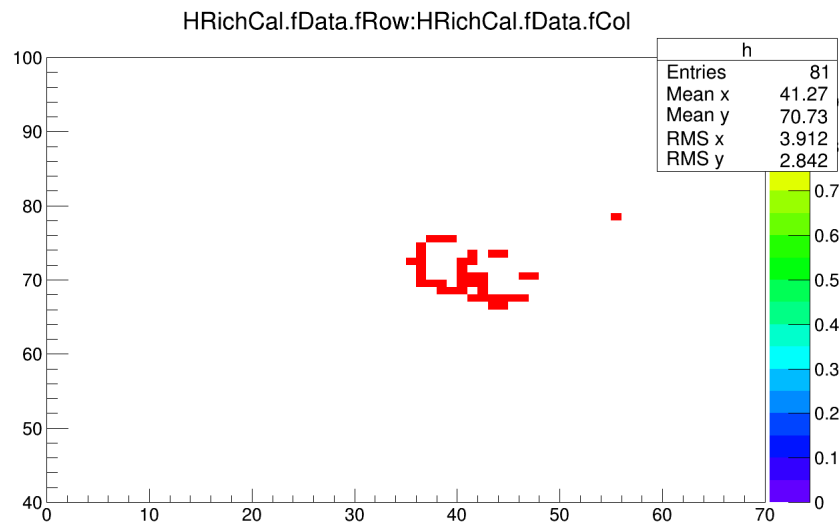
JINR team actively participates in MWDC readout upgrade using new FEE based on the use of PASTTRECK chip. The data transfer is also needed to be speed up using new TRB3

boards. The final goal is to reach the DAQ event rate for proton- proton collisions of 200 kHz. The first tests of FEE prototypes were started in the end of 2019 at GSI.

### JINR group software development in 2019-2021



**Figure 19:** Results of the cherenkov ring reconstruction in new RICH. Left panel represents the dependence of the number of the fired pixels in photodetectors as a function of the electron emission angle. The right panel show the distribution of the number of the MAPMT fired pixels per electron ring.

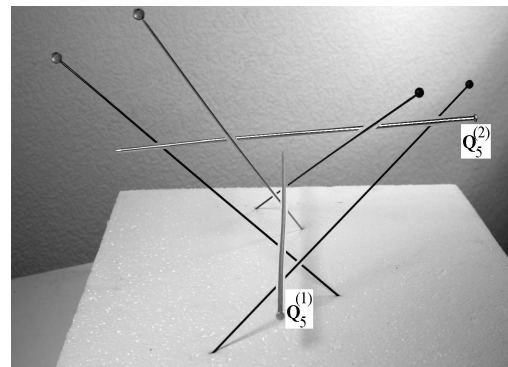
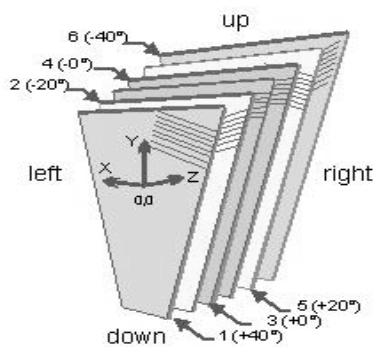


**Figure 20:** The cherenkov rings in new HADES RICH obtained for Ag+Ag collisions in 2019.

HADES and together with CBM collaboration constructed new RICH for the electron-positron pairs identification. The RICH detector uses 700 64-channel Hamamatsu H12700 Multi-

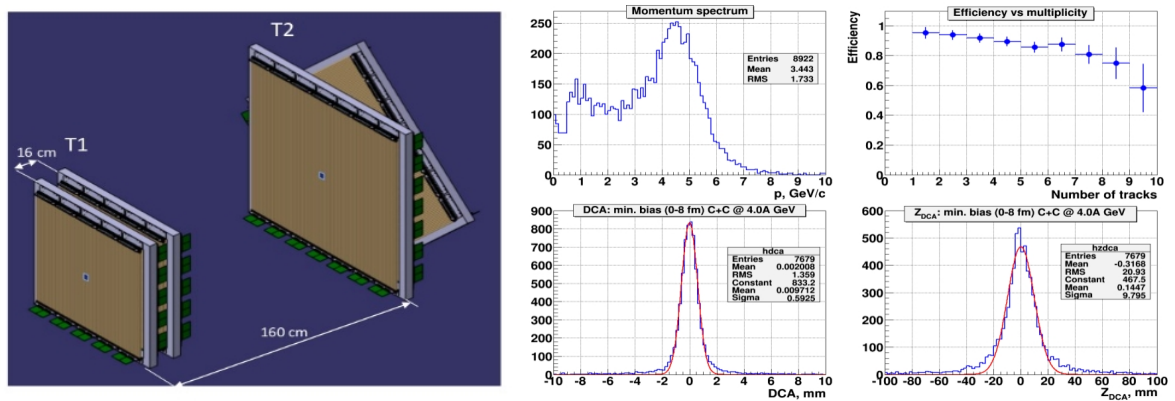
Anode PMTs (MAPMP). A complete set of digitizing electronics, consisting of analog and digital front-end modules, power supply and data concentrator cards plugged into a backplane carrying  $3 \times 2$  MAPMTs on the front side, and all readout modules on the backside was designed. In a joint effort the HADES RICH photon detector has been replaced by a subset of these MAPMTs together with a new FPGA-TDC based readout chain resulting in a significant improvement of  $e^+e^-$  pair reconstruction efficiency.

JINR contributes by the ring reconstruction algorithms based on the Hough transformation in new RICH. Results of the cherenkov ring reconstruction is shown in figure 19. Left panel represents the dependence of the number of the fired pixels in photodetectors as a function of the electron emission angle. The right panel show the distribution of the number of the MAPMTs fired pixels per electron ring. Upgraded RICH [32-34] has been used in the data taking campaign in 2019. The cherenkov rings in new HADES RICH obtained for Ag+Ag collisions in 2019 is shown in figure 20.



**Figure 21:** HADES MWDC tracking system (left) and demonstration of the track finder algorithm based on the solve of the G.Schubert problem for 4 straight lines (right).

JINR group continues to develop the track finder algorithm based on the solve of the G.Schubert problem for 4 straight lines (see figure 21). This new approach is very suitable for the wire (or strip) detectors, in particular, for HADES tracking system based on the MWDCs [35]. Freely distributed ROOT class for this tracking approach is under development.





**Figure 22:** Schematic view of the Forward Detector based on the PANDA straw tubes (left). The track reconstruction in HADES Forward Detector using algorithm based on the vector track finder approach C+C collisions at 4 AGeV (right).

New forward straw tracker is installed to increase HADES acceptance in the forward region ( $0.5^\circ$ - $7.0^\circ$ ) being important for hyperon production channels in pp collisions [28]. Also this forward tracker can be important for the event plane reconstruction in HIC. HADES Forward Detector consists of 4 stations schematically shown in the left panel in figure 22. JINR group develops the tracking algorithm based on the vector track finder approach [36]. The results of the track reconstruction for C+C collisions for 4 AGeV is shown in the right panel figure 22. The algorithm demonstrates quite high efficiency even for the relatively high track multiplicity, good primary and secondary vertices reconstruction.

JINR group continues to develop the kinematical refit for elementary reactions studied at HADES [37]. The work is in progress.

## **Publications, presentations at the conferences**

The main HADES results on physics obtained in 2019-2021 were published in 8 papers in regular journals [16-24]. 2 papers are accepted for publication in regular journals [27-28]. 4 technical papers on the RICH upgrade [32-34] and tracking [35] (1 with JINR principal authorship) have been published. 1 paper on di-electron production in pion-proton collision with JINR principal authorship has been published as an electronic preprint [29].

HADES results were reported at the international conferences [25-26], [30]. JINR peoples made 1 presentation at HADES collaboration meetings in 2019 [31].

## **Plans and request for 2022-2024**

The main direction of HADES activity in 2020-2024 is the data taking at SIS18 using proton, deuteron, pion and Au beams.

5 proposals on SIS18 beam time requests were submitted to GSI PAC in 2020:

1) Production and decay of hyperons, and inclusive hadron and dilepton production in p+p reaction at 4.5 GeV.

2) Searching for critical behavior and limitations of the universal freeze-out line (Au+Au collisions at 0.2A-0.8A GeV).

3) Studying medium effects in proton induced reactions (p+Ag reactions at 4.5 GeV).

4) Scrutinizing iso-spin effects in N+N bremsstrahlung and dibaryon  $d^*(2380)$  formation in N+P collisions.

5) Baryon coupling to mesons and virtual photons in the third resonance region: vacuum and cold matter studies (Pion induced reactions on CH<sub>2</sub>, C and Ag targets).

First proposal has been fully approved and supported by **80** 8hours shifts in 2022. Only **42** shifts were delivered for realization of the second proposal in 2022. HADES collaboration plans to resubmit to GSI PAC other proposals to obtain beam time in 2023-2024.

Therefore, the plans on the data taking in 2022 are fixed. JINR group will participate in the preparation and technical support during the beam time of the plane 2 of MWDCs, the software support during data taking and DST production.

JINR group is planning to take a part in the analysis of the p+p data at 4.5 GeV. The major goal is to study di-electron and hadronic observables. Also the JINR group is traditionally

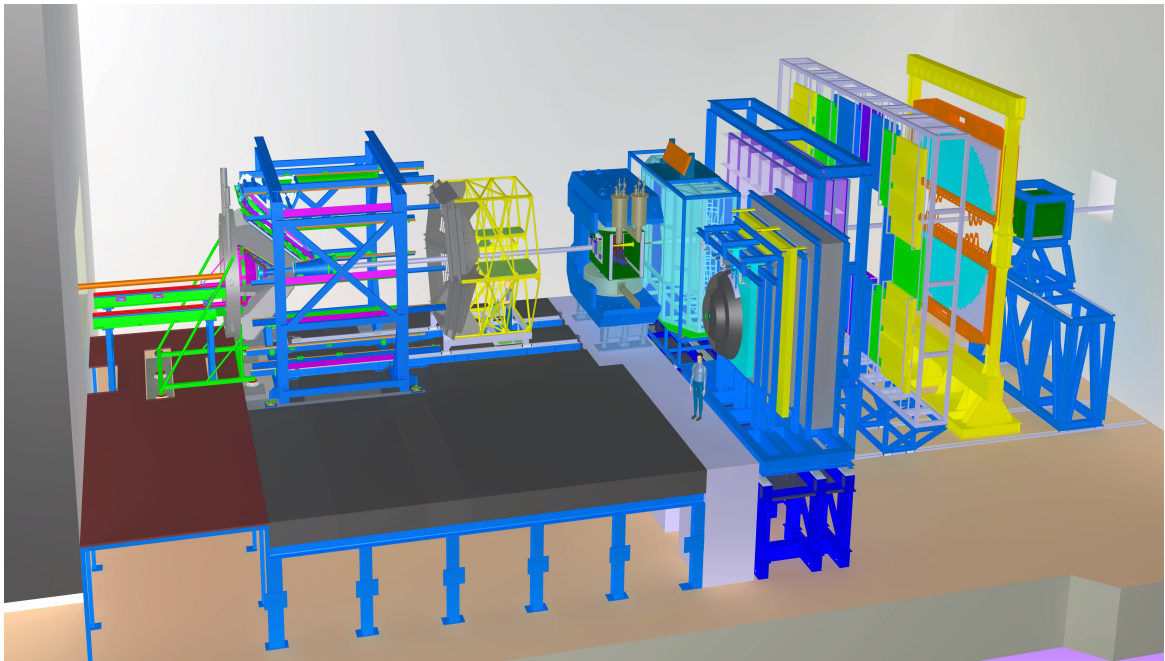
involved in the studies of the hadronic probes in elementary reactions. The physics includes multi-pion production in different reactions and their azimuthal correlations. Also the theoretical interpretation of HADES data will be continued.

The third direction is the JINR participation in HADES upgrade program and physics simulation for SIS100 at FAIR. JINR team is participating in MWDC upgrade including new FEE program and software development for tracking in MWDC and Forward Detector, RICH. JINR group is planning to make a second stand on the FEE for MWDC at VBLHEP.

JINR group is especially interested in pion- and deuteron- induced reaction. Hopefully, SIS18 beam time will be delivered in 2023-2024.

The activity of JINR group in HADES is performed within MoU (see Appendix A). HADES MoU is signed for 2018-2023 yy. Activity has been supported in 2020 yy. by BMBF-JINR grant 30 kEuro/year). The request for 2022-2024 yy. is about 25 kEuro/year within BMBF-JINR grant and JINR-Czech Republic program (see Appendix B). The human resources are presented in Appendix C.

### **Perspectives: HADES at SIS100 at FAIR**



**Figure 23:** The schematic view of HADES and CBM installed at one cave for the experiments at SIS100

The high-intensity heavy-ion beams of the future FAIR accelerators offer excellent possibilities to produce and to investigate baryonic matter at highest densities in the laboratory. The research program comprises the study of the structure and the equation-of-state of baryonic matter at densities comparable to the ones in the inner core of neutron stars. This includes the search for the phase boundary between hadronic and partonic matter, the critical endpoint, and the search for signatures for the onset of chiral symmetry restoration at high net-baryon densities. HADES at SIS100 will be a part of the Compressed Baryonic Matter experiment. SIS100 accelerators deliver proton beams up to an energy of 30 GeV which permits investigations of

elementary processes like charm production in an energy range where no data exist. Nuclear reactions in the energy range from 2 to 10 GeV/nucleon will be studied with an upgrade of the HADES spectrometer, which is currently being operated at the GSI SIS-8 accelerator. The HADES spectrometer will be placed upstream of the CBM setup in one cave (see figure 23).

The physics with HADES at SIS100 is widely discussed. Due to tracking system based on the use of MWDCs HADES can work only for the Ni+Ni collisions at 14 AGeV. Nowadays the modification of HADES is going on both for the data taking campaigns in 2017-2018 at SIS18 and for SIS100 in future. The JINR physicists are participating in the MWDC upgrade project, software development and in the preparation of the physics program for HADES/CBM at SIS100.

## **SWOT analysis for the project HADES:JINR participation**

### **Strengths:**

HADES physics program focuses on the high-statistics studies of the rare probes like di-leptons and strangeness, which provide the information on the early stage of the strong interaction in the energy range of 1-4.5 A GeV. The energy range is unique and cannot be covered by BES-II at STAR at the moment, and by MPD and CBM in future.

### **Weaknesses:**

Very high competition for the available SIS18 beam for HADES. Only 1 from 5 proposals obtained full support in 2022, the second one obtained 50% from the requested beam time.

### **Opportunities:**

Synergy between NICA and FAIR/GSI experiments. DAAD and BMBF-JINR grants for young researchers.

### **Threats:**

JINR obligations on the MWDC maintenance and upgrade requires the staying of JINR physicists at GSI, what is impossible in 2019-2020 due to COVID-19 pandemic impact. Project budget is formed from JINR-BMBF money mostly – they were not distributed in 2018-2019.

## **Summary**

JINR participants of the HADES project are working on maintenance of Multiwire Drift Chambers with associated FEE before and during beamtime. Significant work has been done to put into operation broken sector of MWDC-II in 2019-2020 yy.

Main activity on the HADES project in 2022 is the participation in data taking at SIS18 for p+p and Au+Au collisions; the participation in the data analysis, simulation and theoretical interpretation for different reaction channels in Ag+Ag, NN,  $\pi$ A and pA collisions at 1.25-3.5 A GeV.

JINR team is participating in the HADES upgrade and physics program for SIS100. HADES heavy ion program at SIS18 with Au-Au at 1.23 A GeV and Ag+Ag at 1.58 A GeV can have a serious impact on the physics program of BM@N, MPD and SPD as well.

Participation in the HADES project help us to build new infrastructure for detectors construction (DetLab in blg.40), where the new detectors for MPD/NICA are under development.

The «HADES:JINR participation» was supported by grant of BMBF/JINR in 2020 yy. New application for 2021 has been submitted.

## References

- [1] G.Agakishiev et al. (HADES Collaboration), “The High-Acceptance Dielectron Spectrometer HADES”, **Eur.Phys.J. A41 (2009) 243**.
- [2] O.V.Andreeva et al., “Forward scintillation hodoscope for nuclear fragment detection at the high acceptance dielectron spectrometer (HADES) setup”, **Instrum.Exp.Tech. 57 (2014) 103**.
- [3] H.Bokemeyer et al., “Development of low-mass drift chambers for the HADES spectrometer”, **Nucl.Instrum.Meth. A477 (2002) 397**.
- [4] C.Carabatos et al., “Optimisation of low mass drift chambers for HADES”, **Nucl.Instrum.Meth. A412 (1998) 38**.
- [5] L.N.Glonti et al., “Development and construction of a multilayer drift chamber prototype (MDC-2) for the HADES spectrometer”, JINR Preprint **JINR-P13-2000-80** (In Russian).
- [6] S.P.Chernenko et al., “Development and investigation of low-mass multilayer drift chambers (MDC-2) for inner part of the HADES spectrometer”, **JINR Rapid Commun. 5-6 (1999) 22** (In Russian).
- [7] E.Badura, Yu.V.Zanevsky and S.P.Chernenko, “Development and design of analog read-out electronics for HADES drift chamber system”, **Part.Nucl.Lett. 98 (2001) 73**.
- [8] G.N.Agakishiev et al., “Fast method for searching for tracks in multilayer drift chambers of HADES spectrometer”, **Part.Nucl.Lett. 101 (2000) 54**.
- [9] O.Pechenova et al., “The Alignment Strategy of HADES”, **Nucl.Instrum.Meth. A785 (2015) 40**.
- [10] G.Agakishiev et al. (HADES Collaboration),”Study of dielectron production in C+C collisions at 1-A-GeV”, **Phys.Lett. B663 (2008) 43**.
- [11] G.Agakishiev et al. (HADES Collaboration),”Dielectron production in C-12+C-12 collisions at 2-AGeV with HADES”, **Phys.Rev.Lett. 98 (2007) 052302**.
- [12] R.J.Porter et al. (DLS Collaboration),”Dielectron cross-section measurements in nucleus-nucleus reactions at 1 AGeV” **Phys. Rev. Lett. 79 (1997) 1229**.
- [13] W.K.Wilson et al. (DLS Collaboration),”Inclusive dielectron cross-sections in p+p and p+d interactions at beam energies from 1.04-GeV to 4.88-GeV”, **Phys.Rev. C57 (1998) 1865**.
- [14] G.Agakishiev et al. (HADES Collaboration),”Origin of the low-mass electron pair excess in light nucleus-nucleus collisions”, **Phys.Lett. B690 (2010) 118**.
- [15] G.Agakishiev et al. (HADES Collaboration), “Dielectron production in Ar+KCl collisions at 1.76A GeV”, **Phys.Rev. C84 (2011) 014902**.
- [16] J.Adamczewski-Musch et al. (HADES Collaboration), Probing dense baryon-rich matter with virtual photons, **Nature Phys. 15 (2019) 1040**.
- [17] J.Adamczewski-Musch et al. (HADES Collaboration), Charged-pion production in Au+Au collisions at  $\sqrt{s_{NN}}=2.4$  GeV, **Eur.Phys.J.A 56 (2020) 10, 259**.
- [18] J.Adamczewski-Musch et al. (HADES Collaboration), Identical pion intensity interferometry in central Au + Au collisions at 1.23 A GeV, **Phys.Lett. B795 (2019) 446**.
- [19] J.Adamczewski-Musch et al. (HADES Collaboration), Identical pion intensity interferometry at  $\sqrt{s_{NN}}=2.4$  GeV: HADES collaboration, **Eur.Phys.J.A 56 (2020) 5, 140**.
- [20] J.Adamczewski-Musch et al. (HADES Collaboration), Directed, elliptic and higher order flow harmonics of protons, deuterons and tritons in Au+Au collisions at  $\sqrt{s_{NN}}=2.4$  GeV, **Phys.Rev.Lett. 125 (2020) 262301**.
- [21] J.Adamczewski-Musch et al. (HADES Collaboration), Proton-number fluctuations in  $\sqrt{s_{NN}}=2.4$  GeV Au+Au collisions studied with the High-Acceptance DiElectron Spectrometer (HADES), **Phys.Rev.C 102 (2020) 2, 024914**.
- [22] J.Adamczewski-Musch et al. (HADES Collaboration), Sub-threshold production of K0s mesons and Lambda hyperons in Au+Au collisions at  $\sqrt{s_{NN}}=2.4$  GeV, **Phys.Lett. B793 (2019) 457**.

- [23] J.Adamczewski-Musch et al. (HADES Collaboration), Strong absorption of hadrons with hidden and open strangeness in nuclear matter, **Phys.Rev.Lett.** **123** (2019) **022002**.
- [24] J.Adamczewski-Musch et al. (HADES Collaboration), Two-Pion production in the second resonance region in  $\pi$ -p collisions with HADES, **Phys.Rev.C** **102** (2020) **2, 024001**.
- [25] B.Ramstein et al. (HADES Collaboration), Time-Like Baryon Transitions studies with HADES, In Proceedings of the 15-th International Workshop on Meson Physics (MESON 2018), 7-12 June 2018, Kraków, Poland, **EPJ Web Conf.** **199** (2019) **01008**.
- [26] P.Salabura et al. (HADES Collaboration), Exploring time like transitions in pp, $\pi$ p and AA reactions with HADES, In Proceedings of the 12th International Workshop on the Physics of Excited Nucleons (NSTAR 2019), June 10-14, 2019, Bonn, Germany, **EPJ Web Conf.** **241** (2020) **01013**.
- [27] J.Adamczewski-Musch et al. (HADES Collaboration), Correlated pion-proton pair emission off hot and dense QCD matter, e-Print: 2012.01351 [nucl-ex], to be published in **Phys.Lett. B**.
- [28] J.Adamczewski-Musch et al. (HADES and PANDA Collaborations), Production and electromagnetic decay of hyperons: a feasibility study with HADES as a Phase-0 experiment at FAIR, e-Print: 2010.06961 [nucl-ex], to be published in **Eur.Phys.J. A**.
- [29] A.P.Jerusalimov and G.I.Lykasov, Dielectron production in pion-nucleon reactions and form factor of baryon transition within the time-like region, E-print: **1907.10298**.
- [30] A.P.Jerusalimov et al., Study of multipion production in np-interaction at intermediate energies, In Proceedings of the XXIV-th International Baldin Seminar on High Energy Physics Problems "Relativistic Nuclear Physics and Quantum Chromodynamics", 17-22 September 2018, Dubna, Russian Federation, **EPJ Web Conf.** **204** (2019) **06006**.
- [31] G.Lykasov and A.Jerusalimov, Hadron and Dielectron Production in Pion-Nucleon Collisions, talk at the XXXV-th HADES Collaboration Meeting, 11-15 March 2019, GSI, Darmstadt, Germany.
- [32] J.Adamczewski-Musch et al. (TRB Collaboration), Efficiency and temporal response of p-terphenyl based wavelength shifting films on H12700 multi anode photomultipliers, **Nucl.Instrum.Meth. in Phys.Res.** **A952** (2020) **161867**.
- [33] J.Adamczewski-Musch et al. (TRB Collaboration), Status of the CBM and HADES RICH projects at FAIR, **Nucl.Instrum.Meth. in Phys.Res.** **A952** (2020) **161970**.
- [34] J. Förtsch et al., Fast readout and performance of the upgraded HADES RICH in heavy ion collisions, **JINST** **15** (2020) **C03021**.
- [35] A.V.Belyaev et al., On the initial approximation of charged particle tracks in detectors with linear sensing elements, **Nucl.Instrum.Meth. in Phys.Res.** **A938** (2019) **1**.
- [36] D.Zinchenko, A.Zinchenko, E.Nikonov, Vector Finder—A Toolkit for Track Finding in the MPD Experiment, **Phys.Part.Nucl.Lett.** **18** (2020) **107**.
- [37] A.V.Belyaev et al., Kinematical fit, JINR Communication **R1-2016-71** (2016) 21pp., JINR, Dubna (in Russian).

## Appendix A.

### MoU between GSI and JINR

#### Joint Institute for Nuclear Research (JINR), LHEP, Dubna

##### *Members of the group*

Vladimir Ladygin, Oleg Fateev, Alexander Ierusalimov, Alexander Belyaev, Alexander Malakhov, Alexander Troyan (perm.); Pavel Kurilkin, Alexei Kurilkin (PostDocs); Yaroslav Skhomenko (Student)

The institute will contribute to all types of experiments performed with HADES. The analysis activities will be focused on the baryonic resonance studies in hadronic and electromagnetic channels and short range correlations in proton/deuteron induced reactions. The institute will contribute in the R&D for MCD plane-II and for Forward Detector.

Participation in analysis activities	Resources
Detector maintenance and commissioning (MDC)	0.7x FTE
Physics analysis:	2.0x FTE
Common funds	1 k€/year
Detector upgrade	Resources
R&D for MDC and Forward Detector	12 k€/year (from JINR-BMBF grant)
HADES at SIS100	
Interest in pp and dp program : baryonic resonances studies, SRC	



Vladimir Ladygin  
Collaboration Board Member



Vladimir Kekelidze  
Director LHEP JINR

## Appendix B.

Cost estimation for HADES project (JINR participation)

NN	Name expenses	Total cost (kEuro)*	2022 y.	2023 y .	2024 y.
	Direct expenses for the project:				
1	Nuclotron, hours.				
3	Computer link				
4	Laboratory design division, hours				
5	JINR workshops, norm-hours				
6	Materials	21	7	7	7
7	Equipment	18	6	6	6
8	Travelling expenses	36	12	12	12
	a) in countries not ruble zone	36	12	12	12
	b) In the countries of the ruble zone				
	c) on protocols				
	Total direct expenses	75	25	25	25

\* from BMBF-JINR grant and JINR-Czech Republic Scientific Cooperation Program

**Appendix C.**  
Participants in HADES project from JINR (FTE)

<b>Laboratory</b>	<b>№№</b>	<b>Name, Surname</b>	<b>FTE</b>	<b>Duty</b>
<b>LHEP</b> <b>2.4 FTE</b>	<b>1</b>	<b>Belyaev A. V.</b>	<b>0.5</b>	<b>Software development: tracking and kin.refit</b>
	<b>2</b>	<b>Fateev O.V.</b>	<b>0.1</b>	<b>MWDC maitenance and upgrade, management</b>
	<b>3</b>	<b>Ierusalimov A.P.</b>	<b>1.0</b>	<b>Software developments in tracking and simulation</b>
	<b>4</b>	<b>Ladygin V.P.</b>	<b>0.1</b>	<b>Physics, management</b>
	<b>5</b>	<b>Reznikov S.G.</b>	<b>0.2</b>	<b>MWDC maitenance, FEE upgrade project</b>
	<b>6</b>	<b>Troyan A. Yu.</b>	<b>0.5</b>	<b>Computing, simulation</b>
	<b>7</b>	<b>Zinchenko A.I.</b>	<b>0.1</b>	<b>Software developments in tracking: vector finding algorithm</b>
<b>LIT</b> <b>0.6 FTE</b>	<b>8</b>	<b>Ivanov V.V.</b>	<b>0.1</b>	<b>Software developments for RICH</b>
	<b>9</b>	<b>Lebedev S.A.</b>	<b>0.5</b>	<b>Software developments for RICH, data taking</b>
<b>LNP</b> <b>0.1 FTE</b>	<b>10</b>	<b>Lykasov G.I.</b>	<b>0.1</b>	<b>Theoretical interpretation</b>