

Project NA61-SHINE

Study of Hadron Production in Hadron-Nucleus and Nucleus-Nucleus Collisions at the CERN SPS (SHINE – SPS Heavy Ion and Neutrino Experiment) (JINR participation)

CODE OF THEME: 02-1-1087-2009/2023

Theme: Research on Relativistic Heavy and Light Ion Physics.
Experiments at the Accelerator Complex Nuclotron/NICA at
JINR and CERN SPS

B. Baatar^a, V.A. Babkin^b, M. Bogomilov^c, M.G. Buryakov^b, A.V. Dmitriev^b,
S.Ileeva^c, D. Kolev^c, V.A. Kireyeu^b, V.I. Kolesnikov^b, R.Yu. Kolesnikov^b, V.V.
Lenivenko^b, G.I. Lykasov^d, V.V. Lyubushkin^d, A.I. Malakhov^b, V.A. Matveev^c,
G.L. Melkumov^b, B.A., Popov^d, M.M. Rumyantsev^b, V.V. Tereshchenko^d,
R. Tsenov^c, A.A. Zaitsev^b

a) Institute of Physics and Technology of Mongolian Academy of Science, Ulaanbaatar (Mongolia)

b) Veksler and Baldin Laboratory of High Energy Physics JINR (Dubna)

c) Sofia University "St. Kliment Ohridski" (Bulgaria)

d) Dzelepov Laboratory of Nuclear Problems, JINR (Dubna)

e) JINR management (Dubna)

NAME OF PROJECT LEADER

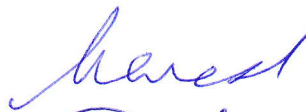

A.I. MALAKHOV

NAME OF PROJECT DEPUTY LEADERS



A.V. DMITRIEV



A.A. ZAITSEV

DATE OF PROPOSAL SUBMISSION TO SOD 24.03.2021

DATE OF THE LABORATORY STC 16.03.2021

DOCUMENT NUMBER: VBLHEP STC №1/2021



DATE OF PROJECT FIRST APPROVAL 2012

PROJECT ENDORSEMENT LIST

**Study of Hadron Production in Hadron-Nucleus and Nucleus-
Nucleus Collisions at the CERN SPS (SHINE – SPS Heavy Ion and
Neutrino Experiment)
NA61-SHINE**

CODE OF THEME: 02-1-1087-2009/2023

Theme: Research on Relativistic Heavy and Light Ion Physics.
Experiments at the Accelerator Complex Nuclotron/NICA at
JINR and CERN SPS

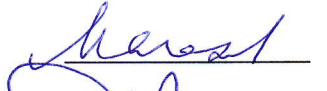
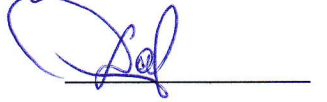
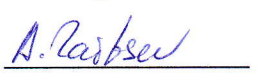
	SIGNATURE	DATE
APPROVED BY JINR DIRECTOR	_____	_____
ENDORSED BY:		
JINR VICE-DIRECTOR	_____	_____
CHIEF SCIENTIFIC SECRETARY	_____	_____
CHIEF ENGINEER	_____	_____
HEAD OF SCIENCE ORGANIZATION DEPARTMENT	_____	_____
LABORATORY DIRECTOR	 _____	<u>16.03.2021</u>
LABORATORY CHIEF ENGINEER	 _____	<u>16.03.2021,</u>
PROJECT LEADER	 _____	<u>03.03.2021</u>
PROJECT DEPUTY LEADERS	 _____	<u>03.03.2021</u>
	 _____	<u>03.03.2021</u>
APPROVED BY PAC FOR PARTICLE PHYSICS	_____	_____

Proposal for Extension
Participation of JINR in the NA61/SHINE
experiment at the CERN SPS
(theme 02-1-1087-2009/2023)

Spokesperson from CERN:

Marek Gazdzicki (marek.gazdzicki@cern.ch)

Leader from JINR:

Alexander Malakhov (malakhov@lhe.jinr.ru)

Deputy leaders from JINR:

Alexander Dmitriev (admitriev@jinr.ru)

Andrei Zaitsev(zaicev@jinr.ru)

Participants:

V.A. Matveev (*JINR management*);

V.A. Babkin, A. V. Dmitriev, M.G. Buryakov, V.A. Kireyeu, V.I. Kolesnikov,
R.Yu. Kolesnikov, V.V. Lenivenko, A.I. Malakhov, G.L. Melkumov,
M.M. Rumyantsev, A.A.Zaitsev
(*Veksler and Baldin Laboratory of High Energy Physics, JINR*);

G.I. Lykasov, V.V. Lyubushkin, B.A., Popov, V.V. Tereshchenko
(*Dzelepov Laboratory of Nuclear Problems, JINR*);

B. Baatar (*Institute of Physics and Technology of Mongolian Academy of Science, Ulaanbaatar, Mongolia*);

D. Kolev, M. Bogomilov, S. Ileeva, R. Tsenov (Sofia University "St. Kliment Ohridski", Bulgaria)

Contents

	Page
Form №24	1
Form №25	2
Title	3
Contents	4
Abstract	5
1. Introduction	6
2. Status of research	7
2.1 The subject of the research and methods	7
2.2 Set-up structure and updating	12
2.3 Expected results	15
2.4 Beam time schedule	16
2.5 Share of responsibility	17
2.6 Scientific experience of authors	17
2.7 Publications, PhD theses and presentations at conferences	17
3. Manpower resources	17
4. Estimation of project budget (Form No. 26), the expenses for 3 years	19
5. Estimation of expenditures (Form № 29)	20
6. Strengths, weaknesses, opportunities, threats	21
7. References	21
8. Appendix	
8.1 Prof. V. Burov referee report	23
8.2 Dr. A.A. Baldin referee report	25
8.3 Decision of the STC Laboratory	27

Abstract

This document has been prepared taking into account the recommendations of the 49th session of the JINR Program Advisory Committee (PAC) on Particle Physics and in accordance with the "Project Preparation Rules" available on the JINR website <http://www.jinr.ru/docs/>.

The NA61/SHINE experiment is included in the "JINR Seven-Year Development Plan" (http://www.jinr.ru/wp-content/uploads/JINR_Docs/7_plan_17-23_rus.pdf), where on page 19 it is written: "5. Obtaining new results in the energy scan program in the experiments NA61 (SPS) and STAR (RHIC) — 2017–2023"

It is proposed to continue studying the properties of hadron and nuclear fragmentation in processes with hadron and nuclear beams. The results of searching for a critical point in the phase diagram of nuclear matter by scanning the energy and atomic numbers of interacting nuclei are described in more detail.

Data analysis continues in the following areas

- the formation of light nuclei in nuclear interactions;
- hyperon generation in Be+Be, Ar+Sc, Xe+La, Pb+Pb interactions;
- antimatter production in the nucleus-nuclear interactions.
- charm particles production in relativistic heavy ion collisions.

Joint simulation work is underway for the NICA and NA61 projects, based on the experimental data obtained in the NA61 experiment.

A number of young employees are developing a new time-of-flight system based on Multigap Resistive Plate Chambers (MRPC). These detectors were developed for the NICA project. Therefore, it is now a great opportunity of testing them under real conditions of the NA61 experiment before the use of the NICA complex. Working with real beams on the NA61 setup will be a good test for these detectors. The detectors for one wall have been manufactured, and the electronics and gas system are being under construction. It is planned to start working with this system on CERN beams in the fall of 2021.

The need to use the experience of the NA61 experiment for the NICA project at JINR was taken into account. The extended project continues to optimize the number of employees participating in the experiment. Taking into account the implementation of the NICA project, the NA61 continues to optimize the number of employees participating in the experiment.

Experienced personnel who have defended their doctoral and PhD theses based on the results of the NA61 experiment are currently successfully working on the NICA project. Young JINR employees gain invaluable experience to implement the NICA project by participating in runs, detector developments, and data analysis on nuclear beams at CERN. An agreement was reached with the NA61 collaboration leader to organize training for young employees at the NA61 set-up, which is extremely useful for the NICA project. Dissertations are planned to be defended. Thus, the NA61 experiment is a good "forge" of personnel for the NICA project.

It should be noted that the participation of JINR in the experiment does not require large financial and human resources. At the same time, JINR employees participate in obtaining physical results of the highest world level and receive unique experience of working at the most modern level of science.

Employees of the Laboratory of High-Energy Physics study the nuclear-nuclear interactions and work at a new time-of-flight system based on MRPC. This activity requires relatively small resources. Employees of the Laboratory of Nuclear Problems participate in the neutrino program. This work does not require large financial resources either.

1. Introduction.

The NA61/SHINE strong interactions program is based on beam momentum scans (13A-158A-GeV/c) with light and intermediate mass nuclei (from p+p to Xe+La). The main physics goals include: 1) Search for the second-order critical end-point in the temperature versus baryon-chemical potential phase diagram (looking for non-monotonic behavior of critical point signatures, such as transverse momentum and multiplicity fluctuations, intermittency signal, etc., when system freezes out close to the critical point); 2) Study of the properties of the onset of deconfinement (search for the onset of the horn, kink, step, and dale structures in collisions of light nuclei).

In recent years, the program has been extended by Pb+Pb collisions where the open charm production, as well as collective effects are studied. Based on the obtained results, few years ago NA61/SHINE introduced a concept of two onsets in nucleus-nucleus collisions at the CERN SPS energies: onset of deconfinement (beginning of QGP formation – collision energy threshold for deconfinement) and onset of fireball (beginning of formation of a large cluster which decays statistically).

Dubna group principal activity in the following issues:

1. The study of light nuclei production. It is important for several reasons:

First of all, the mechanism of cluster formation in nucleus-nucleus collisions has not been well understood and requires further investigations. On the other side, deuterons and tritons, for example, are not elementary hadronic particles and because of their small binding energy compared to freeze-out temperatures, it is very probable that they will not survive in the repeated collisions. So, it is likely that the observed deuterons and tritons, as well as the significant fraction of few-nucleon bound states registered near the midrapidity range, are produced in the late stage of the reaction close to the freeze-out point. Thus, the light nuclei, observed in the experiment and formed near the freeze-out, may provide information on the space-time structure of this late stage of the collision.

2. The study of hyperon and hyper nuclei production in Ar+Sc, Xe+La, Pb+Pb interactions. Relativistic heavy ion collisions provide a unique opportunity of forming and investigating hot and dense matter. The QGP is formed at the initial stage of the reaction while the final stage is driven by the hadronization process and formation of clusters. The capture of the produced hyperons by clusters of nucleons leads to the hypernuclei formation which is a very rare process at strangeness threshold energies. Hypernuclei are unique in their potential of improving our knowledge on the strange particle-nucleus interactions

in a many body environment and under the controlled conditions. In its turn, this is essential to derive eventually a more general and self-consistent description of the baryon-baryon interaction.

3. The study of the release of anti-matter in relativistic nuclear interactions.

4. Analysis of experimental data using the Dubna approach. The development of the approach to study relativistic nuclear interactions in the space of four-dimensional velocities, proposed by Academician A. M. Baldin.

5. To measure the mean number of charm–anti-charm quark pairs $\langle c\bar{c} \rangle$ produced in the full phase space of heavy ion collisions. The feature of charm particle production in heavy ion collisions can be a signature about quark-gluon plasma formation, in particular, the suppression of the J/ψ -mesons yield. Such data do not exist yet and NA61/SHINE aims to provide them within the coming years.

6. The development of the time-of-flight detector based on Multigap Resistive Plate Chambers (MRPC) with high time-of-flight resolution. Joint development of detectors for

NA61 and NICA is underway. CERN nuclear beams are used for testing and debugging detectors.

7. The Laboratory of Nuclear Problems participates in the neutrino program of NA61.The NA61/SHINE collaboration has a program of hadron production measurements for long-baseline neutrino oscillation experiments at FNAL and J-PARC. These measurements improve the knowledge of the neutrino flux produced in accelerator based neutrino beams.

2. Status of research

2.1. The subject of the research and methods

In 2019-2021, the NA61/SHINE experimental data were processed and analyzed, and the installation was upgraded. Below are the most important latest results published during this period of time.

NA61/SHINE results on the collision energy dependence of the K^+/π^+ ratio and the inverse slope parameter of kaon m_T spectra in inelastic p+p interactions were published in [1]. These results were compared with the corresponding world data on p+p interactions as well as central Pb+Pb and Au+Au collisions. The comparison has shown a similarity between the collision energy dependence in p+p interactions and central heavy ion collisions in the same energy range. Understanding of the origin for the similarity between the results on heavy ion collisions and p+p interactions is one of the key objectives of heavy ion physics today.

The NA61/SHINE experiment at the CERN SPS studies the onset of deconfinement in hadron matter by a scan of particle production in collisions of nuclei with various sizes at a set of energies covering the SPS energy range. Paper [2] presents the results on inclusive double-differential spectra, transverse momentum and rapidity distributions and mean multiplicities of π^\pm , K^\pm , p and anti-p produced in the 20% most central ${}^7\text{Be}+{}^9\text{Be}$ collisions at beam momenta of 19A, 30A, 40A, 75A and 150A GeV/c. The energy dependence of the K^\pm/π^\pm ratios as well as of inverse slope parameters of the K^\pm transverse mass distributions are close to those found in inelastic p+p reactions. The new results are compared to the world data on p+p and Pb+Pb collisions as well as to predictions of the EPOS, UrQMD, AMPT, PHSD and SMASH models.

Our employees have made a great contribution to this work. In particular, a number of parameters were simulated using the PHSD (Parton-Hadron-String Dynamic) model. Some simulation results, for example, are shown in Fig. 1.

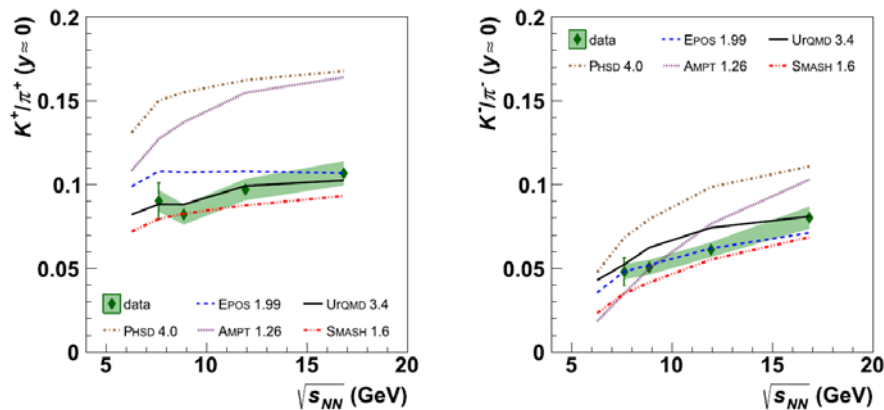

Fig.1. Comparison of the energy dependence of K^+/π^+ (left) and K/π^- (right) yields ratio at mid-rapidity for the 20% most *central* Be+Be collisions with models: EPOS 1.99 (blue dashed line), UrQMD 3.4 (black solid line), AMPT 1.26 (violet dotted line), PHSD (brown dashed-dotted line) and SMASH 1.6 (red dashed-double dotted line).

In the NA61 program the data have been also recorded from Ar+Sc, Xe+La and Pb+Pb collisions for which the analysis is ongoing. Results on central ${}^7\text{Be}+{}^9\text{Be}$ collisions were found to be similar to those from inelastic p+p interactions for shapes of transverse momentum and rapidity spectra as well as the K^+/π^+ ratios. However, the particle yields are higher by approximately a factor of four consistent with expectations from the wounded nucleon model. Summarizing, neither measurements nor models have shown any indications of a horn structure at low SPS energy for small collision systems in contrast to the results from central Pb+Pb interactions. The results were compared with predictions of the models: EPOS 1.99, UrQMD 3.4, AMPT 1.26, PHSD 4.0 and SMASH 1.6. None of the models reproduces all features of the presented results.

For a better understanding of the existing NA49 and future NA61 light nuclei data a model independent cluster finding library was developed [3] and presented to the Collaboration by V.Kireyeu. Phase-space Minimum Spanning Tree (psMST) is an open-source C++ library licensed under GNU GPLv3 which can be applied to any transport model: PHSD, PHQMD, SMASH, UrQMD and others. The psMST algorithm is based on the well known ideas of the Minimum Spanning Tree procedure. This can shed light on the origin and dynamics of the cluster production as well as the heavy ion collision evolution. Fig.2 shows deuteron rapidity distribution in Pb+Pb collisions at $P_{\text{lab}} = 40\text{A GeV/c}$. NA49 experimental data are taken from Phys. Rev. C 94, 044906 (2016).

The clusters found by psMST have agreed well with the experimental data. Fig.3 shows rapidity distributions of “A=2” clusters at 3 time steps: 40, 90, 150 fm/c at collision energy beam momentum 158A GeV/c. The psMST algorithm was applied to 3 different models: PHQMD, SMASH UrQMD. All transport approaches have given very similar results.

It is very important to have a robust modeling of the cluster formation, as its inclusion can modify single particle spectra, too, which is crucial for event-by-event fluctuation analysis, flow measurements and so on. The psMST can be also used at the NICA experiments. The paper with a detailed description of the algorithm and its performance with different models is under preparation now.

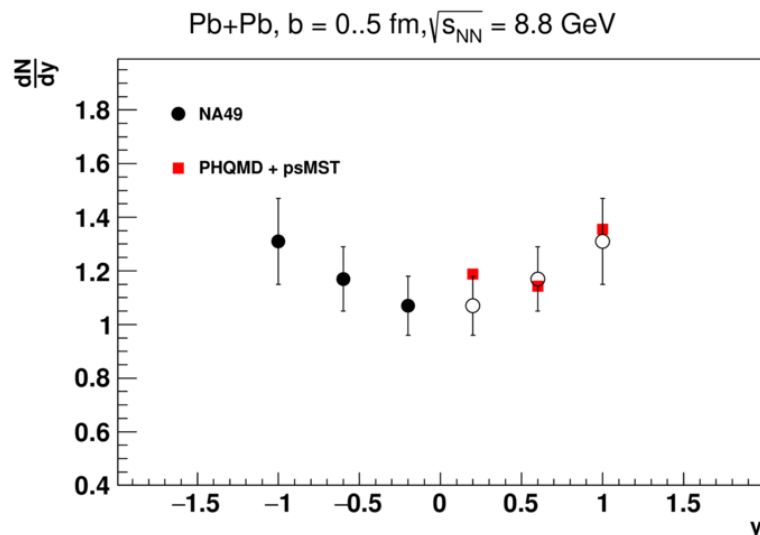

Fig.2. Rapidity spectra of deuterons measured in central Pb+Pb interactions at 40 GeV/c. Experimental data are shown with black circles, PHQMD + psMST predictions with red squares.

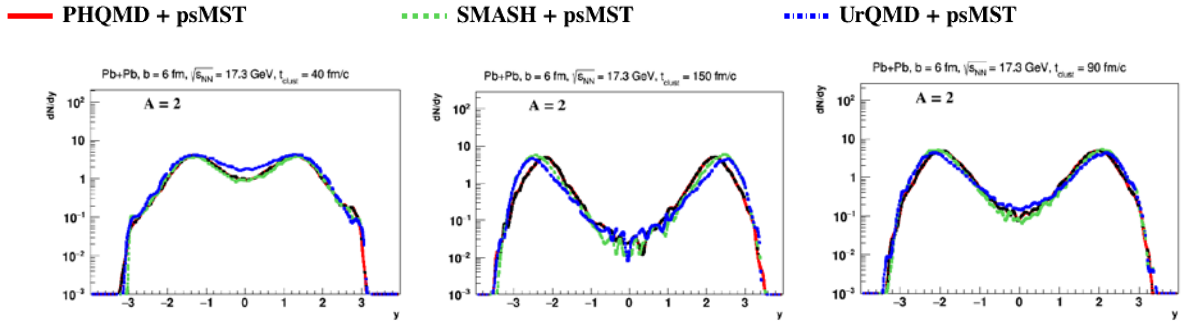

Fig.3. Rapidity spectra of light clusters with masses $A=2$ measured in central Pb+Pb interactions at 158 GeV/c. The psMST algorithm was applied to three models: PHQMD - red lines, SMASH - green dashed lines, UrQMD - blue dotted-dashed lines.

The production of $\Xi(1321)^-$ and anti- $\Xi(1321)^+$ hyperons in inelastic p+p interactions is studied in a fixed target experiment at a beam momentum of 158 GeV/c [4]. Double differential distributions in rapidity y and transverse momentum p_T have been obtained from a sample of 33M inelastic events. They have allowed one to extrapolate the spectra to full phase space and to determine the mean multiplicity of both Ξ^- and anti- Ξ^+ . The rapidity and transverse momentum spectra are compared to transport model predictions. The Ξ^- mean multiplicity in inelastic p+p interactions at 158 GeV/c is used to quantify the strangeness enhancement in A+A collisions at the same beam momentum. Some results of the simulation by the physicists of the Dubna group are shown in Fig.4.

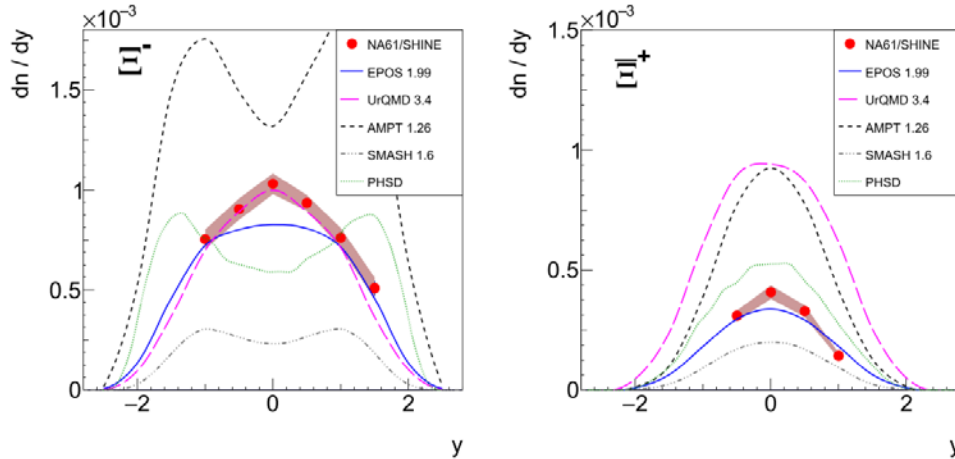

Fig.4. Rapidity spectra of Ξ^- (left) and anti- Ξ^+ (right) measured in inelastic p+p interactions at 158 GeV/c. Shaded bands show systematic uncertainties. Urqmd 3.4, Epos 1.99, Ampt 1.26, Smash 1.6 and Phsd predictions are shown as magenta, blue, black, gray and green lines, respectively.

One of the established goals of NA61/SHINE is the search for the critical point (CP) of strongly interacting matter. NA61/SHINE is the first experiment to perform a two-dimensional scan in the beam momentum ($13A - 150A$ GeV/c) and system size (p+p, p+Pb, Be+Be, Ar+Sc, Xe+La) of colliding nuclei, thus probing different freeze-out conditions in temperature T and baryochemical potential μ_B (Fig.5 left).

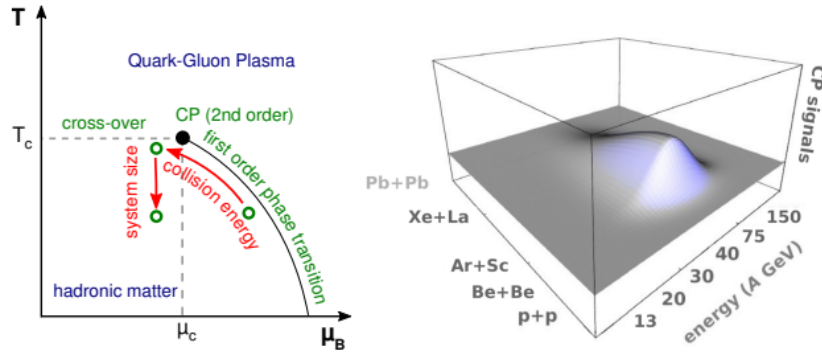

Fig.5. Left: Hypothetical sketch of the phase diagram of strongly interacting matter with critical point, drawn as a function of baryochemical potential μ_B and temperature T . Right: Theoretical studies predict the presence of a “hill of fluctuations” as a function of the colliding system size and energy for observables sensitive to the CP.

Near the CP, a second order phase transition occurs; the correlation length of the system diverges, leading to a scale-invariant system and an expected “hill” of increased fluctuations in various observables in the CP vicinity (Fig.5 right). At the CP, the fluctuations of the order parameter can be detected in the transverse momentum space within the framework of a proton intermittency analysis by means of scaled factorial moments (SSFMs). The SSFMs are calculated by partitioning a region of transverse momentum space into a lattice of $M \times M$ equal-size bins, and counting the number of proton pairs per bin.

According to the program on the search for a critical point in nuclear matter, new results from the proton intermittency analysis of inelastic $^{40}\text{Ar}+^{45}\text{Sc}$ collisions at $150\text{A}\cdot\text{GeV}/c$ have been reached as preliminary and reported in the Proceedings of the 45th Congress of Polish Physicists [5]. Selected proton purity was 90% or higher. The Second Scaled Factorial Moments (SSFMs) for selected protons (original and mixed events) were calculated. Results for the correlator $\Delta F_2(M)$ for the 10% and 20% centrality intervals are shown in Fig.6.

Original sample data values and their bootstrap standard errors are plotted against confidence intervals (68–95–99.7%) of the $\Delta F_2(M)$ distributions obtained from 1000 bootstrap resamplings of the analyzed events. Fig.6 (top right) compares the experimental $\Delta F_2(M)$ values against the $\Delta F_2(M)$ obtained from uncorrelated proton background with the same inclusive characteristics as the original $^{40}\text{Ar}+^{45}\text{Sc}$ events. Based on the observed $\Delta F_2(M)$ confidence intervals for the 10–20% most central set, one can conclude that SSFMs differ from zero by about $\sim 1 - 2\sigma$, indicating a borderline statistically significant separation of real data from mixed events (background). The same conclusion is drawn by comparison to random background, Fig. 6 (bottom right).

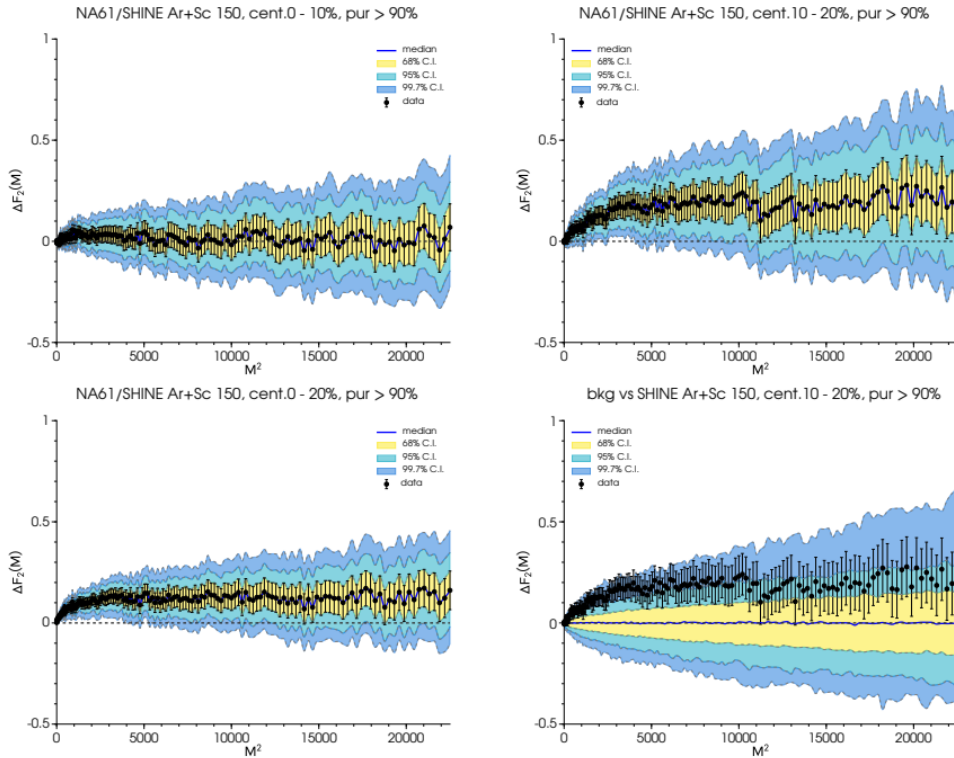

Fig.6. The correlator $\Delta F_2(M)$ for $^{40}\text{Ar}+^{45}\text{Sc}$ 0–10% (top left), 10–20% (top right), and 0–20% (bottom left) most central collisions at 150A-GeV/c (black points); error bars correspond to bootstrap standard error; colored bands indicate bootstrap confidence intervals; solid blue line gives the median value of bootstrap samples. Bottom right: 10–20% most central $\Delta F_2(M)$ (black points) compared to $\Delta F_2(M)$ of simulated random background protons, for the same event statistics.

Unfortunately, reliable confidence intervals for the intermittency index could not be obtained through simple power-law fits due to the values for different bin sizes M being correlated. Therefore, intermittency status is currently inconclusive for $^{40}\text{Ar}+^{45}\text{Sc}$ collisions at 150A-GeV/c. The quality and uncertainties of $\Delta F_2(M)$ power-law scaling remain still to be established. The analysis is ongoing.

Physicists from JINR have also fulfilled original investigations using the approach to study relativistic nuclear interactions in the four-dimensional velocity space, this approach was developed earlier by A.M.Baldin. The principles of similarity and automodelity turned out to be very fruitful in studying nuclear interactions at high energy.

In particular, using the similarity principle the physicists for the first time have obtained the analytic description of pion rapidity distributions while interacting with relativistic nuclei, which excellently describe the NA61/SHINE data registered at all projectile momenta in the range from 20 GeV/c to 158 GeV/c [6]. These results are given in Fig.7 (left). Fig.7 (right) shows the results of our calculations of pion spectra on the transverse mass m_{tr} in the PbPb, ArSc, BeBe and pp collisions in the central rapidity region at $\sqrt{s} = 8.77$ GeV (or at the projectile momentum per nucleon $P_{\text{in}} = 40$ GeV/c) in comparison with the data from experiment NA61/SHINE [7].

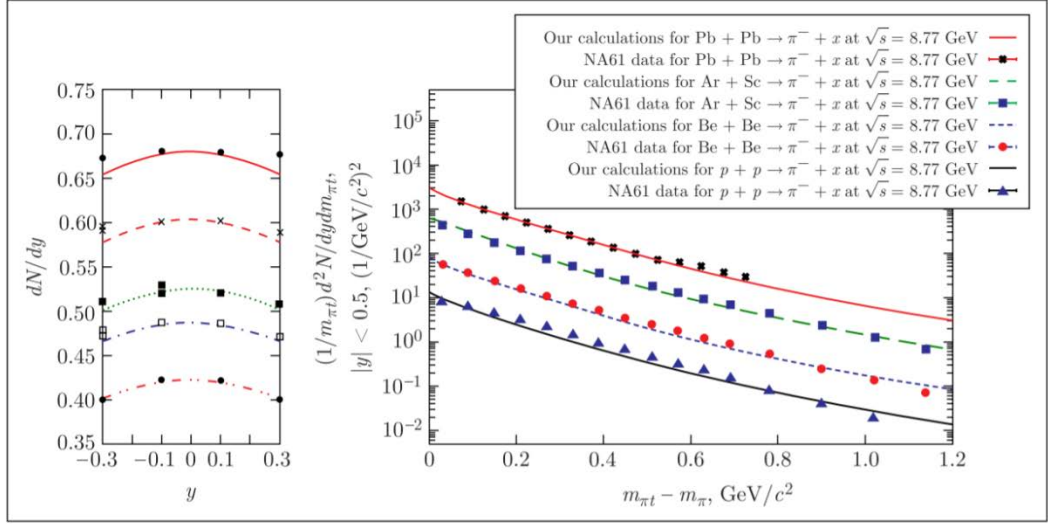

Fig. 7. Left: rapidity pion distributions (y) in $p + p$ collisions at projectile momenta $P_{in} = 158$ GeV/c (solid red curve), 80 GeV/c (dashed red curve), 40 GeV/c (green curve), 31 GeV/c (blue curve), 20 GeV/c (red lower curve) in comparison with NA61/SHINE experiment in the process $p + p \rightarrow \pi^- + x$ [5]. Right: the results of our calculations of spectra $m_{\pi\pi}$ in Pb + Pb, Ar + Sc, Be + Be and $p + p$ collisions in the central rapidity region at the projectile momentum per nucleon $P_{in} = 40$ GeV/c in comparison with the data of NA61/SHINE experiment [6]

In addition to the above-mentioned results, many others were obtained, in particular:

- search for pentaquarks in $p+p$ at 158 GeV/c [8];
- ϕ meson production in $p+p$ at 40–158 GeV/c [9];
- $K^*(892)$ production in $p+p$ at 158 GeV/c [10];
- two-particle correlations in azimuthal angle and pseudorapidity in Be+Be [11].

Recently, the data analysis on interactions of Ar + Sc nuclei with beam momenta: 13A, 19A, 30A, 40A, 75A, and 150A GeV/c has been started. Now, A. Zaitsev is carrying out a procedure to identify the produced particles π^\pm , K^\pm , and (anti)protons at mid-rapidity region for the most central collisions of Ar + Sc.

The NA61/SHINE collaboration has a program of hadron production measurements for long-baseline neutrino oscillation experiments at FNAL and J-PARC. These measurements improve knowledge of the neutrino flux produced in accelerator based neutrino beams. NA61/SHINE measures total cross sections and differential spectra of hadron yields from thin and replica neutrino beam targets. Furthermore, the collaboration performs hadron production measurements relevant to interpret the air-shower data at ultrahigh energies and measures fragmentation cross sections to understand Galactic cosmic ray data [12, 13].

2.2 Set-up structure and updating

During the Long Shutdown 2 at CERN (2019-2021), a significant modification of the NA61/SHINE spectrometer has been going. The upgrade is motivated by the charm and neutrino programs which require a tenfold increase of the data-taking rate to about 1 kHz. The charm program also requires doubling of the phase-space coverage of the Vertex Detector. This, in particular, requires the following: (i) construction of a new Vertex Detector, (ii) replacement of the TPC readout electronics, (iii) implementation of new trigger and data acquisition systems, (iv) upgrade of the Projectile Spectator Detector, (v) construction of new ToF detectors for particle identification at mid-rapidity.

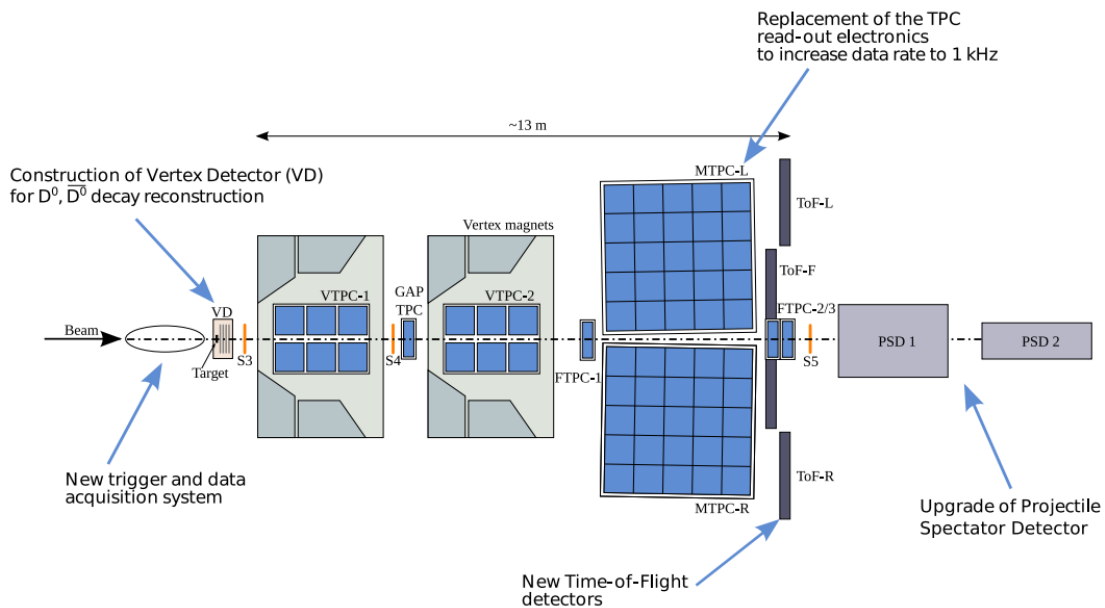

Fig.8. Upgrades of NA61/SHINE planned to be completed during the LS2 period.

The detector upgrades are graphically summarized in Fig.8 and discussed in detail in [14–16].

A group of employees (A.Dmitriev et al.) from JINR is responsible for upgrading the Time of Flight system (ToF) of the set-up. The previous time of flight system for particle identification consisted of two walls having 891 scintillation detectors each. One of the walls was made at JINR. The time resolution on the average was 75 ps that provided to separate kaons from pions till the momentum 8 GeV/c. After 20 years of work most of the parts of the system required a significant reconstruction. In this connection there was a decision to substitute the old system for the new ToF system based on BM@N type Multi-gap Resistive Plate Chambers (MRPC). It became possible due to the JINR Directorate grant [17]. These activities are going well now. The production of the detectors for a single wall has been completed. A new approach to amplify and digitize the MRPC's signals will be used in the readout electronics. Less than 10-ps Analogue Frontend Electronics (AFE) for the MRPCs have been developed. The output signals of the AFE are digitized by a 32-channel high-speed Digitization Board (DB). The DB production is carried out by Geneva University with JINR group. Test results of the AFE have indicated that the readout electronics operates well, and its time resolution is better than the frontend amplifier/discriminator on the base of the widespread NINO ASIC in the dynamic range of 50-1200 fC (see Fig. 9). The detectors in a full configuration have been tested and showed an excellent time resolution on the CERN and FIAN beams. The gas system construction is underway at CERN. This work is extremely useful for the NICA project since the time-of-flight detectors as well as the new type of the frontend electronics are planned to be used in the MPD installation at NICA.

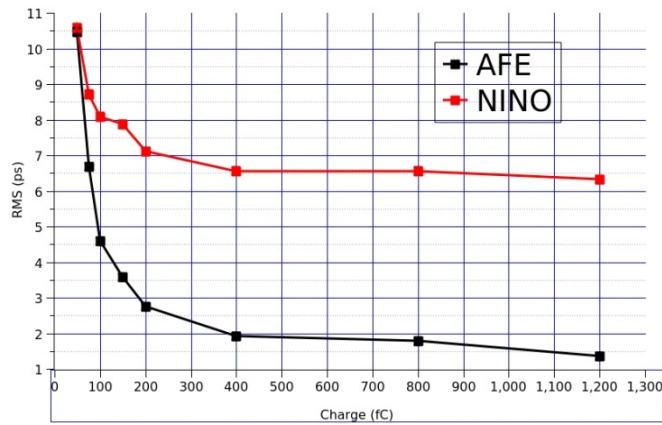

Fig.9. Time resolution dependence on the signal charge.

Two types of MRPCs have been considered as individual detectors for the NA61\SHINE ToF wall to guarantee the required low detector occupancy: the "narrow" detector (with the 150 mm strip signal readout) and the "wide" one (with 300 mm strip readout). The "wide" MRPC is absolutely identical to the detectors used in BM@N experiment. The both options have similar traits in terms of assembling and operation. The counters have fully differential, symmetric, triple-stack architecture, the signals being readout at both strip sides. A scheme of the MRPC detector is presented in Fig. 10.

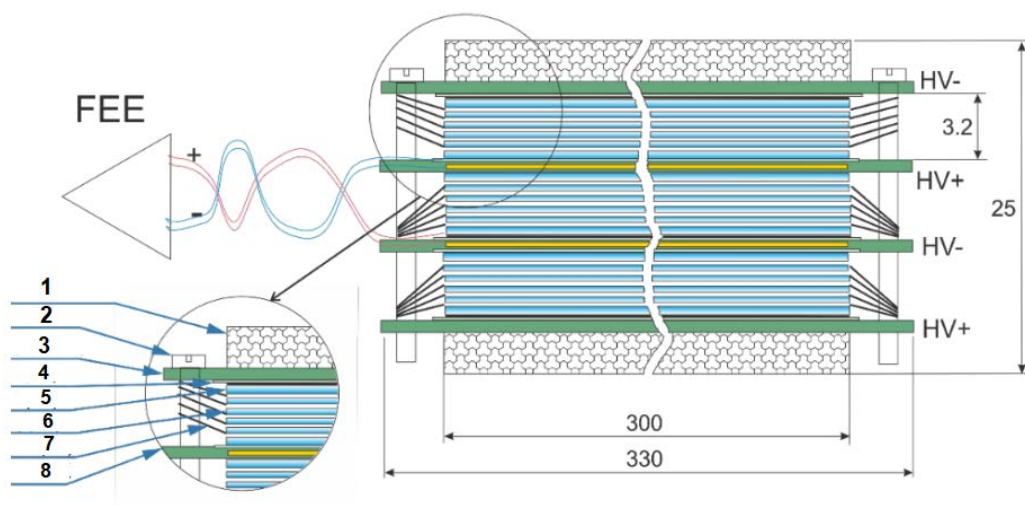

Fig.10. Scheme of a triple-stack MRPC with read-out strips: 1- honeycomb (5 mm); 2- PET screw; 3- outer PCB (1,5 mm); 4- mylar (100 μm); 5- outer HV glass (400 μm); 6- inner glass (280 μm); 7- spacer (fishing line 200 μm); 8- PCB with strips (1,5 μm).

The latest beam test was carried out at accelerator S-25R "PAKHRA" at LPI RAS in Troizsk at the end of 2020. The positron beam in the perpendicular direction to the chamber was provided with energy of 300 MeV/c. A schematic of the experimental setup is given in Fig. 11a.

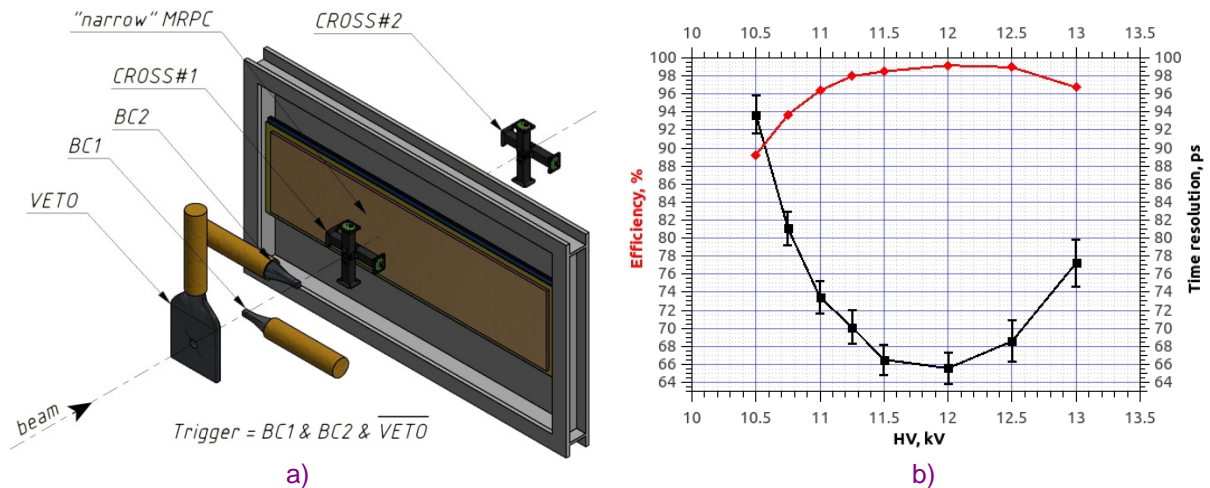

Fig.11. a) A schematic view of the beam test of MRPC at S-25R “PAKHRA” b) Time resolution and efficiency of the MRPC.

The performance of the proposed MRPC is illustrated in Fig. 11b. The best time resolution was 65.7 ± 1.7 ps achieved at 12kV and 99% efficiency. The drop of the efficiency at the high voltage is due to the presence of streamers. The signal analysis software was configured on single-avalanche regime. The future analysis software will require the detailed waveform studies and algorithm modification to handle all types of the MRPC signals.

The construction of a new NA61/SHINE time of flight system will consist of two symmetrical modules – gas resistive bodies which will be located on the supports used for the previous system. The typical gas mixture for the MRPC detectors will consist of 90% freon R134a, 5% isobutane and 5% SF₆. The gas mixture must be transported to each module independently on the specialized system recycling this mixture.

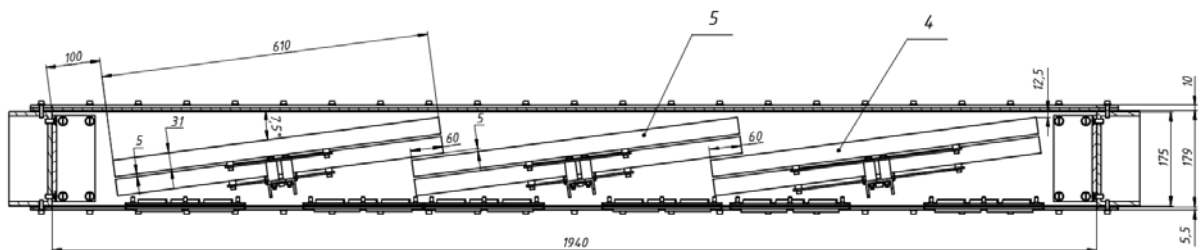

Fig.12. View from above at the Time of Flight module in the cut.

The MRPC detectors are located inside the modules at the angle of 7.5° relatively the forward plane as it is shown in Fig.12. The location of the detectors inside the modules has been developed taking into account minimization of the sensitive area losses.

During 2021-2022 it is planned to complete manufacturing the new Time of Flight system for experiment NA61/SHINE.

2.3. Expected results

Extensive statistics already collected at various energies and a wide range of colliding nuclei have enabled us to obtain a large number of planned physical results. The Dubna Group traditionally participates in obtaining data on the following tasks:

- formation of light nuclei in nuclear interactions

(This task is the full responsibility of the Dubna group. V. Kolesnikov defended his doctoral dissertation on deuteron formation in nuclear interactions. The work is continued to study the formation of heavier nuclei);

- hyperon generation in Be+Be, Ar+Sc, Xe+La, Pb+Pb interactions (Identification and reconstruction of Λ -hyperon spectra in Ar+Sc and Xe+La collisions at 30A and 150A·GeV as the first step to study the hypernuclei formation);
- antimatter production in the nucleus-nuclear interactions;
- open and hidden charm production in heavy ion interaction;
- neutrino program (The Laboratory of Nuclear Problems);
- The development of a new time-of-flight system based on MRPC (second wall) will be completed.

Being responsible for data taking with the time-of-flight detector and identification of the secondary particles, the Dubna group actively contribute to the search for the critical point and onset of fireball phenomena in the strong interaction matter.

Reports at the international meetings, conferences and publication of scientific articles are foreseen.

It is planned to prepare two PhD theses and doctor dissertation using the results obtained in the NA61 experiment and the NICA project.

The results obtained by NA61/SHINE and overall progress in physics on strong interactions, neutrinos and cosmic-rays have indicated the necessity to extend NA61/SHINE measurements beyond the ones planned for the period of 2021-2024. New measurements should be carried out after the Long Shutdown 3. Physics motivation and required beams are briefly summarized in [18].

2.4. Beam time schedule

The request for measurements in 2022-2024 was presented in detail in 2018 Addendum [19]. The SPSC recognized the broad interest of the NA61/SHINE physics program after LS2 [20, 21], as outlined in the 2018 Addendum. The measurements requested for 2022-2024 will continue the measurements approved for 2021 and they are listed below.

Physics with lead beams:

- (i) **2022**: four weeks of Pb beam at 150A GeV/c for charm hadron measurements in Pb+Pb collisions,
- (ii) **2022**: two weeks of a secondary light-ion beam at 13A GeV/c for nuclear fragmentation cross-section measurements for cosmic-ray physics,
- (iii) **2023**: six weeks of Pb beam at 150A GeV/c for charm hadron measurements in Pb+Pb collisions,
- (iv) **2024**: six weeks of Pb beam at 40A GeV/c for charm hadron measurements in Pb+Pb collisions.

Physics with secondary hadron beams: A series of measurements is planned to further refine estimates of the LBNF neutrino flux at the DUNE detectors. These measurements will require the following beam configurations:

- (i) **2022**: four weeks of K⁺ beam at 60 GeV/c for thin-target graphite cross-section measurements,
- (ii) **2022**: four weeks of proton beam at 120 GeV/c for thin-target titanium cross-section measurements,

- (iii) **2023:** four weeks of 120 GeV/c proton beam for measurements on a LBNF/DUNE prototype target.

2.5. Share of responsibility

JINR contributions/responsibilities:

- Construction of the TOF system based on MRPC;
- Software development and maintenance of the software library;
- Raw data reconstruction and DST production;
- Data analysis.

2.6. Scientific experience of authors

The authors of the project have a vast scientific experience. A. Malakhov, G. Melkumov and G. Lykasov possess the Doctor of Science degrees and contribute to study the problems of relativistic nuclear physics. Six young employees have been also actively involved into the Project. Five of them, V. Babkin, M. Buryakov, A. Dmitriev, R. Kolesnikov and M. Romyantsev, are developing the time-of-flight system for the NA61/SHINE project based on MRPC detectors. The members of the MRPC team use the knowledge gained during R&D and operation of the ToF systems for the NICA project. The other three employees, V. Kireyeu, A. Zaitsev, V. Lenivenko, have actively joined to the analysis of the experimental data. They all have publications and plans to prepare PhD theses.

2.7. Publications, PhD theses and presentations at conferences

In general, the JINR participants are co-authors of more than 100 publications on the NA61/SHINE experiment. As for 2019-2021 years, 15 articles [1-13, 17, 22] have already been published. In three of them, the Dubna group members are the principal co-authors. For the period of 2019-2021, 1 employee of the JINR group defended his PhD thesis and 1 doctoral dissertation and one PhD thesis are being

The members of the JINR group made 5 presentations on the NA61 results at the international meetings and conferences [6, 23, 24]. The pandemic has affected the participation in a large number of conferences.

3. Manpower resources

Tables 1 and 2 show the participants of the NA61 JINR experiment with the directions of the research and share of their participation. Table 3 shows the age of the young employees.

Table 1. VBLHEP manpower.

No	Name	Category	FTE
1	Babkin V.	MRPC	0.2
2	Buryakov M.	MRPC	0.2
3	Dmitriev A.	MRPC	0.5
4	Kireyeu V.	Analysis, data taking	0.5

5	Kolesnikov R.	MRPC	0,3
6	Kolesnikov V.	Analysis	0.1
7	Lenivenko V.	Analysis, data-taking	0.1
8	Malakhov A.	Analysis, data taking	0.3
9	Melkumov G.	Analysis, data taking	0.8
10	Rumyantsev M.	MRPC	0.2
11	Zaitsev A.	Analysis, data taking	0.8
Σ			4.0

Table.2. LNP manpower.

№	Name		FTE
1	Lykasov G.	Theory	0.1
2	Lyubushkin V.	Analysis, data taking	0.2
3	Popov B.	Analysis	1.0
4	Tereshenko V.	MRPC, data taking	0.3
Σ			1.6

Table 3. The age of young employees.

№	Name	Age (years)
1	Babkin V.	37
2	Buryakov M.	29
3	Dmitriev A.	28
4	Kireyeu V.	30
5	Kolesnikov R.	35
6	Lenivenko V.	30
7	Rumyantsev M.	29
8	Zaitsev A.	29

4. Estimation of the project budget (form No. 26), expenses for 3 years

Form № 26

Proposed timetable and necessary resources for the implementation
of the NA61 project (JINR participation)

Expenditures, resources, financing sources		Cost (k\$) Resource requirements		Proposal of the Laboratory in the distribution of finances and resources						
				2022		2023		2024		
				Theme 1087	Theme 1124	Theme 1087	Theme 1124	Theme 1087	Theme 1124	Theme 1087
Expendi- ture	Main units of equipment, work towards its updating, adjustment, etc.	15	-	5	-	5	-	5	-	
	Construction /repair of premises	-	-	-	-	-	-	-	-	
	Materials	270	-	140	-	110	-	20	-	
Required resources	Stan- dard hour	LHEP design bureau	-	-	-	-	-	-	-	-
		JINR Work- shop	-	-	-	-	-	-	-	-
		LHEP Work- shop	-	-	-	-	-	-	-	-
		Nuclotron	-	-	-	-	-	-	-	-
Σ		285	-	145	-	115	-	25	-	
Total:		285		145		115		25		
Financing sources	Budget. Theme 1087	285		145		115		25		

Theme 1087 - VBLHEP.

Theme 1124 - DLNP

PROJECT LEADER



A.I. Malakhov

9.02.2021

5. Estimation of expenditures (Form № 29)

Form № 29

Estimated expenditures for the Project: "Study of Hadron Production in Hadron-Nucleus and Nucleus-Nucleus Collisions at the CERN SPS (NA61/SHINE – SPS Heavy Ion and Neutrino Experiment)"

№	Name of the items cost	full cost (k\$)		2022		2023		2024	
		Theme 1087	Theme 1124	Theme 1087	Theme 1124	Theme 1087	Theme 1124	Theme 1087	Theme 1124
1.	Accelerator (Nuclotron), hour	-	-	-	-	-	-	-	-
2.	Computer communications	3	-	1	-	1	-	1	-
3.	LHEP Design bureau	-	-	-	-	-	-	-	-
4.	LHEP Workshop	-	-	-	-	-	-	-	-
5.	Materials	270	-	140	-	110	-	20	-
6.	Equipment	15	-	5	-	5	-	5	-
7.	Payment research	-	-	-	-	-	-	-	-
8.	Travel allowance, including:	178	24	60	8	60	8	58	8
	(a) to non-rouble zone countries	150	12	50	4	50	4	50	4
	b) in the rouble zone	4	-	2	-	2	-	-	-
	c) protocol-based	24	12	8	4	8	4	8	4
	Σ	466	24	206	8	176	8	84	8
	Total direct expenses:	490		214		184		92	

Theme 1087 - VBLHEP

Theme 1124 - DLNP

PROJECT LEADER

A.I. Malakhov

VBLHEP DIRECTOR

V.D. Kekelidze

DLNP DIRECTOR

V.A. Bednyakov

VBLHEP CHIEF ENGINEER-ECONOMIST

G.G. Volkova

DLNP CHIEF ENGINEER-ECONOMIST

6. Strengths, weaknesses, opportunities, threats

The strengths of the project are as follows:

- completing the second high-resolution time-of-flight TOF wall;
- relevance of the NA61/SHINE experimental program to modern challenges of fundamental science;
- modern experimental facility with unique parameters;
- a large amount of experimental data collected for proton-nucleus and nucleus-nucleus interactions in a wide energy range (from 13 to 158A·GeV)
- extensive experience for experimental data analysis;
- a large number of young employees;
- the opportunity of training young people for the NICA project.

Weak points if found in the Project are justified to be negligible.

7. References

1. A. Aduszkiewicz, ..., V. Babkin, M. Buryakov, A. Dmitriev, V. Golovatyuk, V. A. Kireyeu, V. I. Kolesnikov, A. Krasnoperov, V. V. Lyubushkin, A. I. Malakhov, V. Matveev, G. L. Melkumov, B. A. Popov, M. Romyantsev et al., Phys. Rev. C 102 no. 1, (2020) 011901.
2. A. Acharya, ..., V. Babkin, M. Buryakov, A. Dmitriev, V. Golovatyuk, V. A. Kireyeu, V. I. Kolesnikov, A. Krasnoperov, V. V. Lyubushkin, A. I. Malakhov, V. Matveev, G. L. Melkumov, B. A. Popov, M. Romyantsev et al. Measurements of π^\pm , K^\pm , p and anti- p spectra in $^7\text{Be}+^9\text{Be}$ collisions at beam momenta from 19A to 150A GeV/c with the NA61/SHINE spectrometer at the CERN SPS. Eur. Phys. J. C (2021) 81:73.
3. V. Kireyeu, Cluster dynamics studied with the phase-space Minimum Spanning Tree approach, arxiv.org/abs/2103.10542
4. A. Aduszkiewicz, ..., V. Babkin, M. Buryakov, A. Dmitriev, V. Golovatyuk, V. A. Kireyeu, V. I. Kolesnikov, A. Krasnoperov, V. V. Lyubushkin, A. I. Malakhov, V. Matveev, G. L. Melkumov, B. A. Popov, M. Romyantsev et al. Measurements of Ξ^- and anti- Ξ^+ production in proton-proton interactions at $\sqrt{s_{\text{NN}}} = 17.3$ GeV in the NA61/SHINE experiment. Eur. Phys. J. C (2020) 80:833.
5. N. Davis [NA61/SHINE Collaboration]. Searching for the critical point of strongly interacting matter in nucleus-nucleus collisions at CERN SPS. arXiv:2002.06636v1 [nucl-ex] 16 Feb 2020.
6. A. I. Malakhov, G. I. Lykasov. Mid-rapidity dependence of pion production in p-p and A-A collisions. Eur. Phys. J. A (2020) 56: 114.
7. Gennady Lykasov and Alexander Malakhov. Hadron production in pp and AA collisions at mid-rapidity within self-similarity approach. E Web of Conferences PJ 204, 01022 (2019).
8. A. Aduszkiewicz et al., [NA61/SHINE Collab.] Search for an exotic $S = -2$, $Q = -2$ baryon resonance in proton-proton interactions at $\sqrt{s_{\text{NN}}} = 17.3$ GeV. Phys. Rev. D 101 no. 5, (2020) 051101, arXiv:1912.12198 [hep-ex].
9. A. Aduszkiewicz et al., [NA61/SHINE Collab.] Measurement of ϕ meson production in p + p interactions at 40, 80 and 158 GeV/c with the NA61/SHINE spectrometer at the CERN SPS. Eur. Phys. J. C 80 no. 3, (2020) 199, arXiv:1908.04601 [nucl-ex].

10. A. Aduszkiewicz et al., [NA61/SHINE Collab.] $K^*(892)^0$ meson production in inelastic p+p interactions at 158 GeV/c beam momentum measured by NA61/SHINE at the CERN SPS. Eur. Phys. J. C 80 no. 5, (2020) 460, arXiv:2001.05370 [nucl-ex].
11. A. Aduszkiewicz et al., Two-particle correlations in azimuthal angle and pseudorapidity in central ${}^7\text{Be}+{}^9\text{Be}$ collisions at the CERN Super Proton Synchrotron [NA61/SHINE Collab.] arXiv:2006.02153 [nucl-ex].
12. A. Aduszkiewicz et al., [NA61/SHINE Collab.] Measurements of hadron production in $\pi^+ + \text{C}$ and $\pi^+ + \text{Be}$ interactions at 60 GeV/c. Phys. Rev. D 100 no. 11, (2019) 112004, arXiv:1909.06294 [hep-ex].
13. R. R. Prado, [NA61/SHINE Collab.] Recent results from the cosmic ray program of the NA61/SHINE experiment. EPJ Web Conf. 208 (2019) 05006, arXiv:1810.00642 [hep-ex].
14. A. Aduszkiewicz, [NA61/SHINE Collaboration Collab.], "Study of Hadron-Nucleus and Nucleus-Nucleus Collisions at the CERN SPS: Early Post-LS2 Measurements and Future Plans," Tech. Rep. CERN-SPSC-2018-008. SPSC-P-330-ADD-10, CERN, Geneva, Mar, 2018. <https://cds.cern.ch/record/2309890>.
15. A. Aduszkiewicz, [NA61/SHINE Collaboration Collab.], "Reply to the SPSC questions on Addendum CERN-SPSC-2018-008 entitled Study of Hadron-Nucleus and Nucleus-Nucleus Collisions at the CERN SPS: Early Post-LS2 Measurements and Future Plans," Tech. Rep. CERN-SPSC-2018-019. SPSC-P-330-ADD-11, CERN, Geneva, Jun, 2018. <https://cds.cern.ch/record/2621751>.
16. 2020. Technical Design Reports for upgrade of the NA61/SHINE detector subsystems, <https://edms.cern.ch/document/2422986/1>.
17. A.I.Malakhov, V.A.Matveev. New results and research perspectives of experiment NA61/SHINE on SPS at CERN. JINR News, No.3, 2020, pp.12-17.
18. Report from the NA61/SHINE experiment at the CERN SPS. The NA61 Collaboration. CERN-SPSC-2020-023 / SPSC-SR-278.
19. A. Aduszkiewicz, [NA61/SHINE Collaboration Collab.], "Study of Hadron-Nucleus and Nucleus-Nucleus Collisions at the CERN SPS: Early Post-LS2 Measurements and Future Plans," Tech. Rep. CERN-SPSC-2018-008. SPSC-P-330-ADD-10, CERN, Geneva, Mar, 2018. <https://cds.cern.ch/record/2309890>.
20. "Minutes of the 130th Meeting of the SPSC, Thursday and Friday, 7-8 June 2018," Tech. Rep. CERN-SPSC-2018-020. SPSC-130, CERN, Geneva, Jun, 2018. <http://cds.cern.ch/record/2622174>.
21. "Minutes of the 232nd meeting of the Research Board, held on 11 March 2020," Tech. Rep. CERN-DG-RB-2020-495. M-232, CERN, Geneva, Mar, 2020. <http://cds.cern.ch/record/2712812>.
22. Lykasov, G.I., Malakhov, A.I. and Zaitsev, A.A. Ratio of cross-sections of kaons to pions produced in pp collisions as a function of \sqrt{s} . Eur. Phys. J. A 57, 91 (2021).
23. Georgy Melkumov (NA61 Collaboration). Recent results of strong interaction program from NA61/SHINE experiment at CERN SPS. EPJ Web of Conferences 204, 01010 (2019).
24. Alexander Malakhov and Gennady Lykasov. Analytical description of hadron production in hadron-hadron and nuclear-nuclear collisions in the mid-rapidity region. EPJ Web of Conferences 204, 01021 (2019).

8. Appendix

8.1. Prof. V. Burov referee report

Reference on prolonging project NA61/SHINE in 2022-2024 years (JINR participation)

NA61/Shine is a multi-purpose experiment to study hadron-proton, hadron-nucleus and nucleus-nucleus collisions. The broad range momentum of beam particles, from pions to lead nuclei, together with the large acceptance and high resolution NA61/SHINE detector gives a unique opportunity of carrying out the needed measurements.

The offered project is a continuation of successful participation of the JINR group of employees from Veksler and Baldin Laboratory of High Energy Physics and Dzelepov Laboratory of Nuclear Problems of JINR in the experiment NA61/SHINE at the CERN Super Proton Synchrotron (SPS).

It is proposed to continue studying the properties of hadron and nuclear fragmentation in processes with hadron and nuclear beams. The results of searching for a critical point in the phase diagram of nuclear matter by scanning the energy and atomic numbers of interacting nuclei are described in more detail.

Data analysis continues in the following areas:

- study of the formation of light nuclei in nuclear interactions;
- study of hyperon generation in Be+Be, Ar+Sc, Xe+La, Pb+Pb interactions;
- study of the antimatter production in the nucleus-nuclear interactions.

The NA61 collaboration has carried out a lot of work on the modernization of the setup in 2019-2021. Physicists at the High Energy Physics Laboratory have constructed a new time-of-flight system based on MRPC detectors. This system should be supplemented with another time-of-flight wall for registering particles of the both charge signs in 2022. This is not a very big job, since the gas system has already been made for the both walls and there is a reserve for producing detectors.

This document gives a review of the physics research programme on relativistic nuclei interactions and describes unique experimental results obtained during the previous three years with active participation of the JINR employees in the project NA61. There are also plans of the joint work in the framework of the experiment for a period of 2022-2024 years.

First of all, now it is necessary to carry out analysis of a huge number of the accommodated data, complete modernization of the set-up and provide the performance of the runs.

The experiment carries out a comprehensive and consequent study of hadron interactions starting from elementary nucleon-nucleon processes till the collisions of heavy ions having different atomic numbers and beam energies (20A·GeV-158 A·GeV).

The participants of the project are co-authors of numerous publications and presentations on this topic which are widely quoted in the world literature.

Further participation in experiment NA61 will allow the physicists to continue systematic studying of nucleus-nucleus interactions starting from light nuclei till the heavy ones including the nuclei of the middle sizes. For this programme the studies at the set-up NA61 are extremely valuable and still beyond the competition due to unique parameters of the facility and availability of nuclei beams at SPS in CERN.

It is important to emphasize that the beam momentum range provided for NA61/SHINE by SPS is very important for the heavy ion, neutrino and cosmic ray communities. There is a world-wide effort to construct new facilities providing ion and hadron beams for the CERN SPS beam momentum range. They are: the fixed-target facilities at FAIR, Germany, and J-PARC, Japan, as well as the collider facility NICA, Russia. They will start operation after the results needed for the project to be completed. The data from the collider facilities are typically complementary to

the corresponding fixed target results. In particular, charm hadron measurements are only possible at the fixed target facilities providing the collision energy and data taking rate to be high enough. NA61/SHINE is the only experiment which carries out the requested measurements in the near future. Moreover, the needed operation of NA61/SHINE beyond Long Shutdown 2 would allow physicists to efficiently extend the programme of new measurements, if necessary.

In addition, the JINR group participation in the NA61 experiment is necessary in the framework of training young professionals for the NICA project. On physics close to the NICA programme, in the frame of the NA61 project there are two doctoral and three candidate dissertations defended. It is planned to prepare two PhD theses and doctor dissertation using the results obtained in the NA61 experiment and simulations for the NICA project at the nearest time.

The experienced personnel who have defended their doctoral and PhD theses based on the results of the NA61 experiment are successfully working on the NICA project.

The modest financial requests are quite justified to obtain physics results and, as expected, they will be a significant contribution to the research programme of JINR.

It is necessary to stress that JINR participation in the experiment NA61 is very important since the research programme in this experiment lies in the main stream of the long-range programme in the field of relativistic nuclear physics at JINR. It is complementary to the studies being carried out at the Nuclotron (JINR), RHIC (BNL) and the obtained experimental results are needed for planning the research at the acceleration complexes of NICA (JINR) and FAIR (GSI).

From the mentioned above it is evident that participation of the JINR group in NA61 experimental data analysis and new measurements at this set-up are considered to be fruitful and should be recommended to prolong the JINR group participation for the next period of 3 years with first priority.

Doctor of Phys. and Math. Sciences,
Professor

 V.V.Burov

18.02.2021

Referee report on the NA61/SHINE project (JINR participation)

The experiment NA61 performs studies with beams of heavy ions accelerated at the superproton synchrotron (SPS, CERN) to an energy from 20 A GeV to 158 A GeV, as well as light secondary nuclei.

The JINR group of physicists participates extensively with the research in the framework of the experiment NA61. The collaboration NA61 performed a large work on upgrade of the installation in 2019-2021. Engineers and physicists of the Laboratory of High Energy Physics of the Joint Institute for Nuclear Research created the new time of flight registration system based on MRPC detectors which is the key detector for identification of charged particles. In 2022 one more fast time of flight system for registration of particles of both charge signs will be added to the installation in 2022.

The project NA61 has a vast research program in the most interesting field of relativistic nuclear physics: the study of the intermediate energy region from units to hundreds of GeV/nucleon for different types of interacting nuclei.

Initially, the research program of NA61/SHINE included the measurement of the yields of charged particles in p+p and central collisions of nuclei ${}^7\text{Be} + {}^9\text{Be}$, Ar+ Sc, p+ Pb, and Xe + La for momenta of 13, 19, 30, 40, 75, 150/158 GeV/c nucleon. Then the research program was extended, now it includes the investigation of collective phenomena in nucleus-nucleus collisions in the same energy range.

At present, the experimental data on proton-proton collisions and p+Pb, Be+Be, Ar+Sc, Xe+La, and Pb+Pb reactions are available. Thus, a large amount of experimental information in the framework of NA61/SHINE experiment has already been accumulated. It is very important that the obtained experimental data include reactions with light nuclei, beginning with protons, and up to the heaviest accelerated nuclei.

It should be underlined that the experimental results inspired certain theoretical studies, especially those related to the proof of the beginning of deconfinement at decreased energy. These studies will be continued in the future.

The JINR researchers made a significant contribution into the creation of the time of flight system and analysis of the obtained experimental results. The LHEP JINR group had complete responsibility for this part of the experiment: data accumulation, analysis, and publication of physical results. The collaboration in the framework of NA61 is efficient and fruitful for both research institutes, CERN and JINR. Three Cand.Sci and two Dr.Sci dissertations were defended at JINR based on the results obtained in the NA49/NA61 experiment.

The continuation of this cooperation will ensure a deeper insight in the properties of nuclear matter at relativistic energies. The participation of JINR in the experiment NA61 is also very important for preparation of young scientists for the NICA project whose physical program contains tasks close to those of the project NA61. The experience gained by the JINR team in working with various detectors at ion beams of SPS (CERN) can hardly be overestimated, as well as their participation in processing and analysis of experimental data.

It should be noted that relativistic nuclear physics is one of the main topics of research at JINR. And relativistic nuclear physics at intermediate and low energies is the main direction of research at the constructed collider NICA.

The installation NA61 is unique, and in my opinion, is the best of the operating world facilities aimed at studies of relativistic nuclear physics in the intermediate energy range.

The participation of the JINR team in the experiment NA61 is fruitful. The obtained physical results, undoubtedly, contribute to maintaining high scientific reputation of our institute. Moreover, the expected results will certainly make a substantial contribution into the development of long-term research programs in the field of relativistic physics with heavy ions at JINR. I recommend to approve the prolongation of JINR participation in the experiment NA61 in 2022-2024 with first priority within the requested funding.

Doctor of physical and mathematical sciences,

Head of group, LHEP JINR

24.02.2021



A.A.Baldin

8.3. Decision of the STC Laboratory

ВЫПИСКА ИЗ ПРОТОКОЛА заседания НТС ЛФВЭ от 16 марта 2021 года

Присутствовали на заседании 26 членов НТС из общего числа 37 членов НТС.

НТС ЛФВЭ заслушал отчет и рассмотрел предложение о продлении проекта «NA61» темы “Исследования по физике релятивистских тяжелых и легких ионов на ускорительных комплексах Нуклотрон-NICA ОИЯИ и SPS ЦЕРН” (02-1-1087-2009/2023). НТС решил одобрить отчет и рекомендовать ПКК по физике частиц продлить проект до конца 2024 года с первым приоритетом.

Рецензенты: В.В.Буров, А.А.Балдин.

Председатель НТС ЛФВЭ



Е.А.Строковский

Ученый секретарь НТС ЛФВЭ



С.П.Мерц

ABSTRACT OF THE MINUTES OF THE MARCH 16, 2021 VBLHEP STC MEETING

26 STC members were present at the meeting out of a total of 37 STC members.

VBLHEP STC heard the report and considered the proposal on continuation of the NA61 project within the framework of theme (02-1-1087-2009/2023) “Research on Relativistic Heavy and Light ion Physics. Experiments at the Accelerator Complex Nuclotron-NICA at JINR and CERN SPS”. STC decided to endorse the report and to recommend that PAC for Particle Physics support continuation of the project until the end of 2024 with first priority.

Referees: V.V.Burov, A.A.Baldin.

VBLHEP STC Chairman



E.A.Strokovsky

VBLHEP STC Scientific Secretary



S.P.Merts