



The XXVII International Scientific Conference of Young Scientists and Specialists (AYSS-2023)



Detector and physics simulation using heavy ion collisions at NICA-SPD

Scientific Supervisor: I. Denisenko^{1,a)}

Speaker: R. Pandey^{2,b)}

¹Joint Institute for Nuclear Research, Dubna, Russia

²Larsen & Toubro Limited, Faridabad, India

a) iden@jinr.ru

b) rishav160999@gmail.com

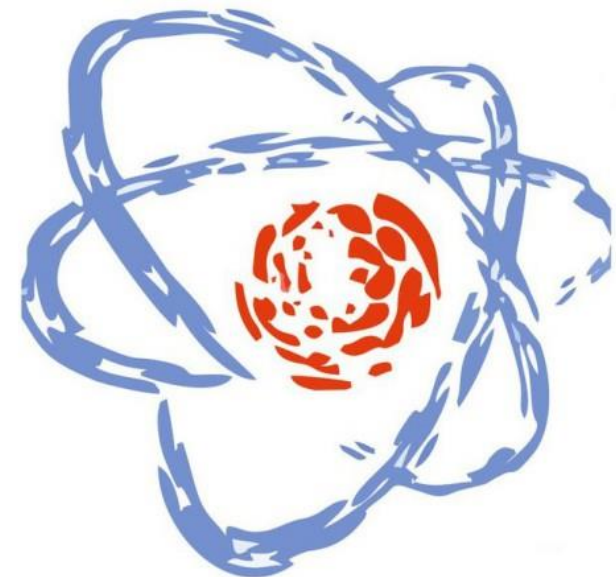

Aim of the work:

- The aim was to check the feasibility of hadron formation effects during heavy ion collisions at the first stage of SPD operation using Monte Carlo simulations.
- $^{12}\text{C} - ^{12}\text{C}$ and $^{40}\text{Ca} - ^{40}\text{Ca}$ heavy ion collisions at $\sqrt{s} = 11\text{A GeV}$ were simulated using the SMASH event generator.
- Firstly, the generator-level events were studied, then charged multiplicities and momentum spectra of different types of charged particles were obtained.
- Secondly, the generated events passed through the full reconstruction using the SpdRoot framework.
- At this stage particles were identified using dE/dx measurement and TOF information.
- Multiplicity and momentum spectra of reconstructed charged particles identified as $\pi^\pm/\text{K}^\pm/\text{p}^\pm$ separately for dE/dx and TOF were obtained at detector stage too.
- Finally, performance of the tracking systems were evaluated using purity spectra in both the collisions.

NICA Facility

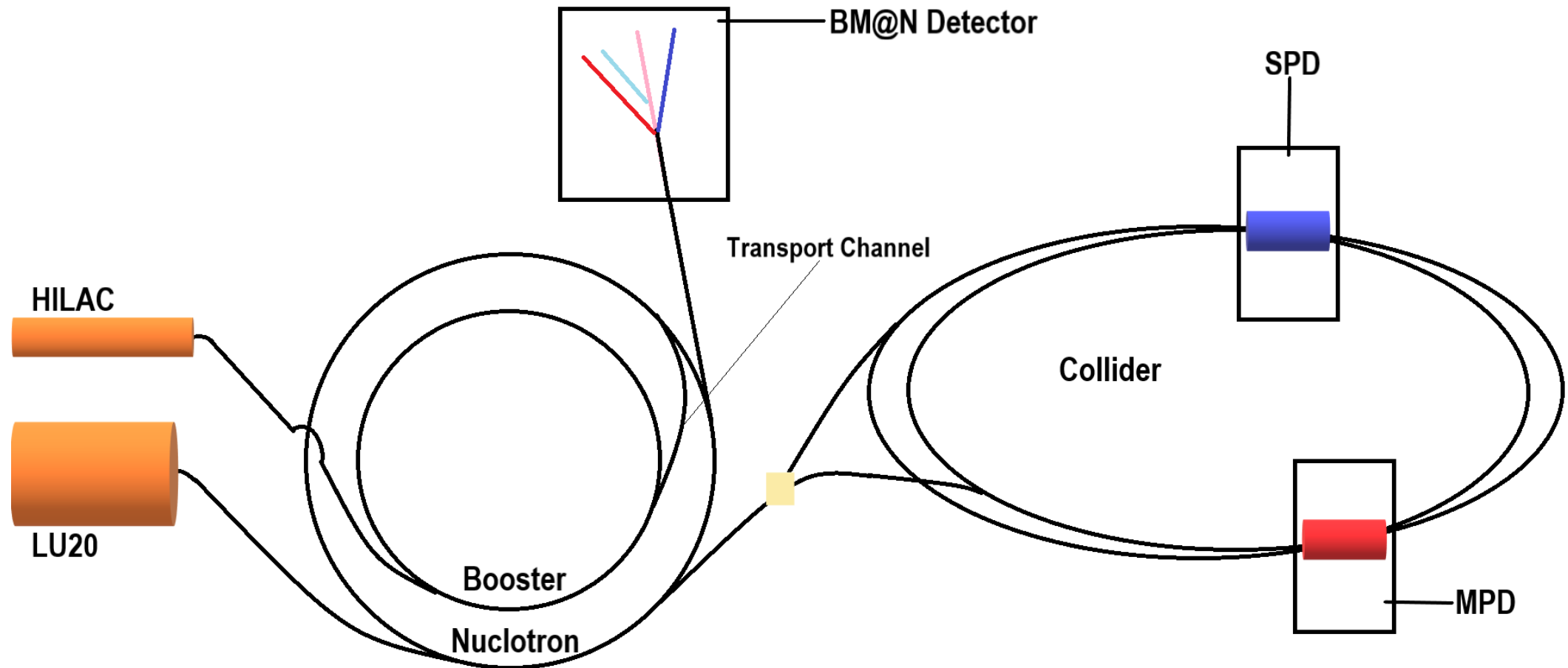

NICA (Nuclotron based Ion Collider fAcility) collider at JINR Dubna is being built to provide beams for two experiments, the MPD and SPD.

Main Parts:

1. Injection Complex:

- I. Injector for light ions – LASER, duoplasmatron sources, sources of polarized p^+ and d .
- II. Injector for heavy ions – KRION 6T (provides heavy ions up to Au)

2. Light Ion Linear Accelerator (LU20): Accelerates p^+ , d , and alpha-particles up to 5 MeV of K.E.

3. Heavy Ion LINAC (HILAC): Accelerates heavy ions up to Au with max. K.E. of 3.2 AMeV of K.E.

4. Booster: Accelerates heavy ions up to 660 MeV/n of relativistic energy, circumference = 211 m.

5. Nuclotron: Accelerates p^+ , d , and alpha-particles up to 13.5 GeV, and heavy ions up to 5.5 AGeV of relativistic energy, circumference = 250 m.

6. MPD (Multi Purpose Detector): To study properties of dense baryonic matter (matter present at extreme high density in QCD phase diagram) like Quark Gluon Plasma through heavy ion collisions.

7. SPD [1,2] (Spin Physics Detector): To study of spin related phenomenon and QCD, and will involve p-p, and d-d collisions.

8. BM@N Detector: For fixed target experiments.

9. Two storage rings each with a circumference of 503.04 m.

Note: Relativistic Energy = Rest mass energy + K.E.

Spin Physics Detector

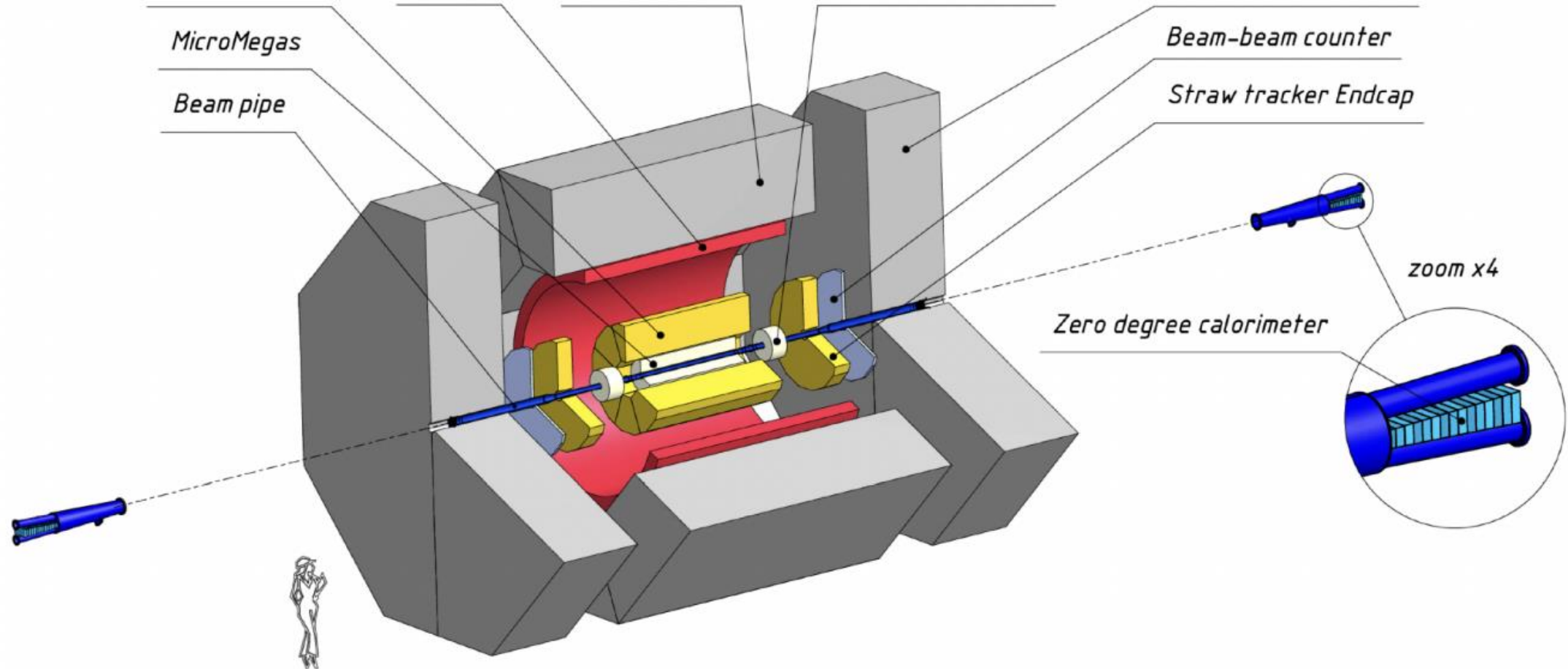

The Spin Physics Detector is a 4π universal detector optimized to study spin-related phenomena via open charm, charmonia, and prompt photons in the collisions of polarized p-p or d-d beams with \sqrt{s} up to 27 GeV. In first stage of NICA-SPD, the expected collision energy will be from 3.4 up to 10 GeV, and later after first upgrade, it is expected to reach up to 27 GeV.

Main Parts:

- (i) **Beam pipe:** Passes through the center of the detector, carries the accelerated beams of ions.
- (ii) **Central Tracker:** To identify primary vertex and to improve the momentum resolution and tracking efficiency of the tracking system.
- (iii) **Straw Tracker (ST) detector:** For reconstruction of primary and secondary particle tracks and for determination of their momenta. Also participates in particle identification of π , K, and p.
- (iv) **Time Of Flight (TOF) detector:** Part of Particle Identification (PID) system, and is used for identification of particles like π , k, and p with long trajectories.
- (v) **Magnet system:** shown by red color provides 1T of magnetic field along the beam axis.

Event Generation

- $^{12}\text{C} - ^{12}\text{C}$ and $^{40}\text{Ca} - ^{40}\text{Ca}$ heavy ion collisions at $\sqrt{s} = 11$ AGeV with maximum impact parameter set to 8 fm for C-C and 11 fm for Ca-Ca were simulated using SMASH.
- The fermi motion was assumed to be “frozen” and 100K events were generated for each heavy ion collision.

Generator Level Charged Track Multiplicity, for C-C and Ca-Ca

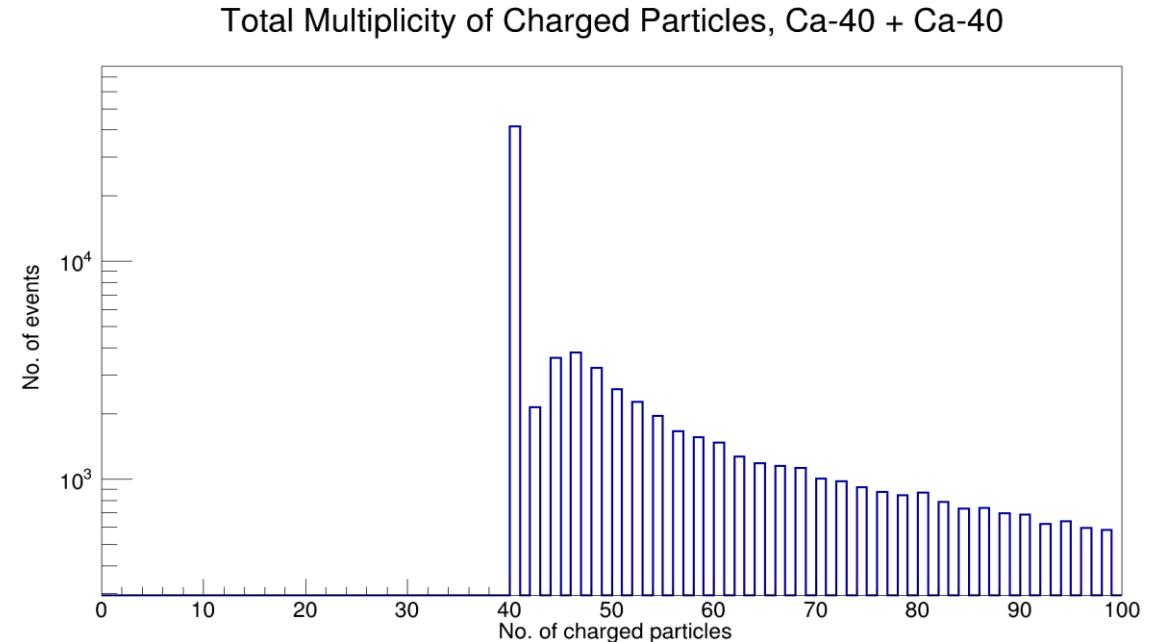
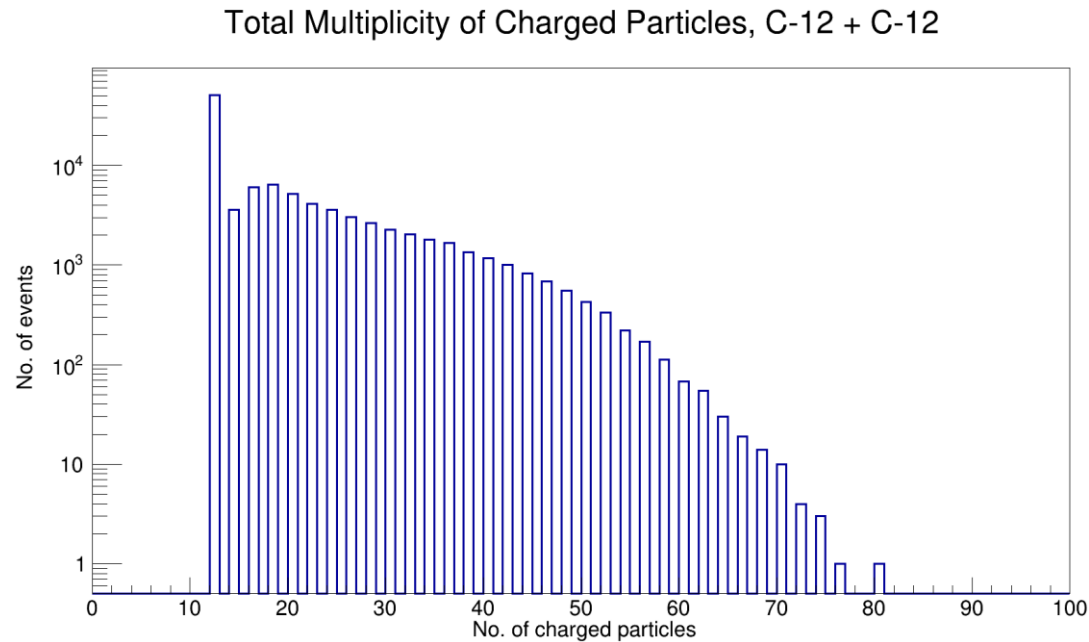

The peaks at 12 for $^{12}\text{C} - ^{12}\text{C}$ collisions and at 40 for $^{40}\text{Ca} - ^{40}\text{Ca}$ collisions correspond to events where no interaction occurred.

Generator Level Rapidity Distribution, for C-C and Ca-Ca

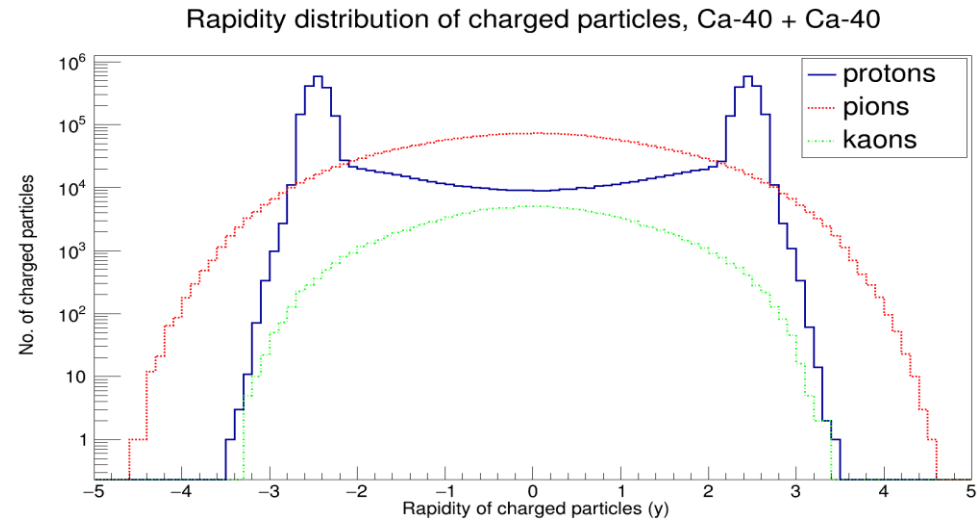
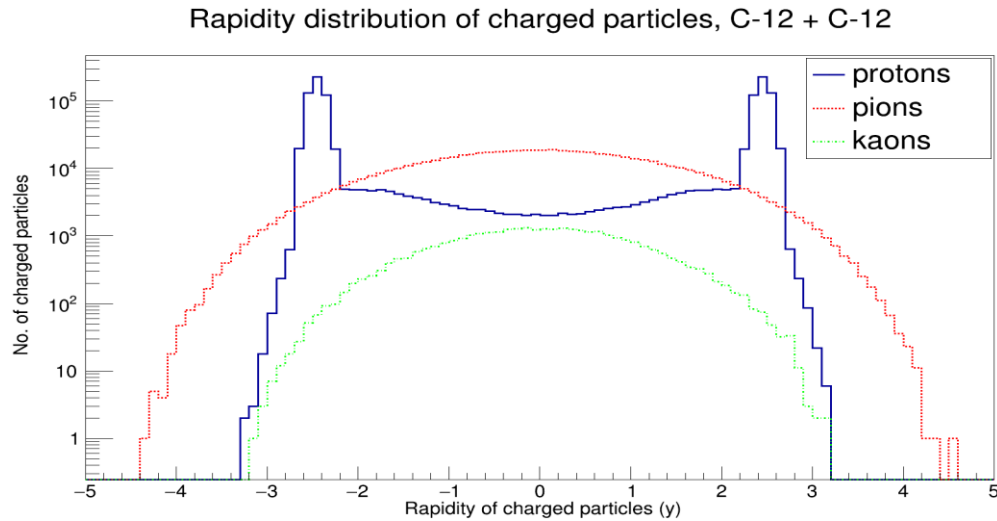

- Peaks for protons correspond to particles moving close to the initial beam direction.
- It can be seen that for $|y| < 2$ (i.e. within the acceptance of the detector) charge particles are dominated by pions.
- Apart from $p \pm$, $\pi \pm$, & $K \pm$, marginal numbers of sigmas, cascades, and omegas were also generated.

Generator Level Kinematic Distributions of Protons, Pions, and Kaons for C-C, Ca-Ca

Total momentum distribution of protons, C-12 + C-12

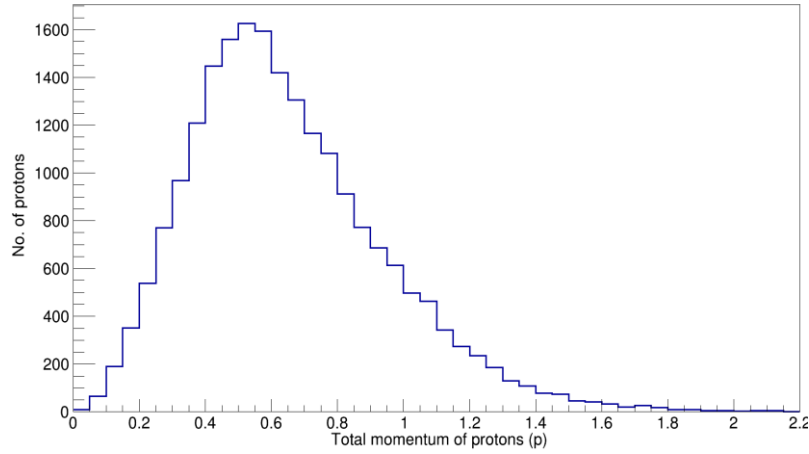

Total momentum distribution of pions, C-12 + C-12

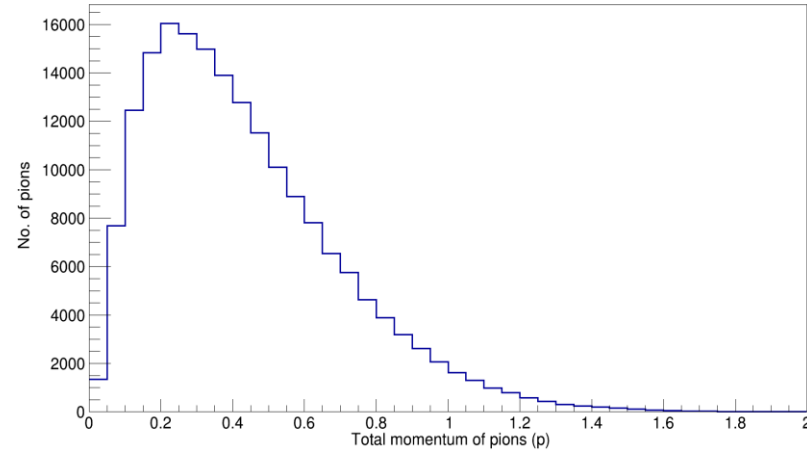

Total momentum distribution of kaons, C-12 + C-12

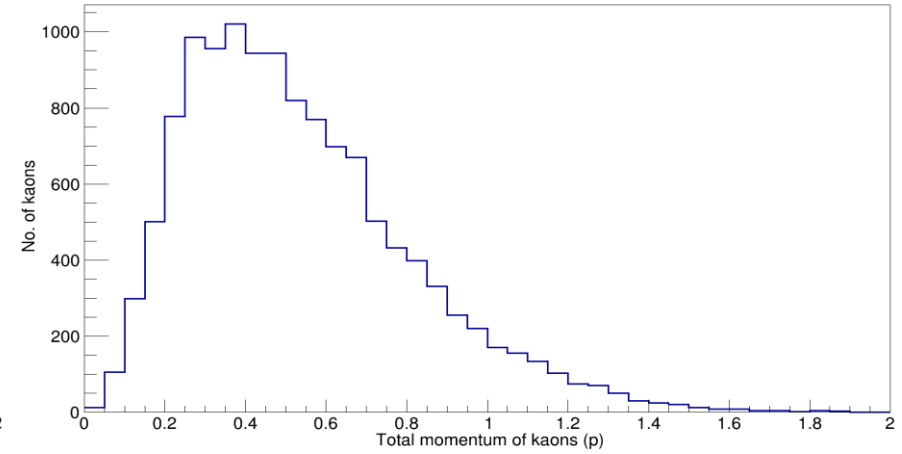

Total momentum distribution of protons, Ca-40 + Ca-40

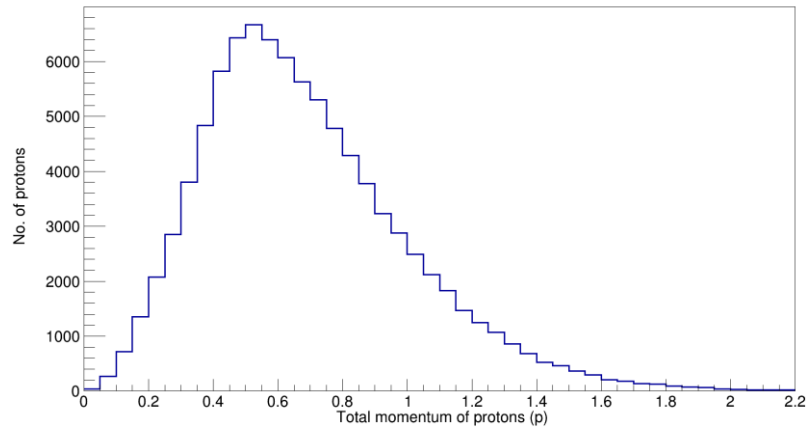

Total momentum distribution of pions, Ca-40 + Ca-40

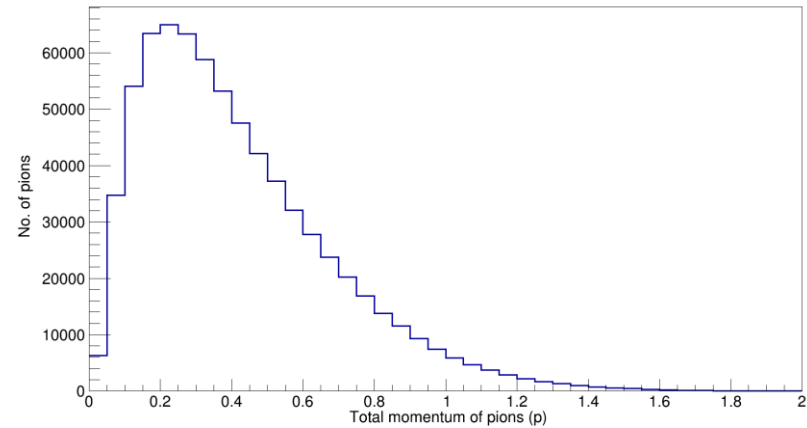

Total momentum distribution of kaons, Ca-40 + Ca-40

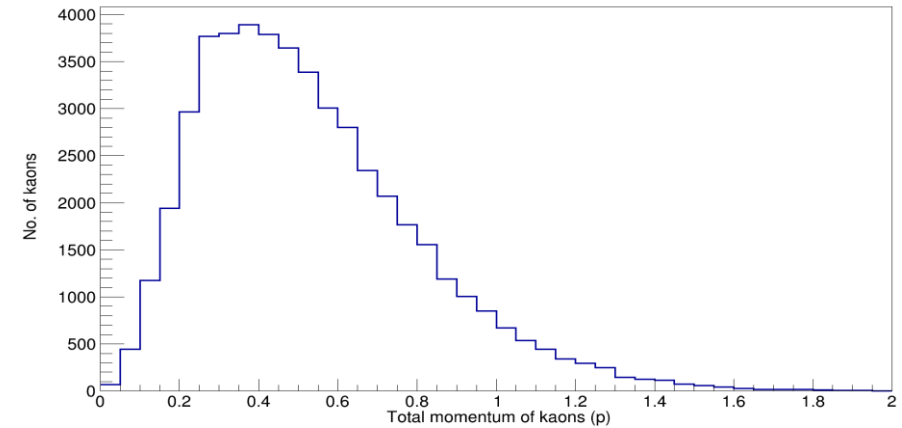

Detector Simulation and Event Reconstruction

- The detector simulation and reconstruction was performed with the SpdRoot framework.
- During the simulation stage the particles were transported through the detector geometrical model using Geant4.
- At the reconstruction stage, Geant4 tracks and vertices were reconstructed and particle identification with dE/dx and time of flight measurements was performed.
- Out of 100K events generated by SMASH, first 1K events were considered for detector simulation due to slow data processing in SpdRoot.

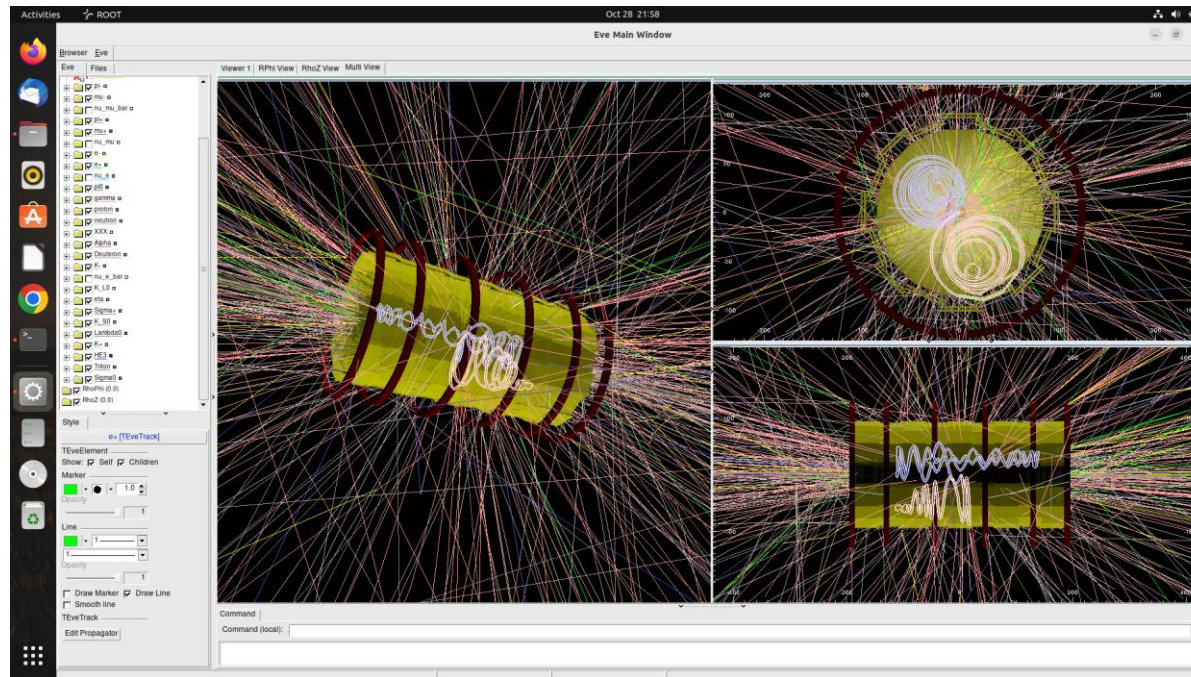
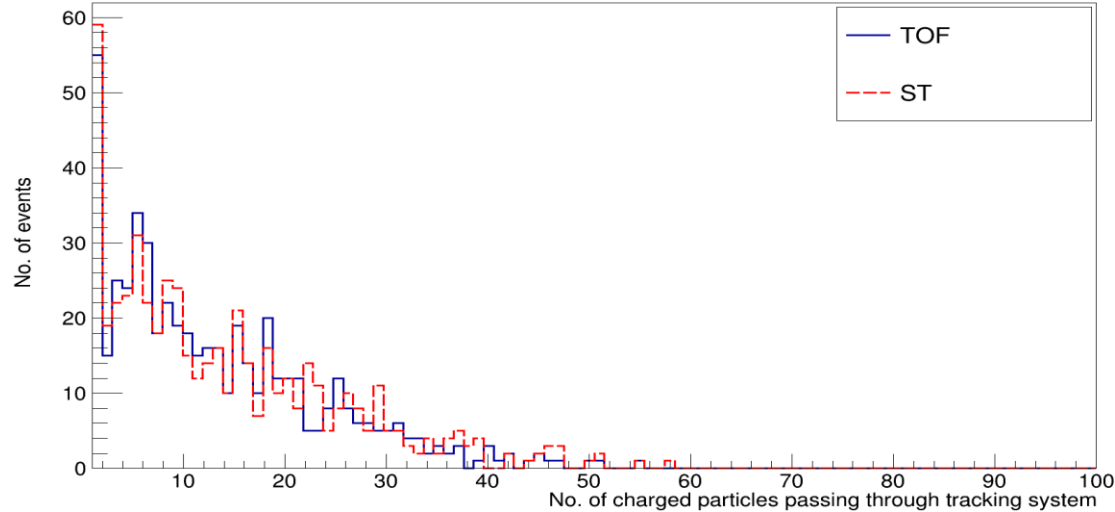

Fig. shows detector simulation and event reconstruction using SpdRoot

Physical Analysis

Detector Level Charged Track Multiplicity, for C-C and Ca-Ca

Total multiplicity of charged particles passing through tracking system, C12-C12



Total multiplicity of charged particles passing through tracking system, Ca40-Ca40

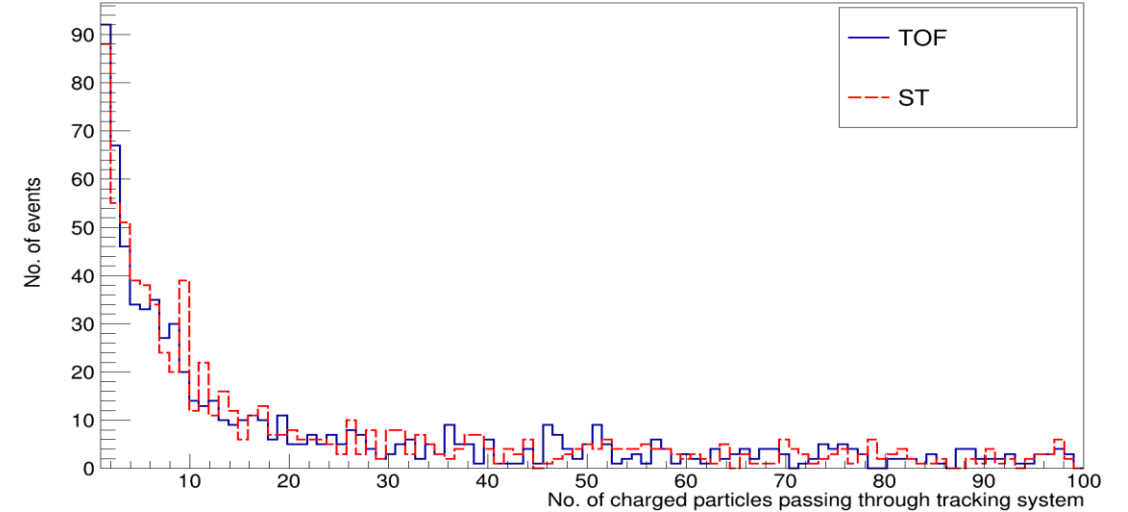

- Total multiplicity of charged particles reconstructed by the tracking system in $^{12}\text{C} - ^{12}\text{C}$ and $^{40}\text{Ca} - ^{40}\text{Ca}$ collisions is shown. The numbers of reconstructed tracks are much lower compared to generator-level studies.
- It is because the geometry of the tracking system is such that, tracks with polar angle, $\theta < 10^\circ$ or $> 170^\circ$ do not hit the tracker and passes along the beam pipe itself, so such tracks are ignored.
- Also, there were events without nuclei interactions which resulted in no track reconstruction. So, to avoid a large peak at zero due to mentioned reasons, the X-axis count starts from 1.

Detector Level Pion Momentum Spectra for C-C

Charged Particles Identified as Pions by ST, C12-C12

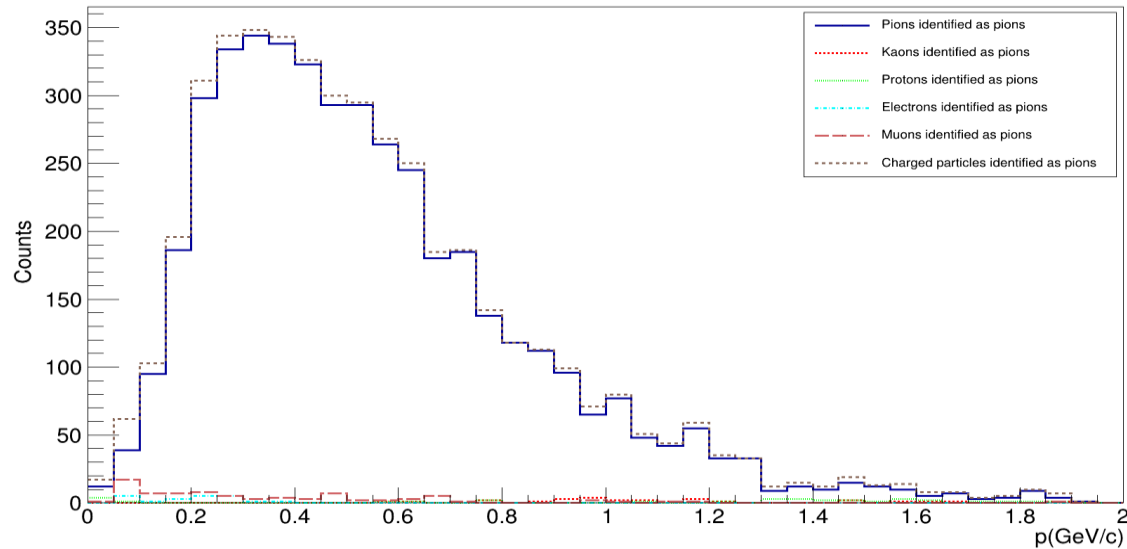

Charged Particles Identified as Pions by TOF, C12-C12

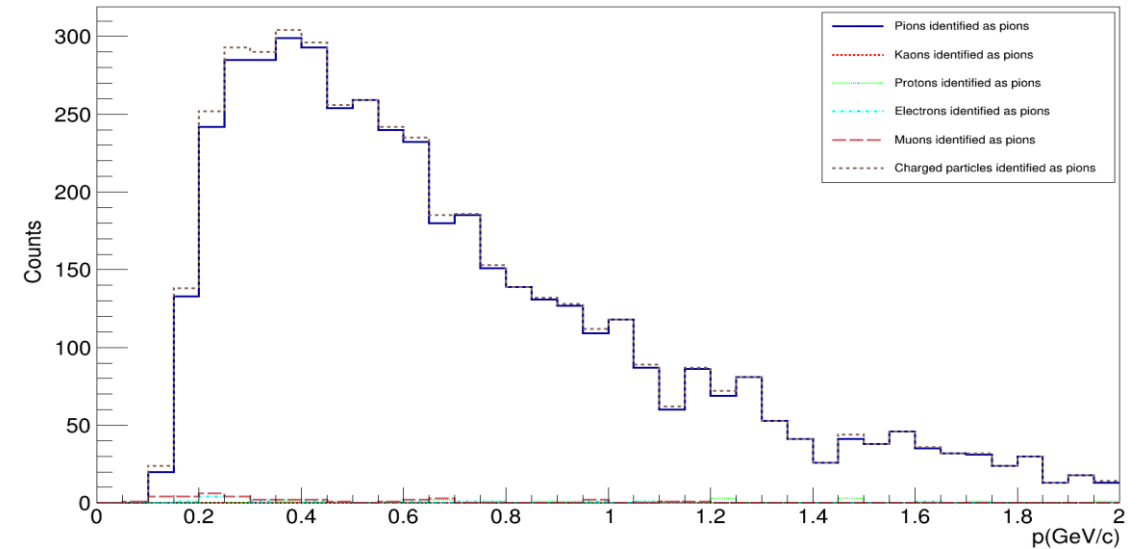

Pion spectra precision, C12-C12

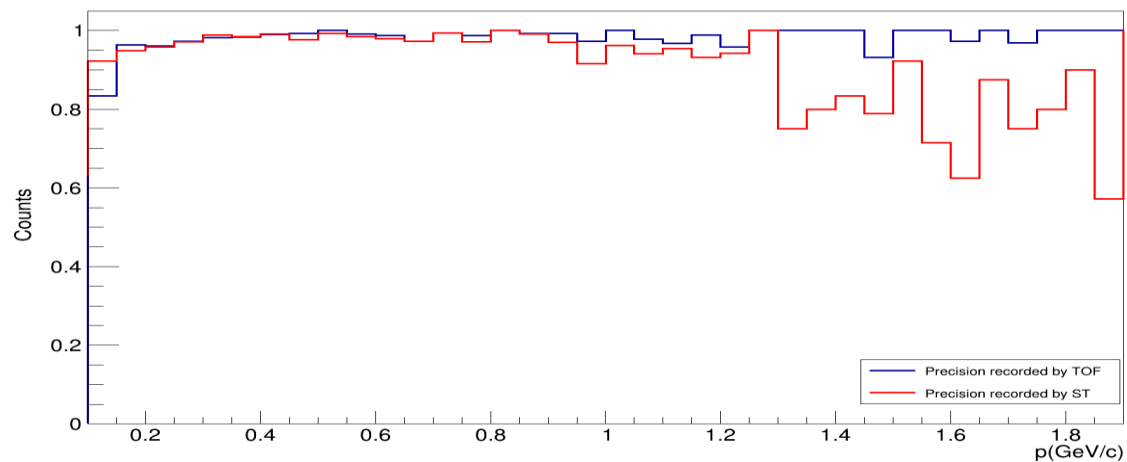

- The spectra show resemblance with the generator plot of pion momentum distribution.
- The obtained distribution for “pions identified as pions” only slightly deviates from distribution of all selected pion candidates. It can be seen that purity above 90% can be obtained up to 1.2 GeV using either dE/dx or TOF measurements.

Detector Level Pion Momentum Spectra for Ca-Ca

Charged Particles Identified as Pions by ST, Ca40-Ca40

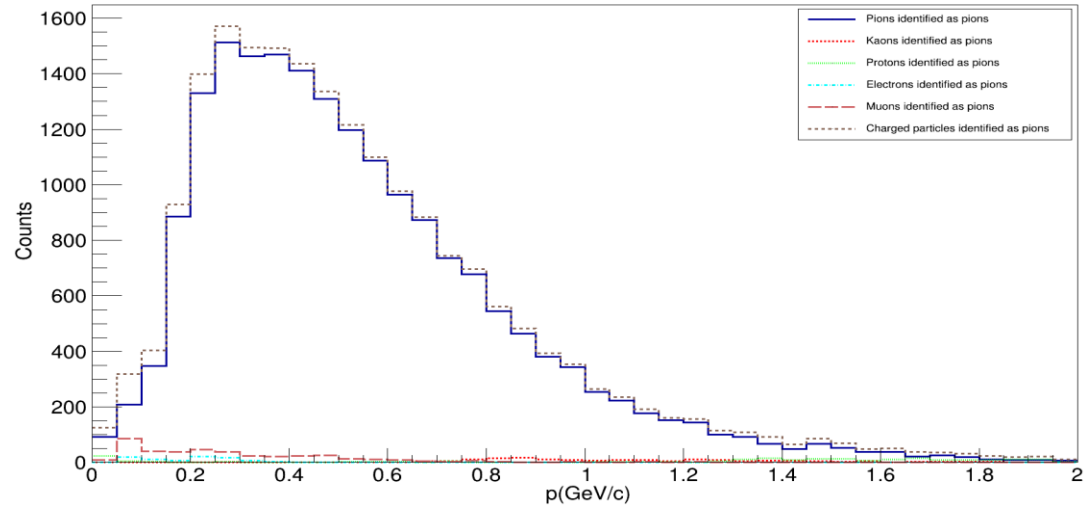

Charged Particles Identified as Pions by TOF, Ca40-Ca40

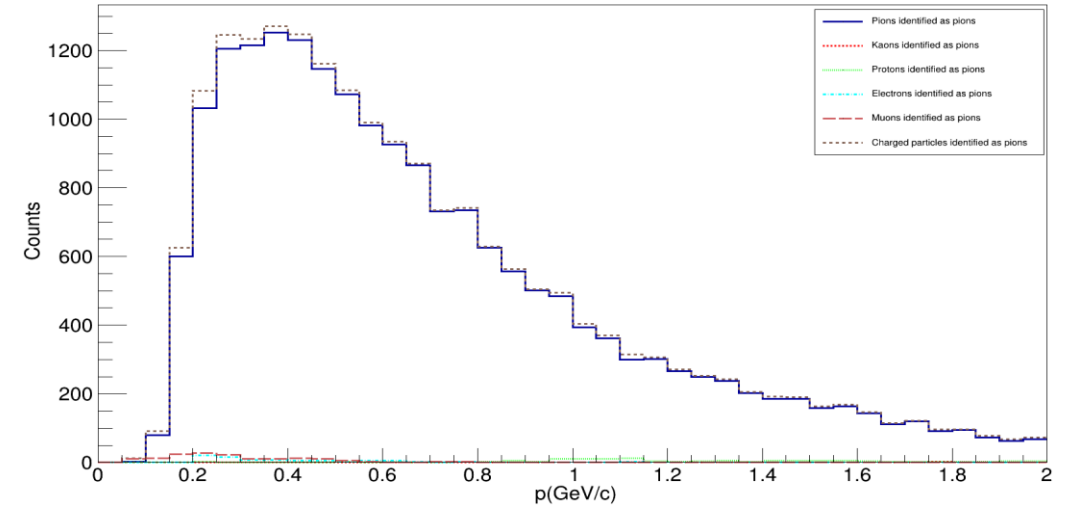

Pion spectra precision, Ca40-Ca40

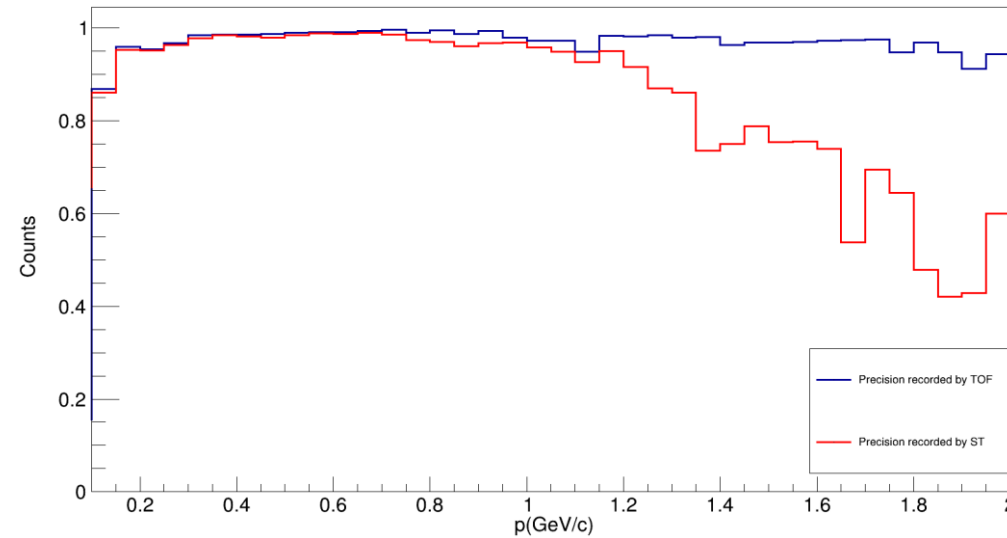

Detector Level Kaon Momentum Spectra for C-C

Charged Particles Identified as Kaons by ST, C12-C12

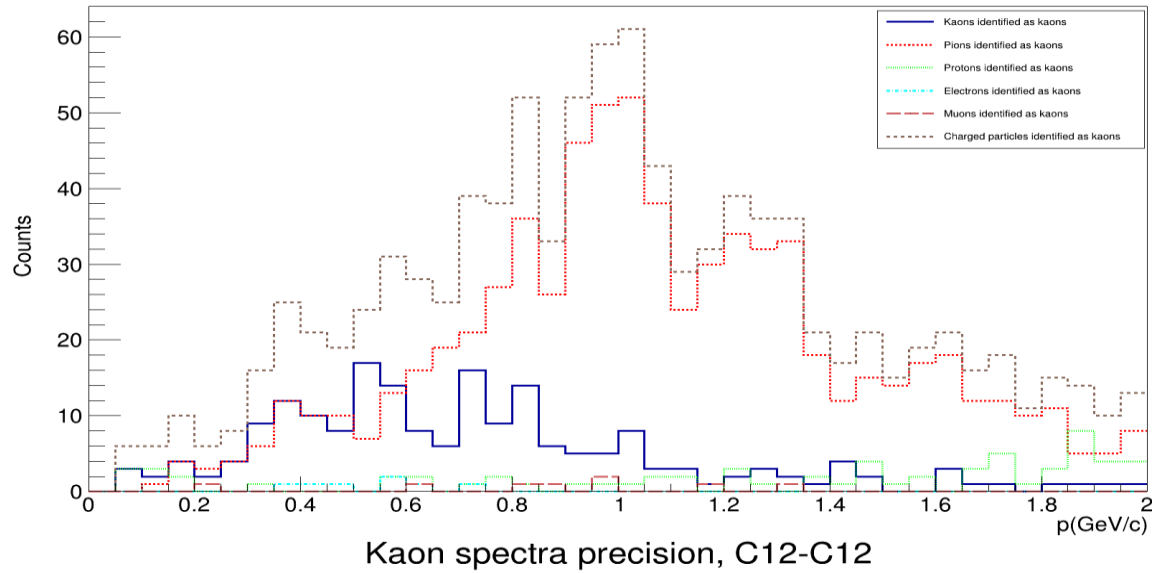

Charged Particles Identified as Kaons by TOF, C12-C12

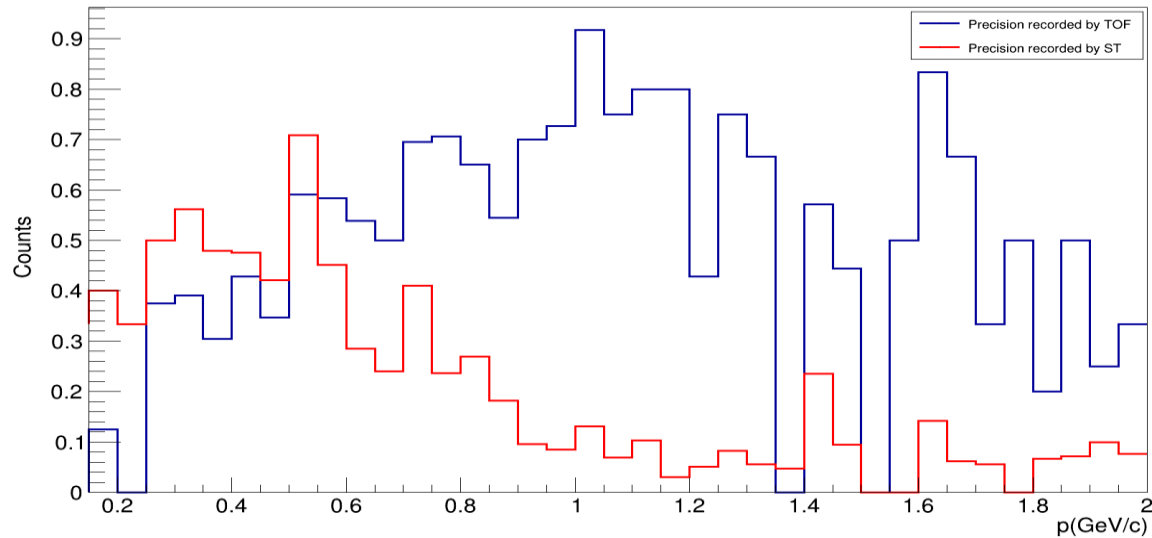
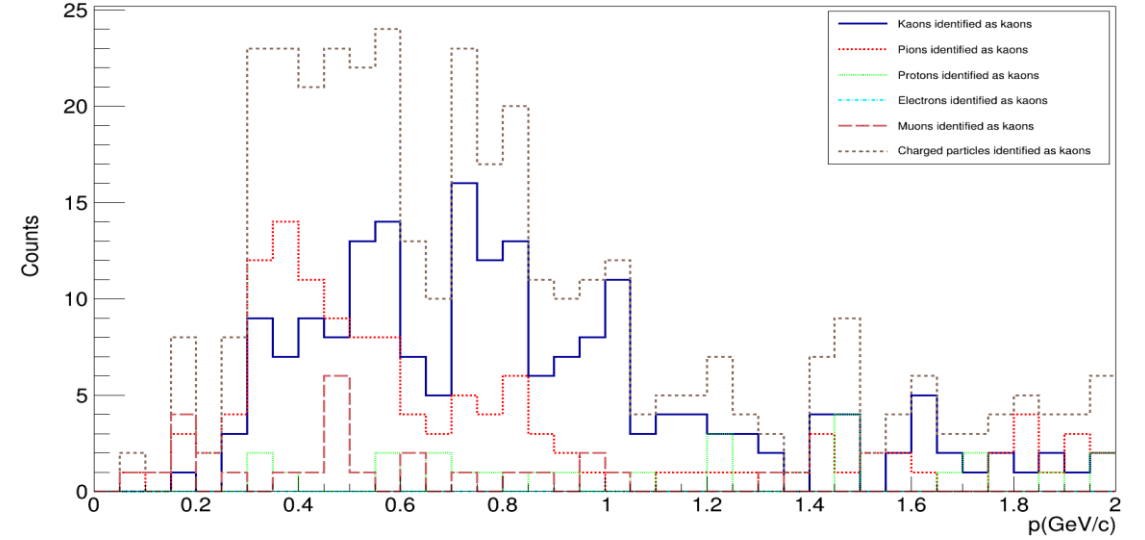

- The kaon momentum spectrum was explicitly mentioned among observables to study hadron formation effects in nuclei.
- First, the shown data lack statistics. Secondly, it can be seen that there is a huge contamination from misidentified pions.

Detector Level Kaon Momentum Spectra for Ca-Ca

Charged Particles Identified as Kaons by ST, Ca40-Ca40

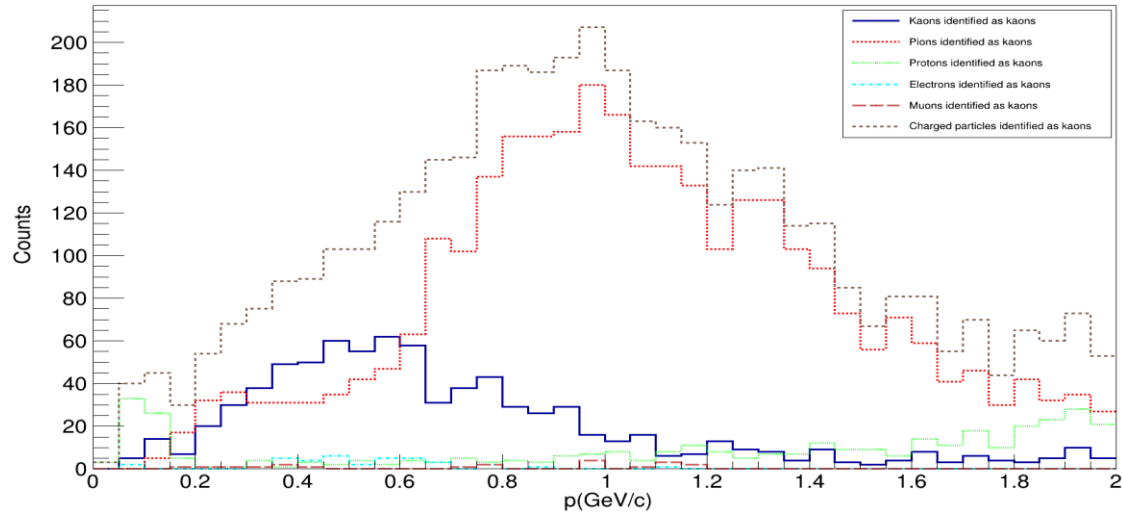

Charged Particles Identified as Kaons by TOF, Ca40-Ca40

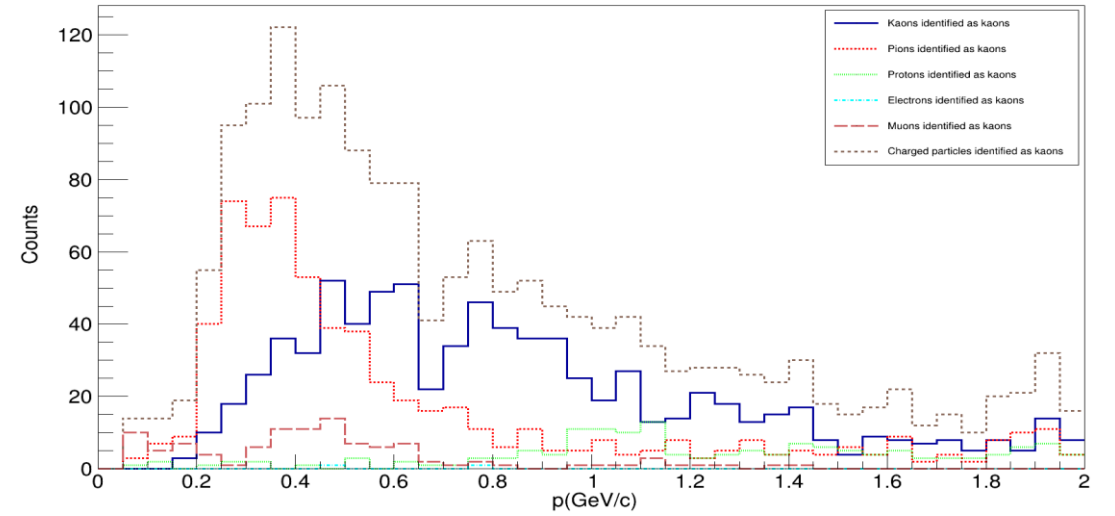

Kaon spectra precision, Ca40-Ca40

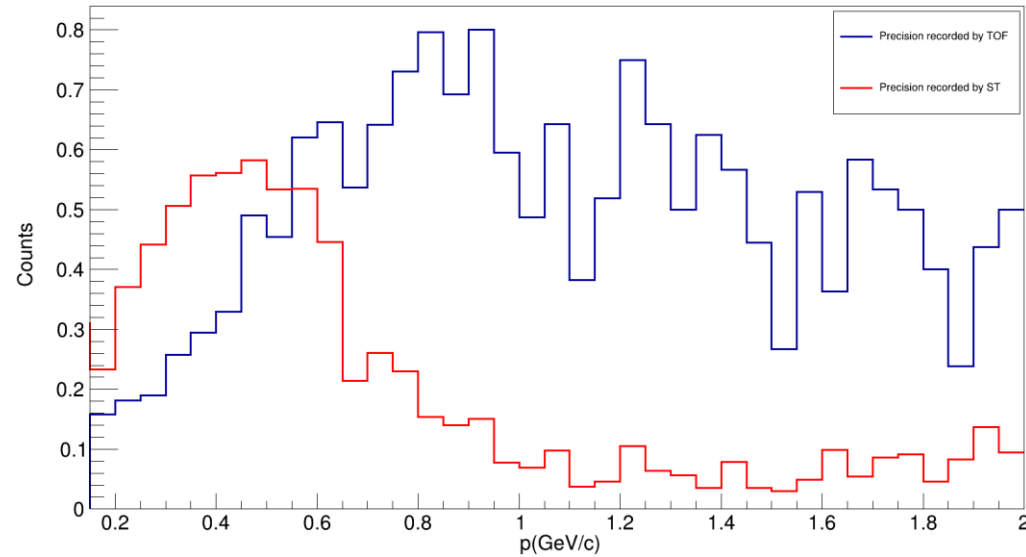

Detector Level Proton Momentum Spectra for C-C

Charged Particles Identified as Protons by ST, C12-C12

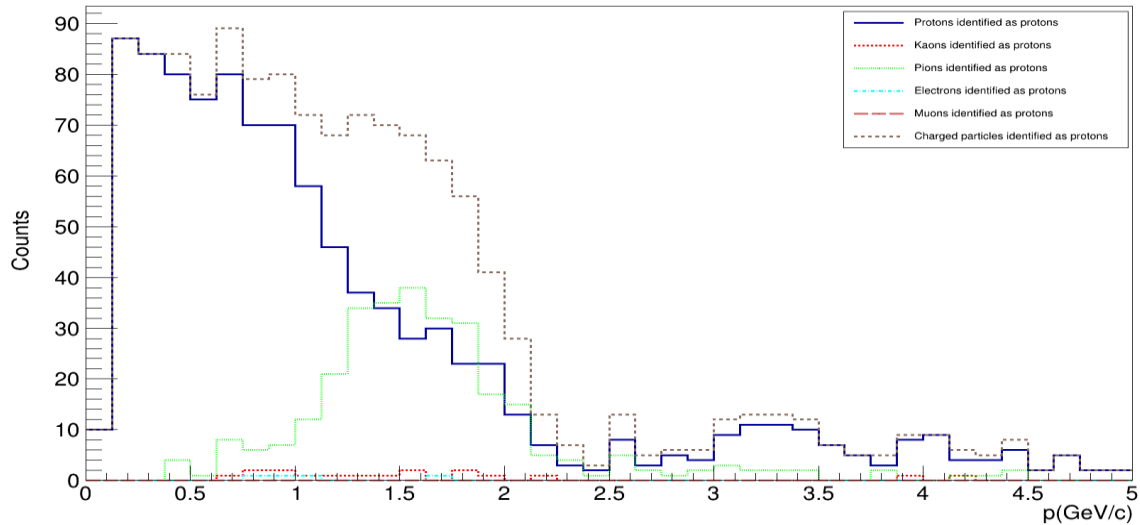

Charged Particles Identified as Protons by TOF, C12-C12

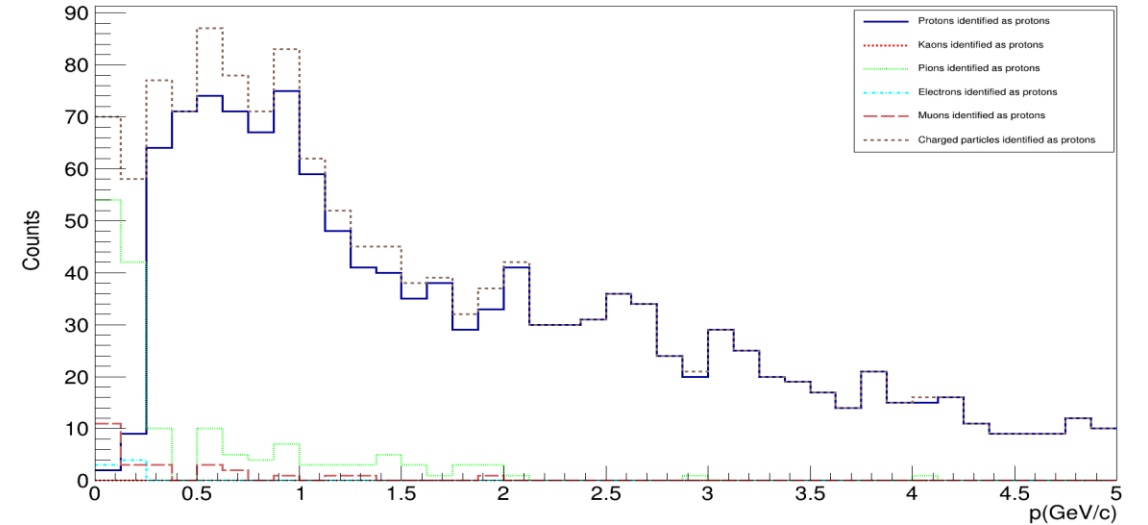

Proton spectra precision, C12-C12

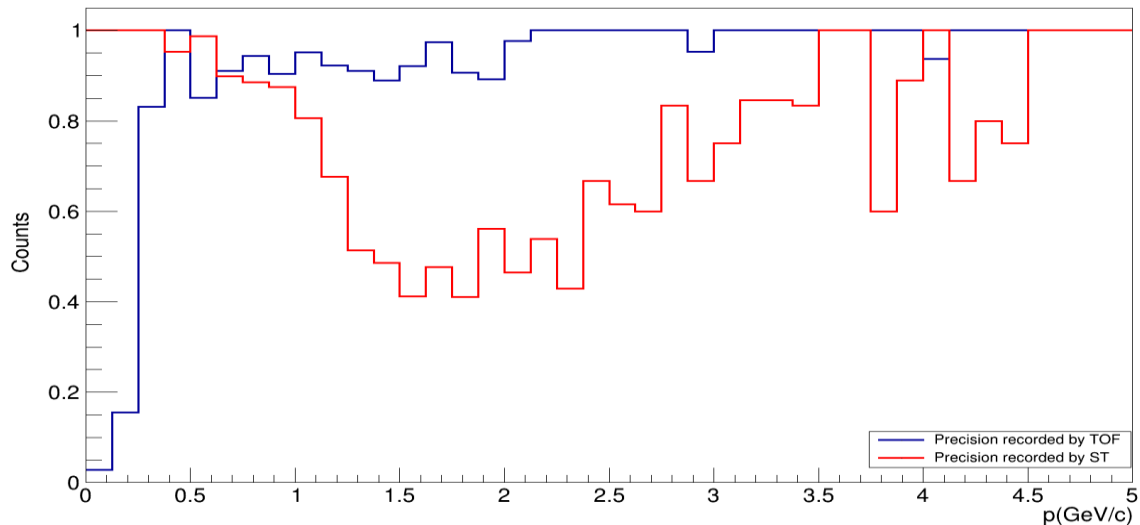

- Here, protons and antiprotons were considered together, but the fraction of produced antiprotons is negligible.
- It can be seen dE/dx measurements alone will not allow precise determination of proton spectrum. The reasonably good results can be expected only in case of combined identification by ionization losses and TOF system.

Detector Level Proton Momentum Spectra for Ca-Ca

Charged Particles Identified as Protons by ST, Ca40-Ca40

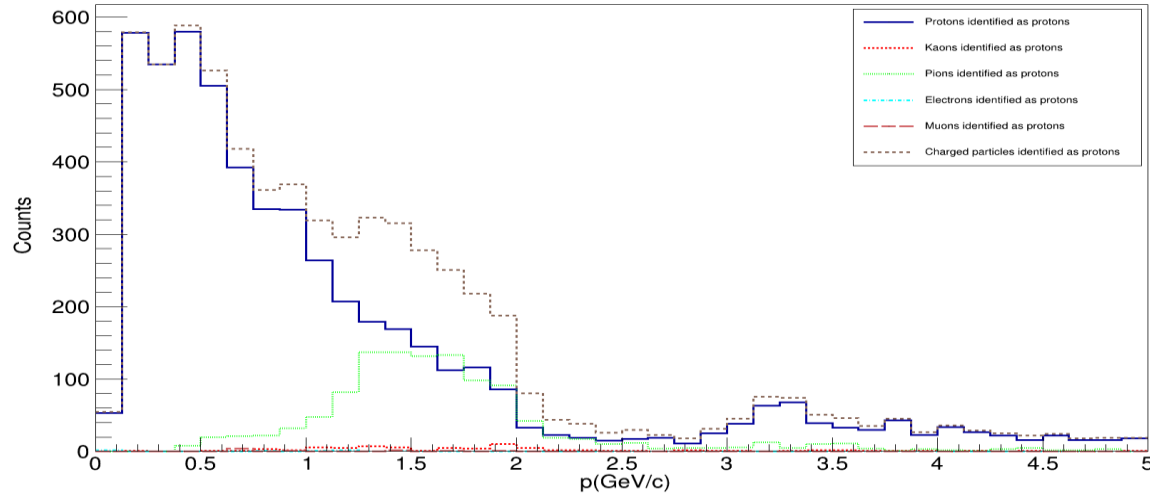

Charged Particles Identified as Protons by TOF, Ca40-Ca40

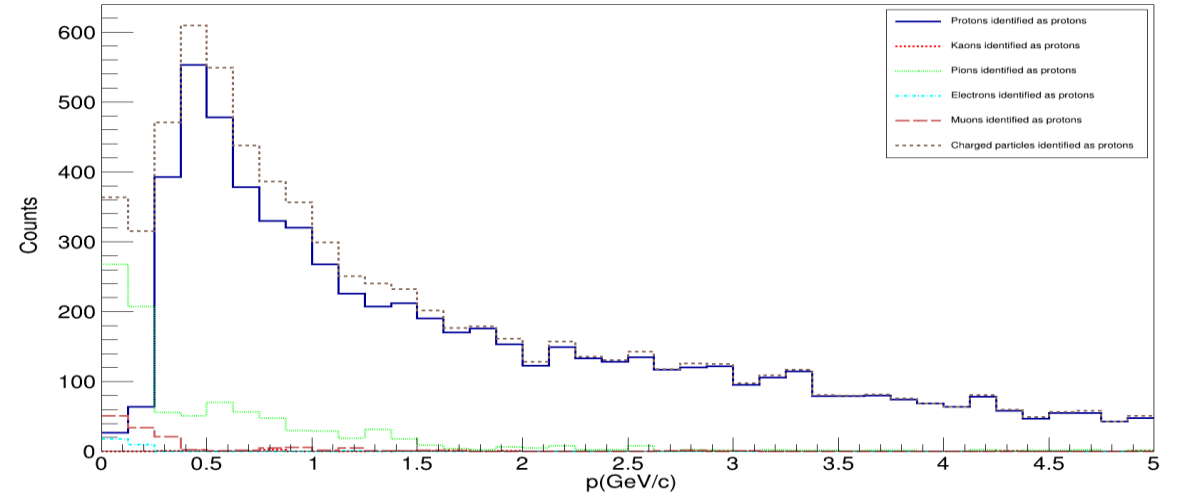

Proton spectra precision, Ca40-Ca40

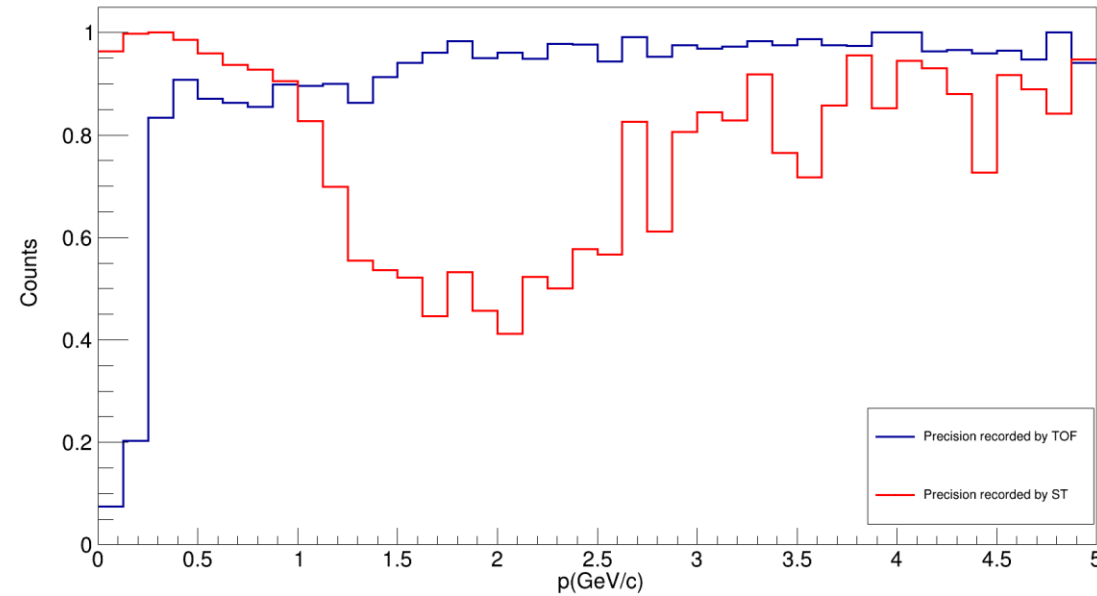

Conclusion and future development:

- Part of the events with high number of charged tracks may not be fully reconstructed.
- Particle identification with ionization losses and TOF was considered separately (for future dE/dx only or their combination can be expected).
- The purity of the measured charged pion distribution for both types of ion collisions using dE/dx only is rather good and meets mentioned before requirements.
- In case of combination of information from ionization losses and time of flight system purity of proton distribution may be improved.

References

- [1] V. M. Abazov et al. [SPD proto], [arXiv:2102.00442 [hep-ex]]
- [2] SPD TDR [unpublished]

Thankyou for your kind attention!