

Mössbauer spectrometer with intelligent modulation of gamma ray energy



PALACKÝ
UNIVERSITY
OLOMOUC

Author: Mgr. Pavel Kohout

Supervisor: Doc. RNDr. Jiří Pechoušek, Ph.D.

Consultant: Prof. RNDr. Miroslav Mašláň CSc.

Outline

- Mössbauer spectrometer based on RIO platform
- Linearization of Mössbauer spectra
- Conclusion

Mössbauer spectrometer based on RIO platform

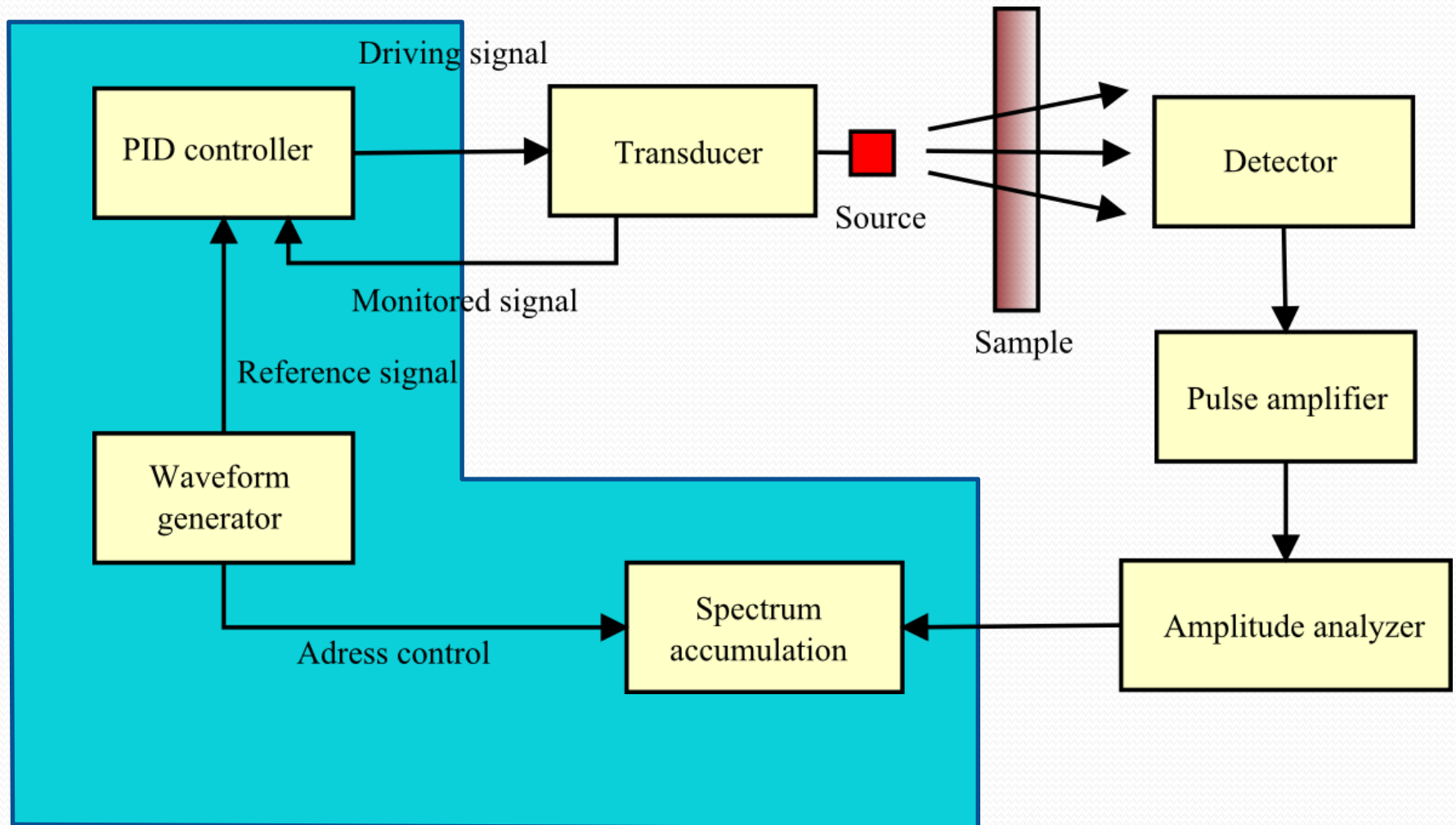

Mössbauer spectrometer based on RIO platform

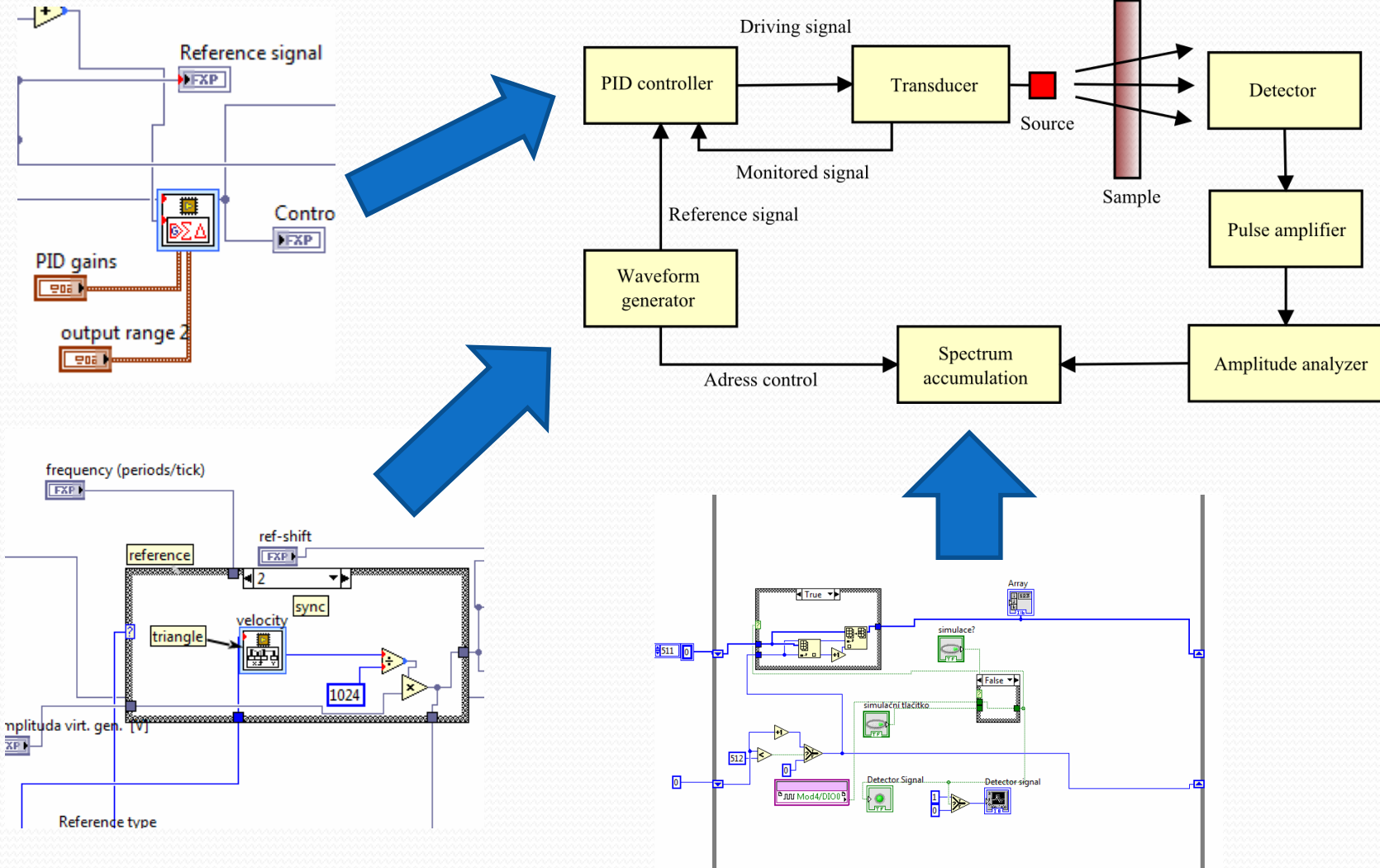

Mössbauer spectrometer based on RIO platform

- Velocity signal generation, PID regulation and spectra registration on single chip - FPGA (Field Programmable Gate Array)

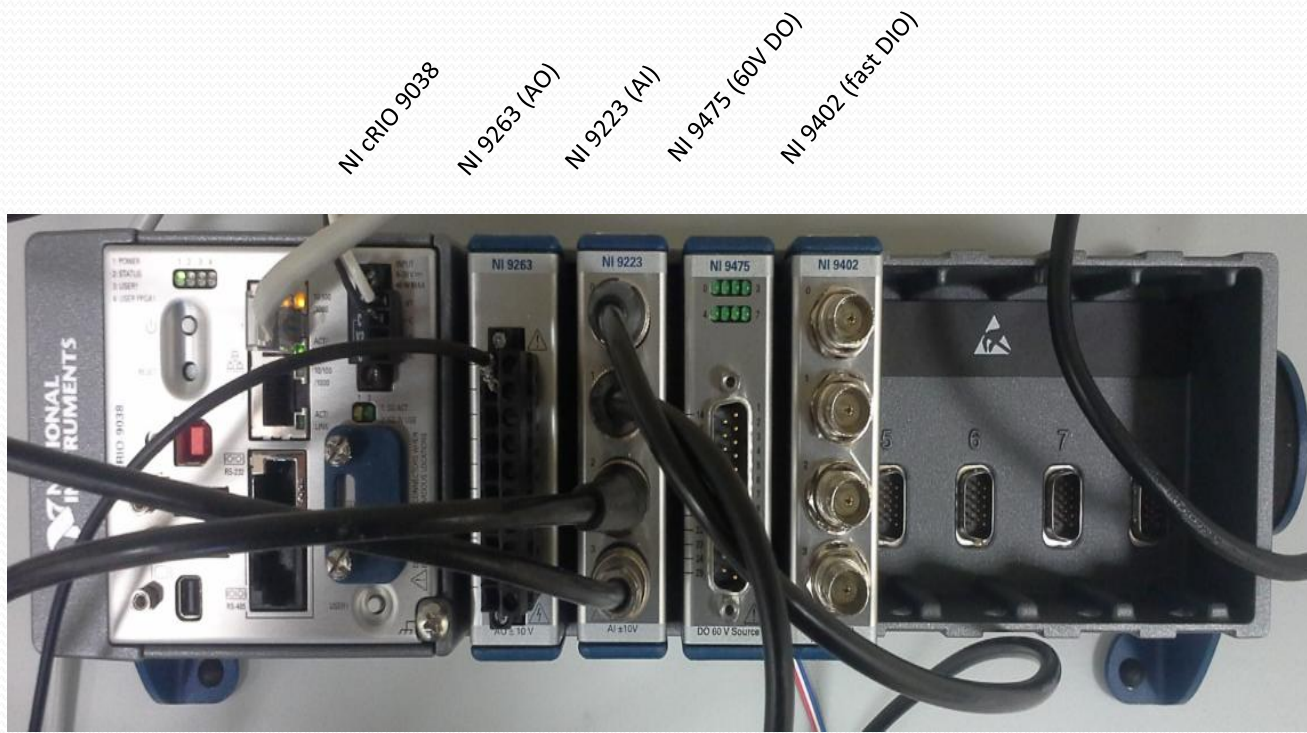

Mössbauer spectrometer based on RIO platform

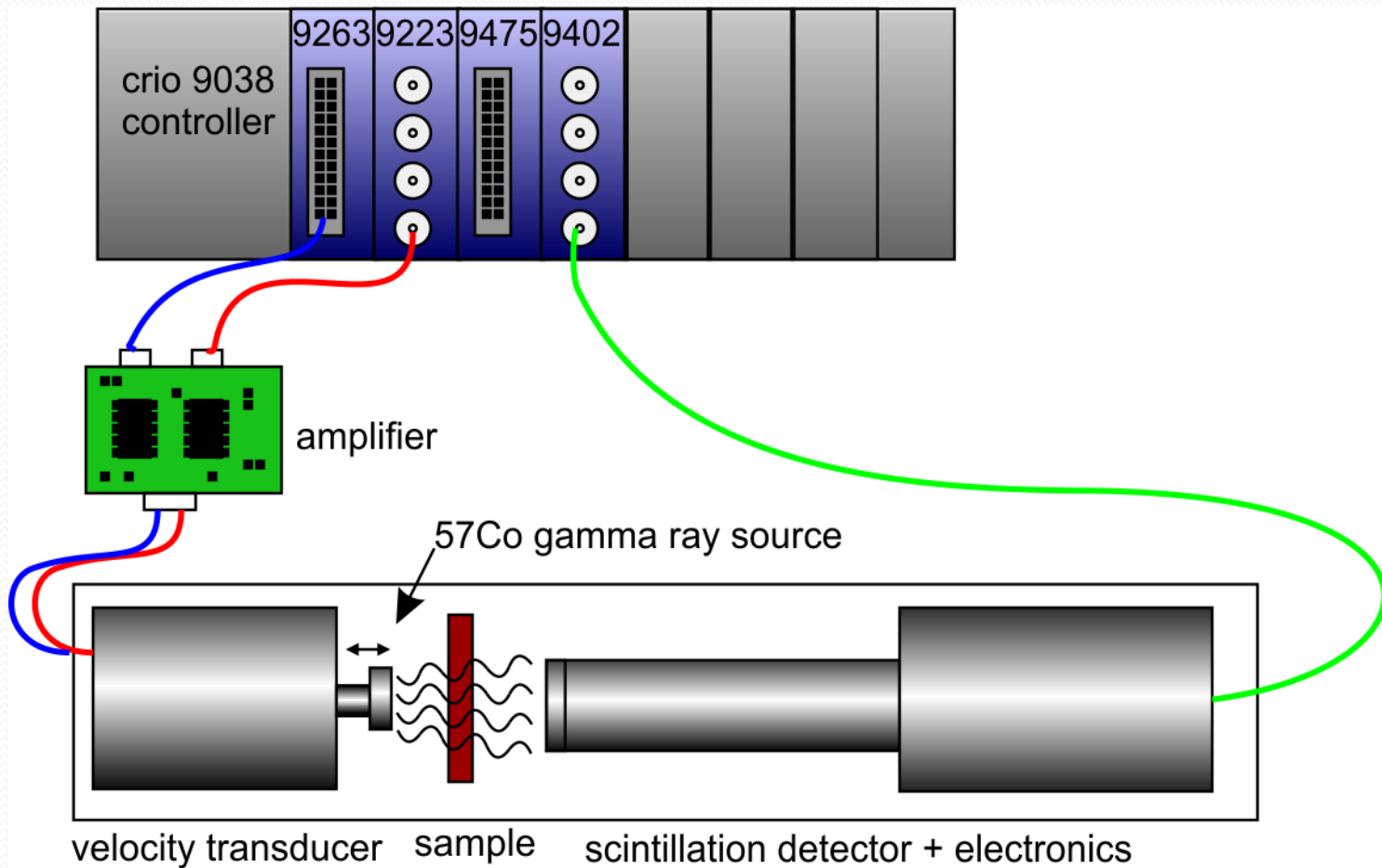

Detection

- Single channel analyzer
- Data acquisition using fast digital input

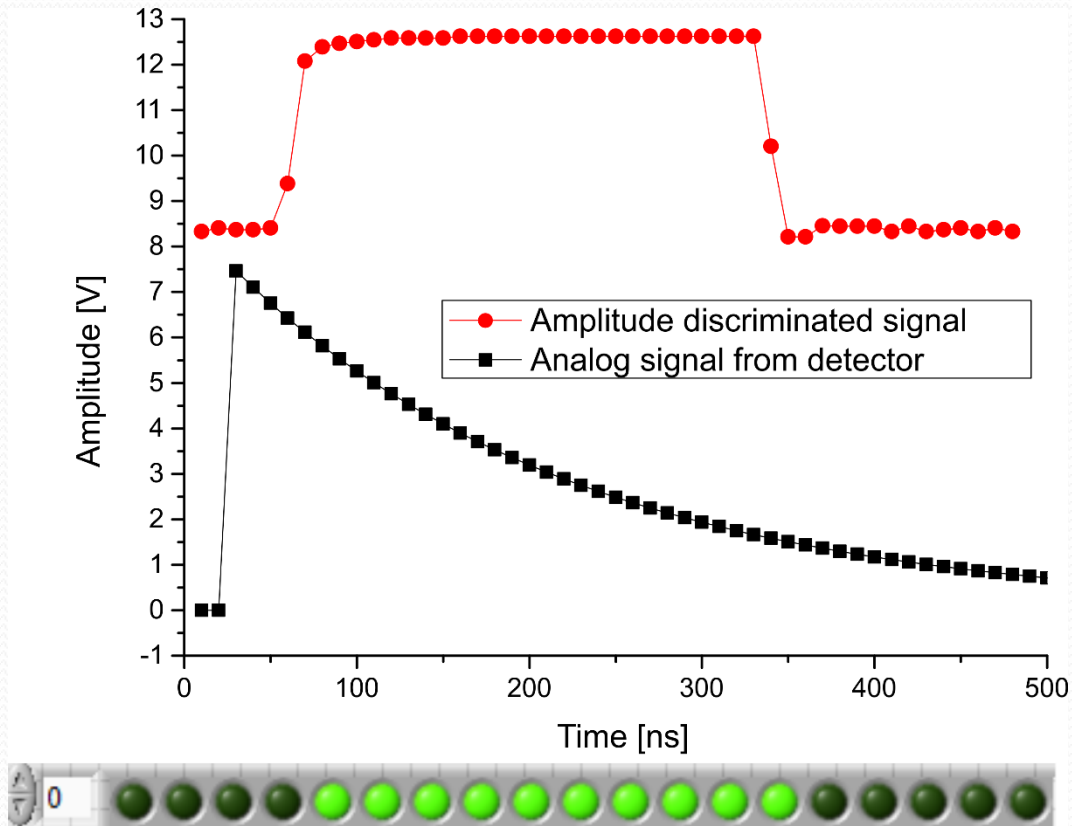

Velocity driving system

- Virtual velocity generator
- Double PID regulator (one for velocity, second for drift)
- Automatic PID parameters tuning using genetic algorithms

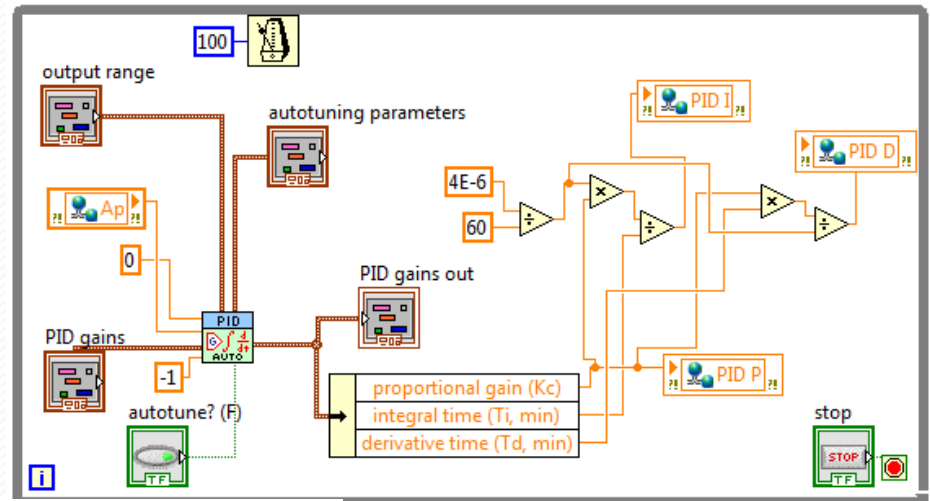

$$u(t) = k_R \left[e(t) + \frac{1}{T_I} \int_0^t e(\tau) d\tau + T_D \frac{de(t)}{dt} \right]$$

$$u(kT) = k_R \left\{ e(kT) + \frac{T}{T_I} \sum_{i=1}^k e(iT) + \frac{T_D}{T} \{ e(kT) - e[(k-1)T] \} \right\} + u(0)$$

Sine velocity recalculation

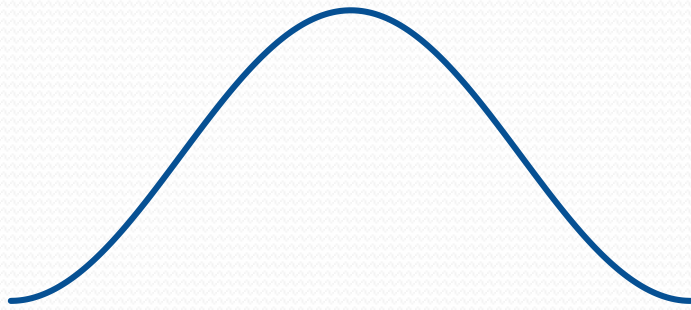

sine

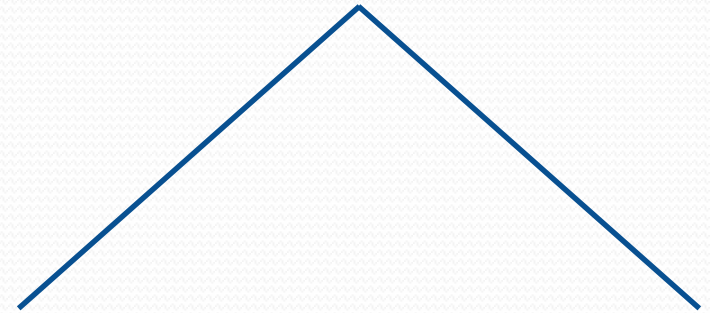
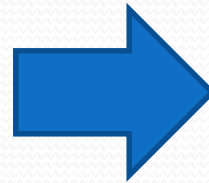

recalculated triangle

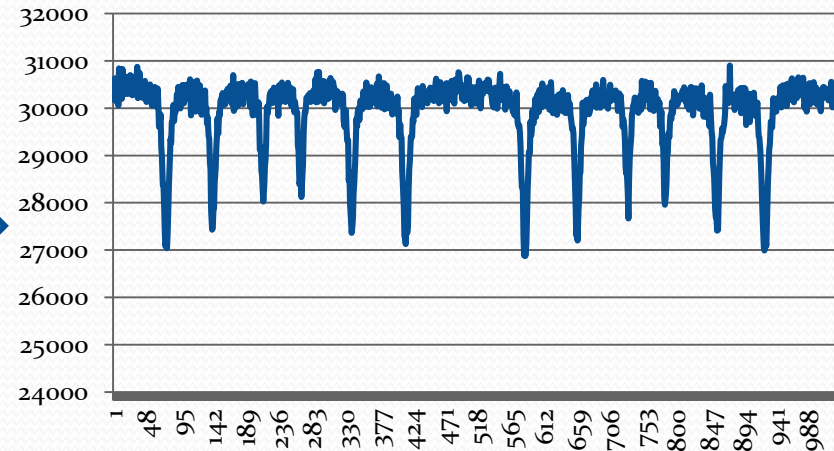
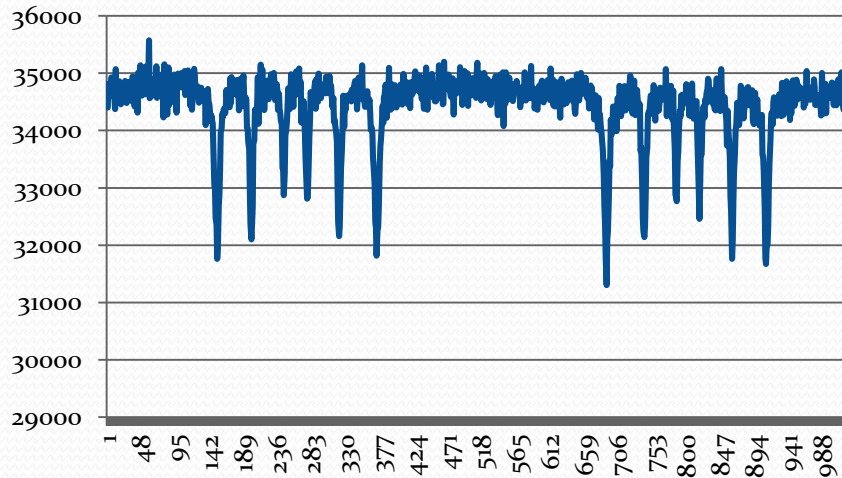
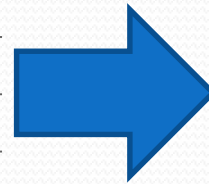

Comparison with traditional MS using triangular velocity signal

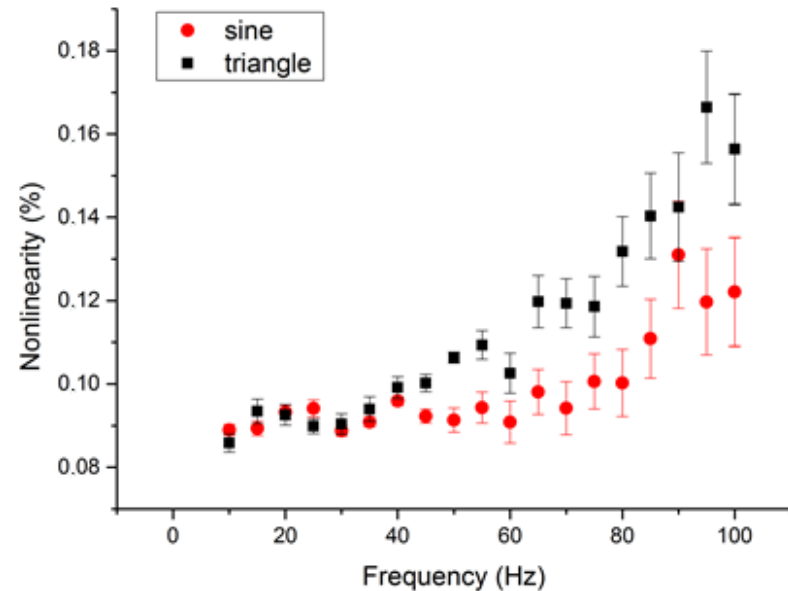
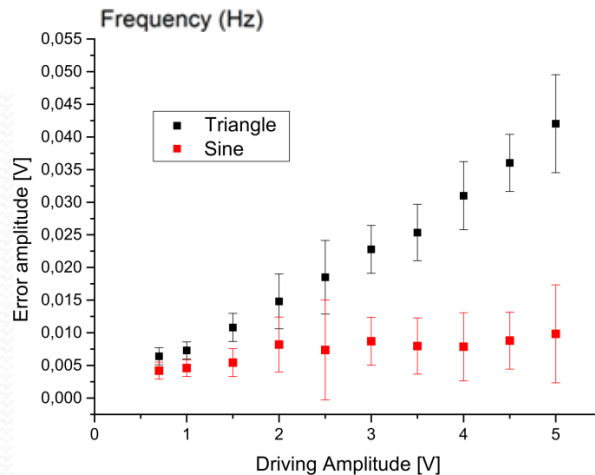
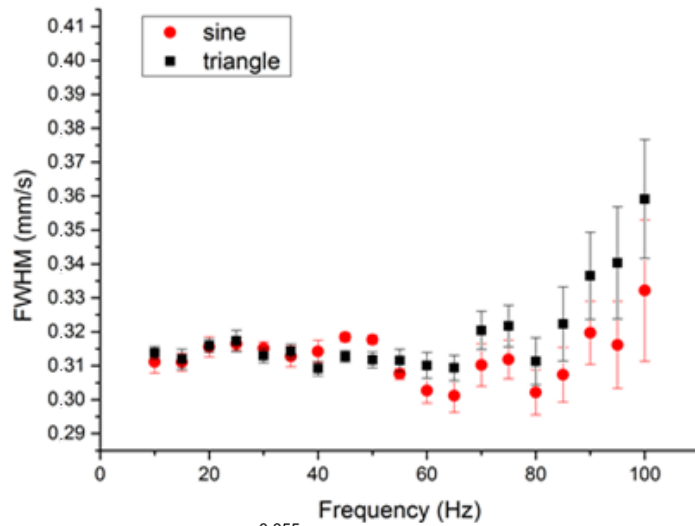

Advantages of sine velocity signal

- Higher frequency stability
- Higher amplitude stability
- Useful for piezoelectric transducers

Laser system Keyence LKG-5000

- Linearity of velocity axis measured with laser vibrometer
- Useful for measuring the piezoelectric transducers
- Recalculation of spectra using inverse function of measured velocity



source: keyence.co.jp

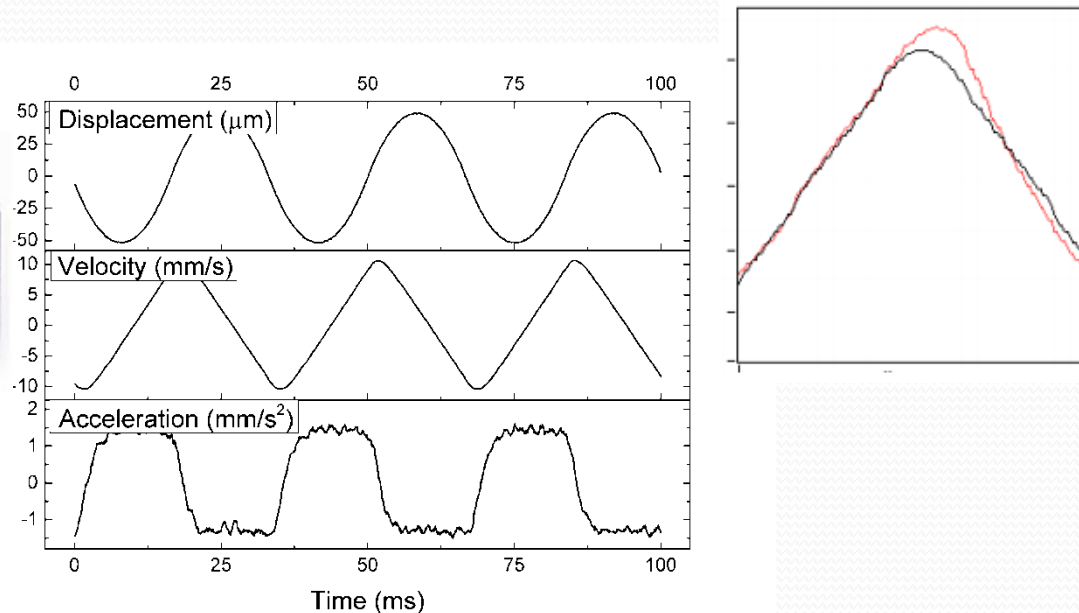

Conclusion

- Mössbauer spectrometer based on RIO platform
- Programmed on FPGA
- DAQ using DI/O and amplitude discriminator
- Automatic tuning of PID parameters
- Spectra with sine velocity axis and their linearization
- Better frequency and amplitude stability

See also

Linearization:

- Pavel Kohout, Tomas Frank, Jiří Pechoušek a Lukáš Kouřil. (2018). Mössbauer spectra linearity improvement by sine velocity waveform followed by linearization process. *Measurement Science and Technology*, 29(5), 57001. <https://doi.org/10.1088/1361-6501/aaacfo>

PID Controller

- Pavel Kohout, Lukáš Kouřil, Jakub Navařík, Petr Novák, a Jiří Pechoušek, (2014). Optimized linear motor and digital PID controller setup used in Mössbauer spectrometer. *AIP Conference Proceedings*, 501(10). <https://doi.org/10.1063/1.4898610>

Used detector & amplitude discriminator:

- Navařík, J., Novák, P., Pechoušek, J., Machala, L., Jančík, D., & Maslan, M. (2015). Precise compact system for ionizing radiation detection and signal processing with advanced components integration and electronic control. *Journal of Electrical Engineering*, 66(4), 220–225. <https://doi.org/10.2478/jee-2015-0035>

Used velocity transducer:

- Evdokimov, V. A., Mashlan, M., Zak, D., Fyodorov, A. A., Kholmetskii, A. L., & Misevich, O. V. (1995). Mini and micro transducers for Mössbauer spectroscopy. *Nuclear Inst. and Methods in Physics Research, B*, 95(2), 278–280. [https://doi.org/10.1016/0168-583X\(94\)00611-3](https://doi.org/10.1016/0168-583X(94)00611-3)



Thank you for the attention!

Author thank to internal IGA grant of
Palacký University (IGA_PrF_2018_002)