

# Validation of new devices with pneumatic sensor for measurement and recording of arterial blood pressure

Joanna Kuźma

Department of Cryogenic, Aeronautic and Process Engineering  
Wrocław University of Science and Technology

# Blood pressure measuring methods:

Oscillometric method:



Auscultatory method:



Blood method:

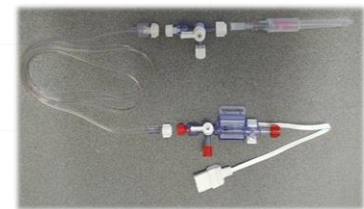
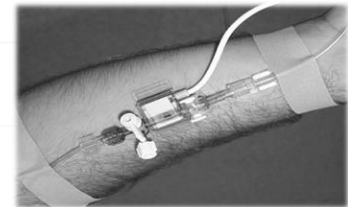

# Our device for blood pressure measurements:

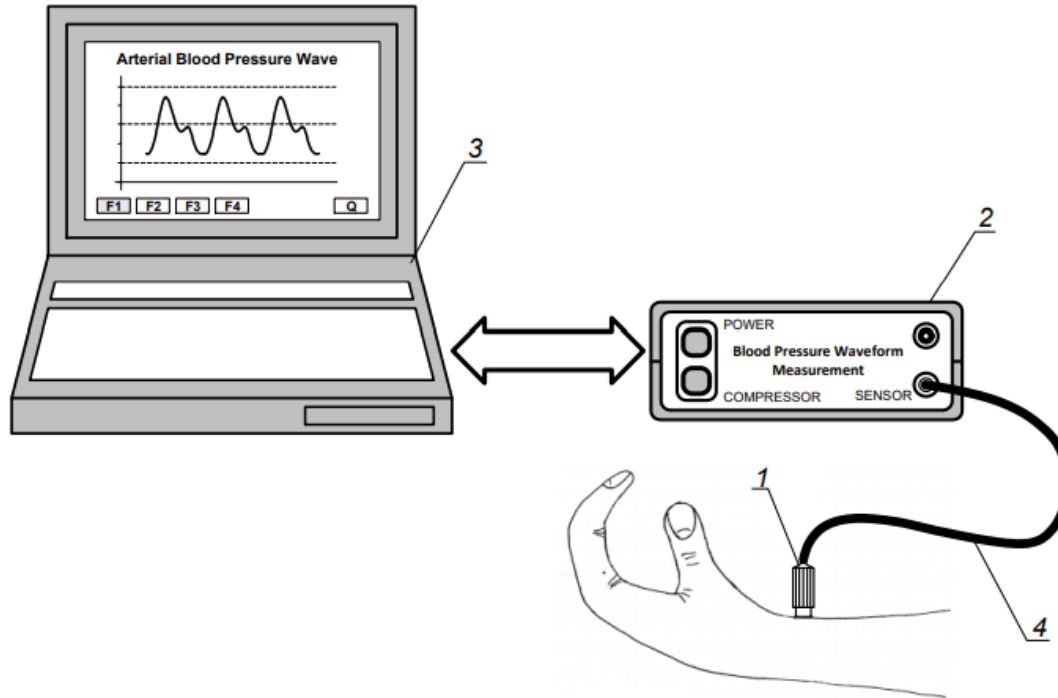

1 – pneumatic sensor, 2 – power/pressure supply, 3 - PC, 4 – pneumatic cable

# Sensor design:

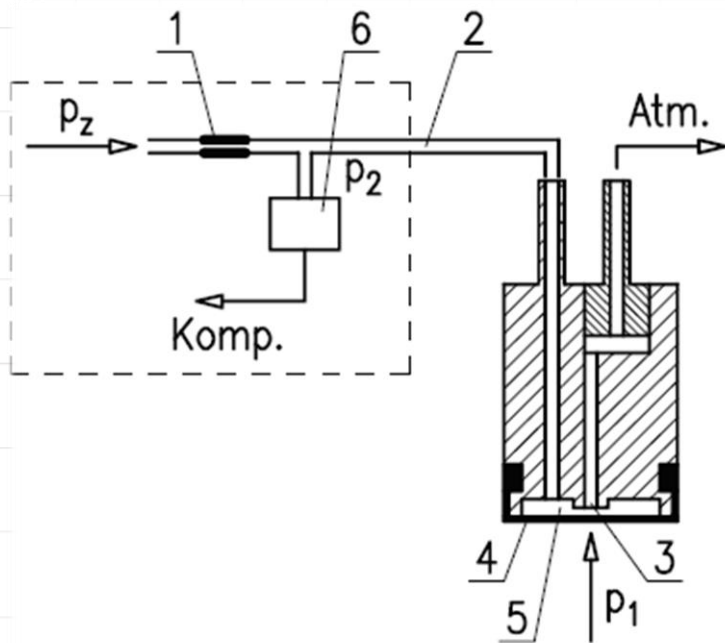

- 1 - flow restrictor
- 2 - elastic tube
- 3 - air outlet
- 4 - membrane
- 5 - measurement chamber
- 6 - pressure-to-voltage signal converter

# Computer interface:

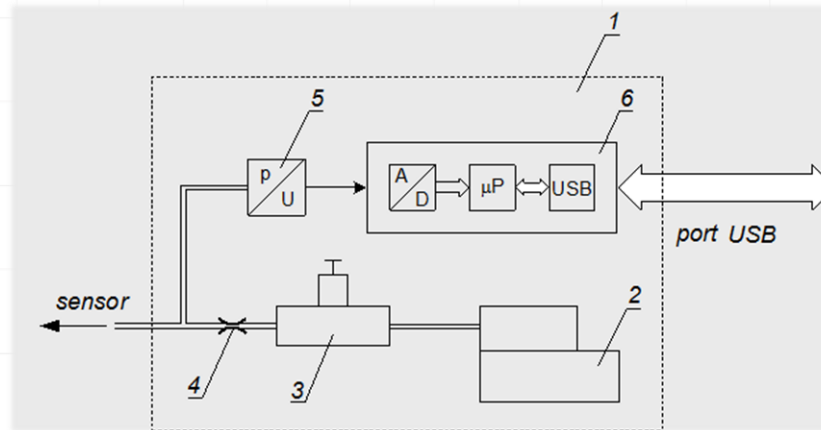

- 1 – Computer interface
- 2 – air micro compressor
- 3 – pressure stabilizer
- 4 – flow restrictor
- 5 – pressure-to-voltage signal converter
- 6 – micro controller

# Measurement procedure:

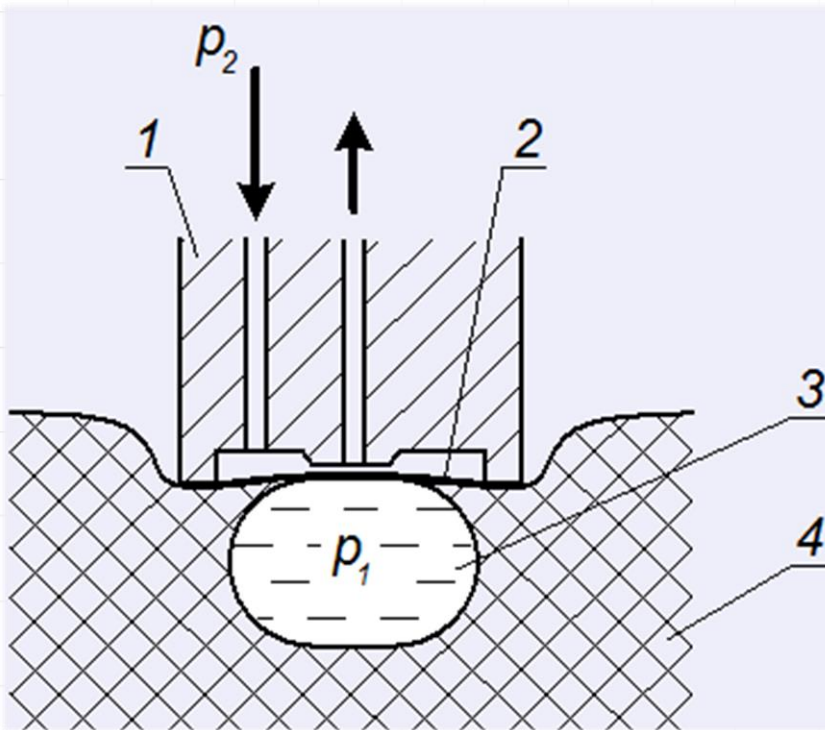

- 1 – sensor
- 2 – membrane
- 3 – artery
- 4 – adipose tissue

# Blood pressure waveform measurements:

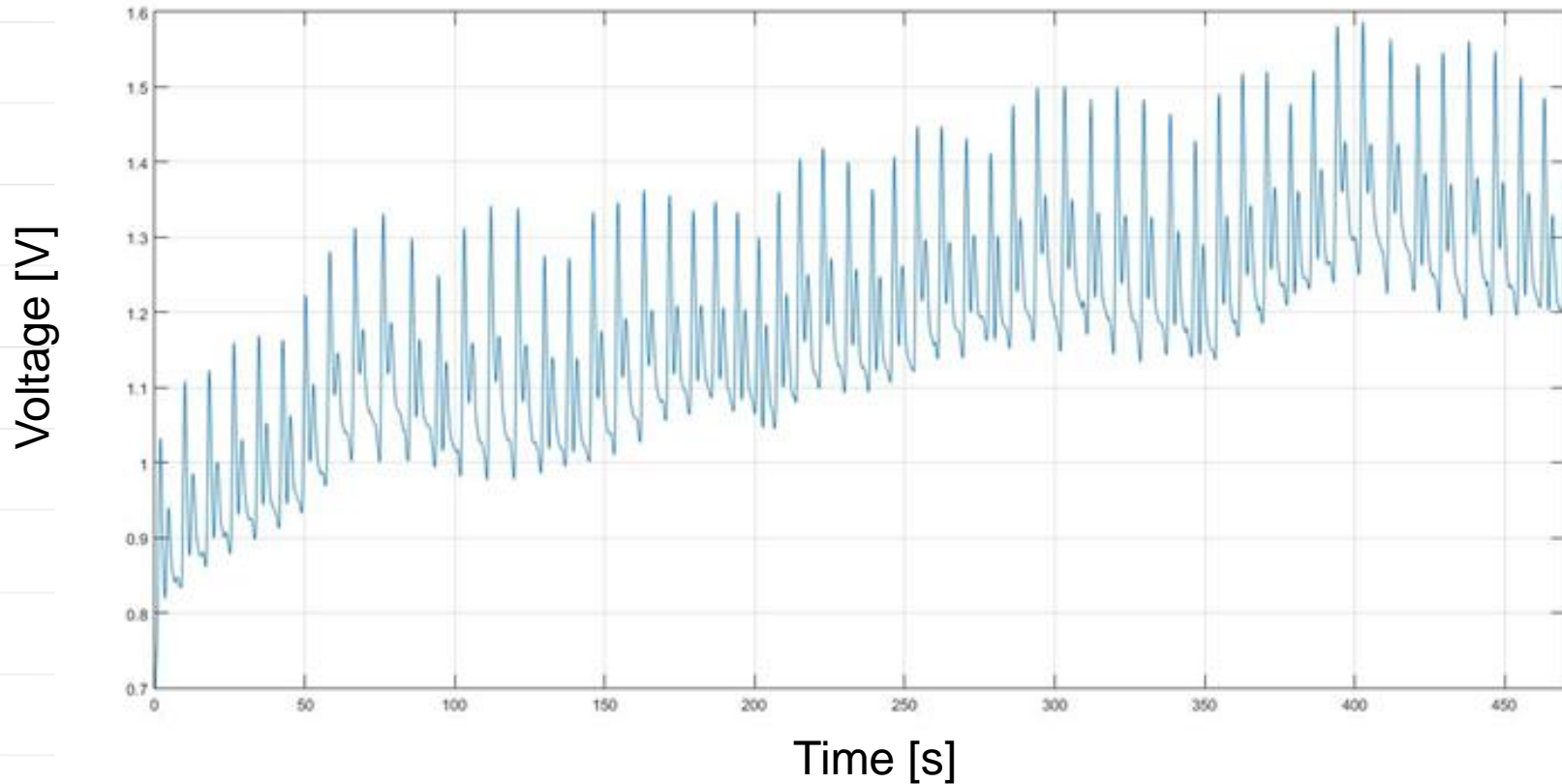

# Locating the maximum peak:

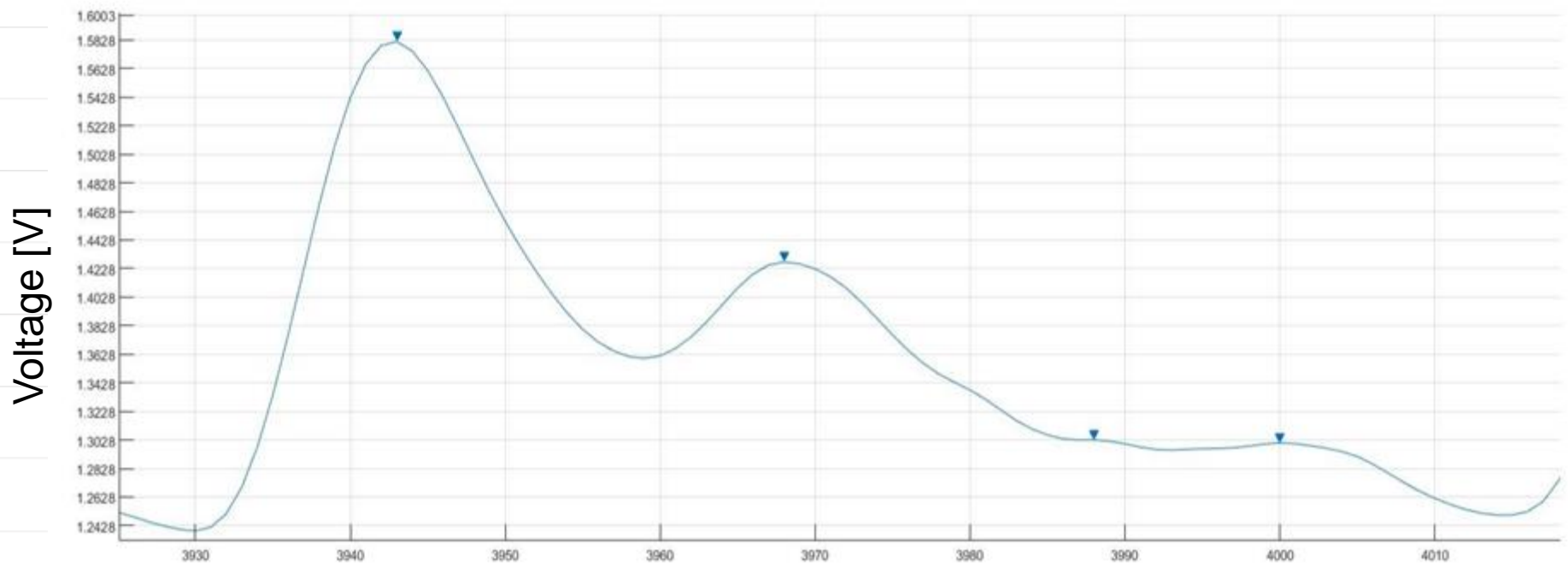



# Systolic pressure measurement error:

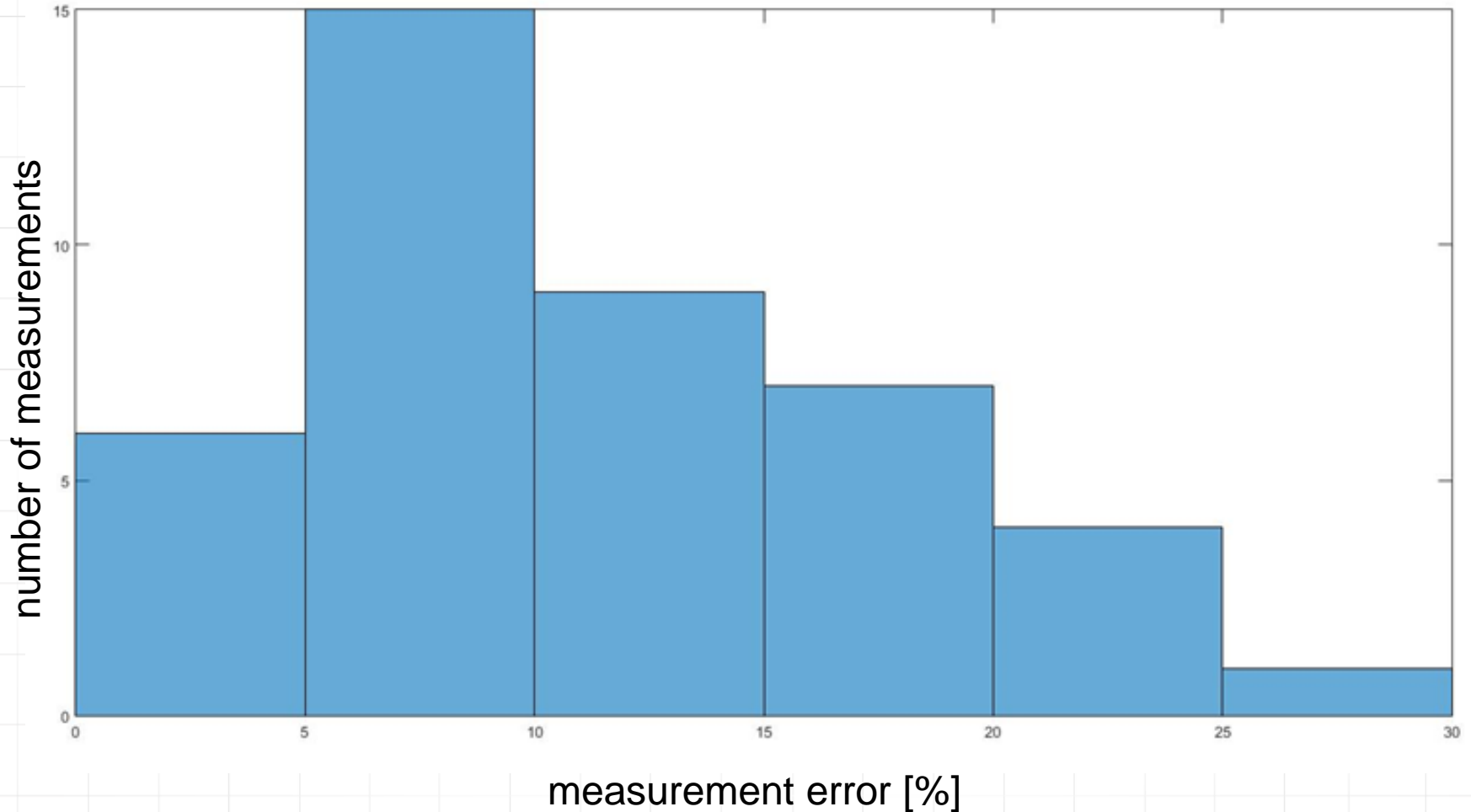

# Diastolic Systolic pressure measurement error:

•  
•

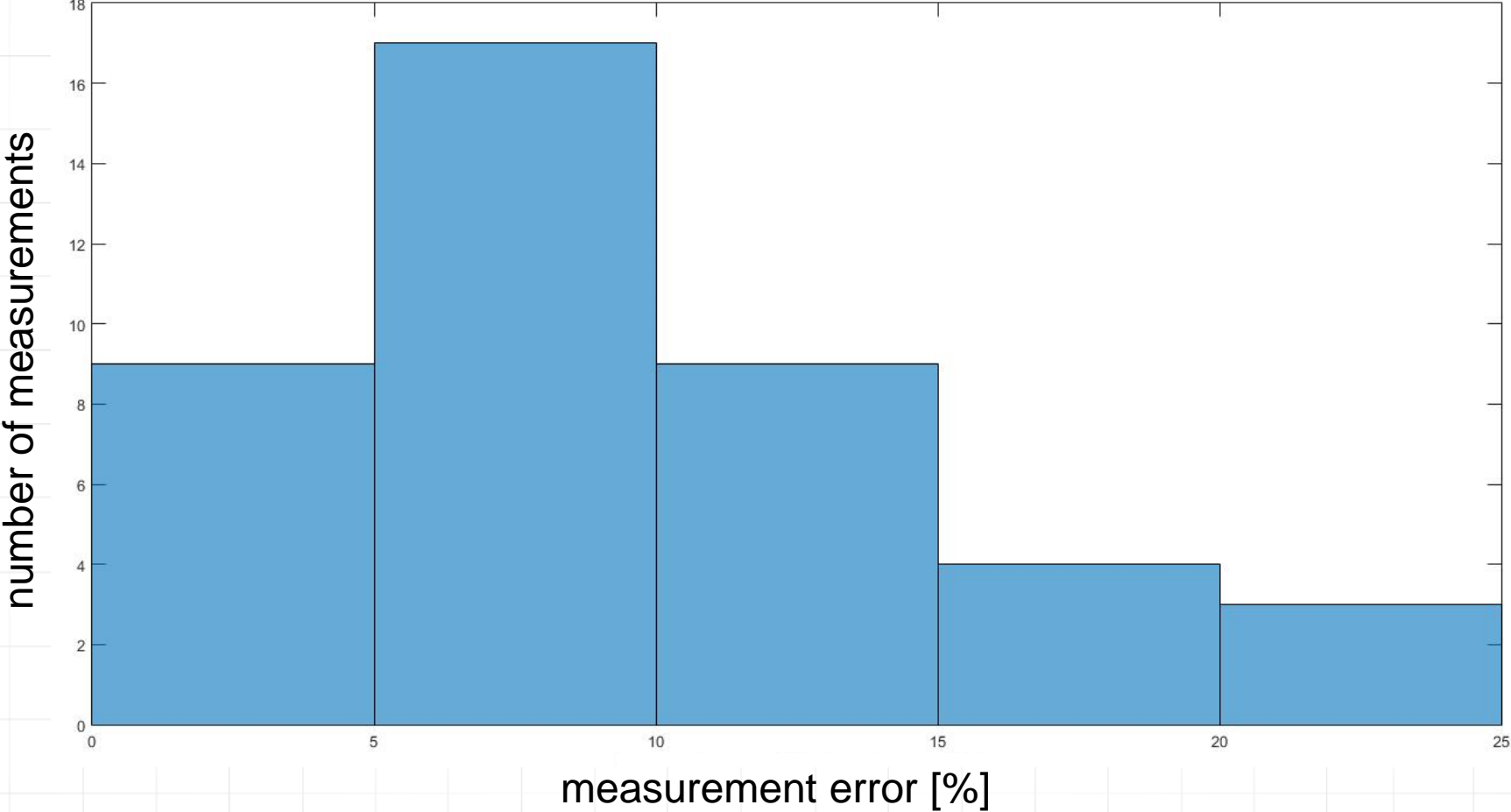

# Summary:

- the device can register blood pressure waves
- the device is not very accurate
- to improve the results, some modifications should be made

# Thank you for your attention