

# Sampo&G4 meeting

14/04/25

# Bridge and Adapter

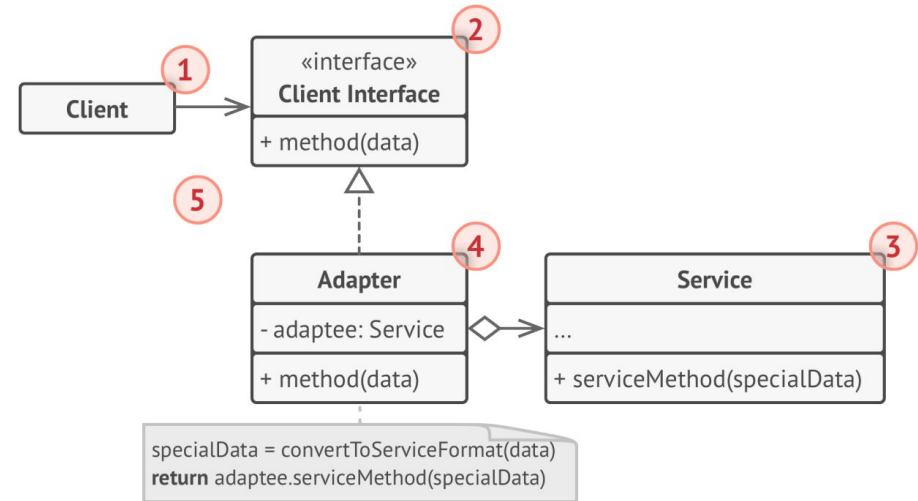
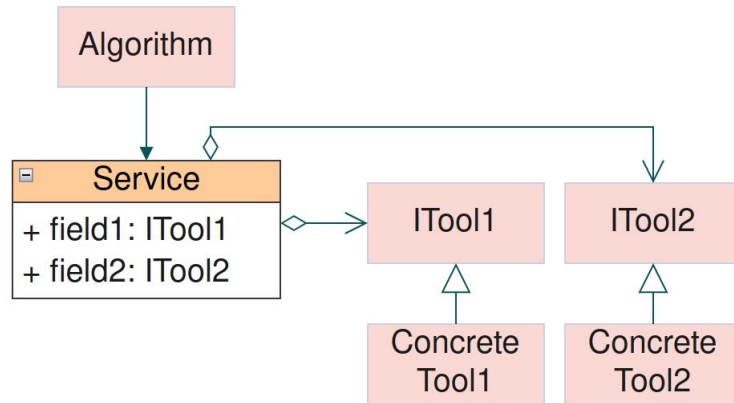

# Physics List

2 Types of options:

- Register
- Replace

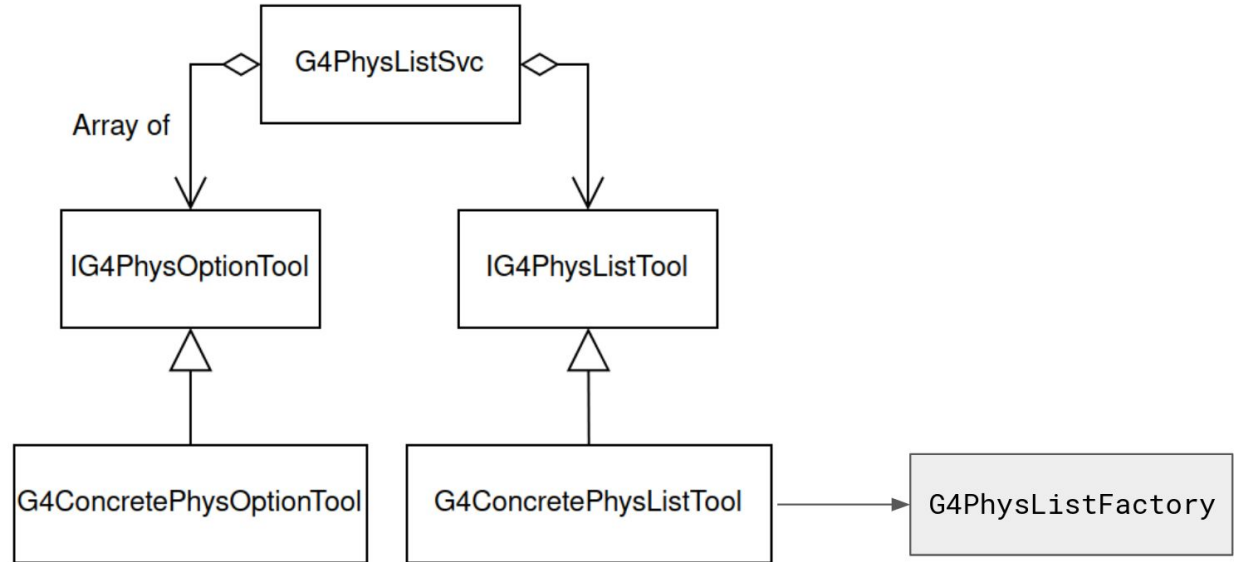

# Detector Construction

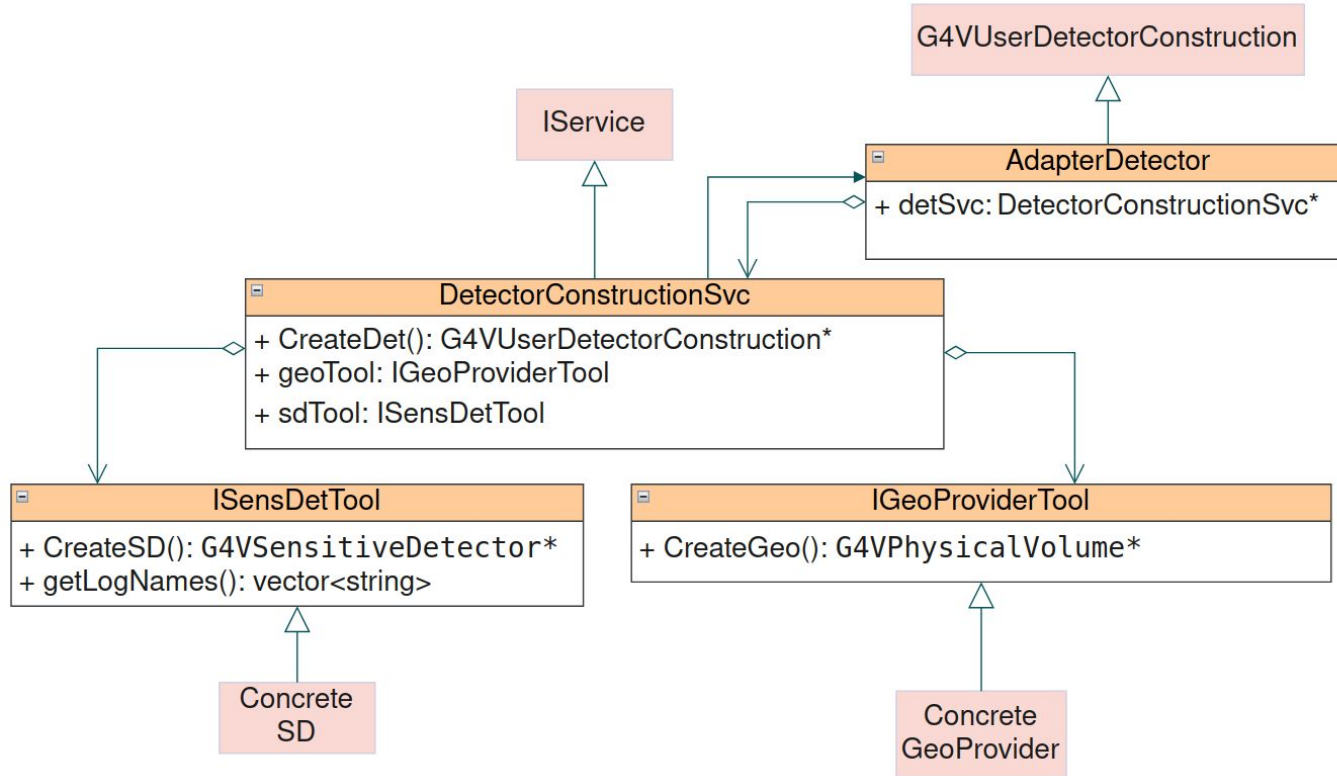

# Action Initialization

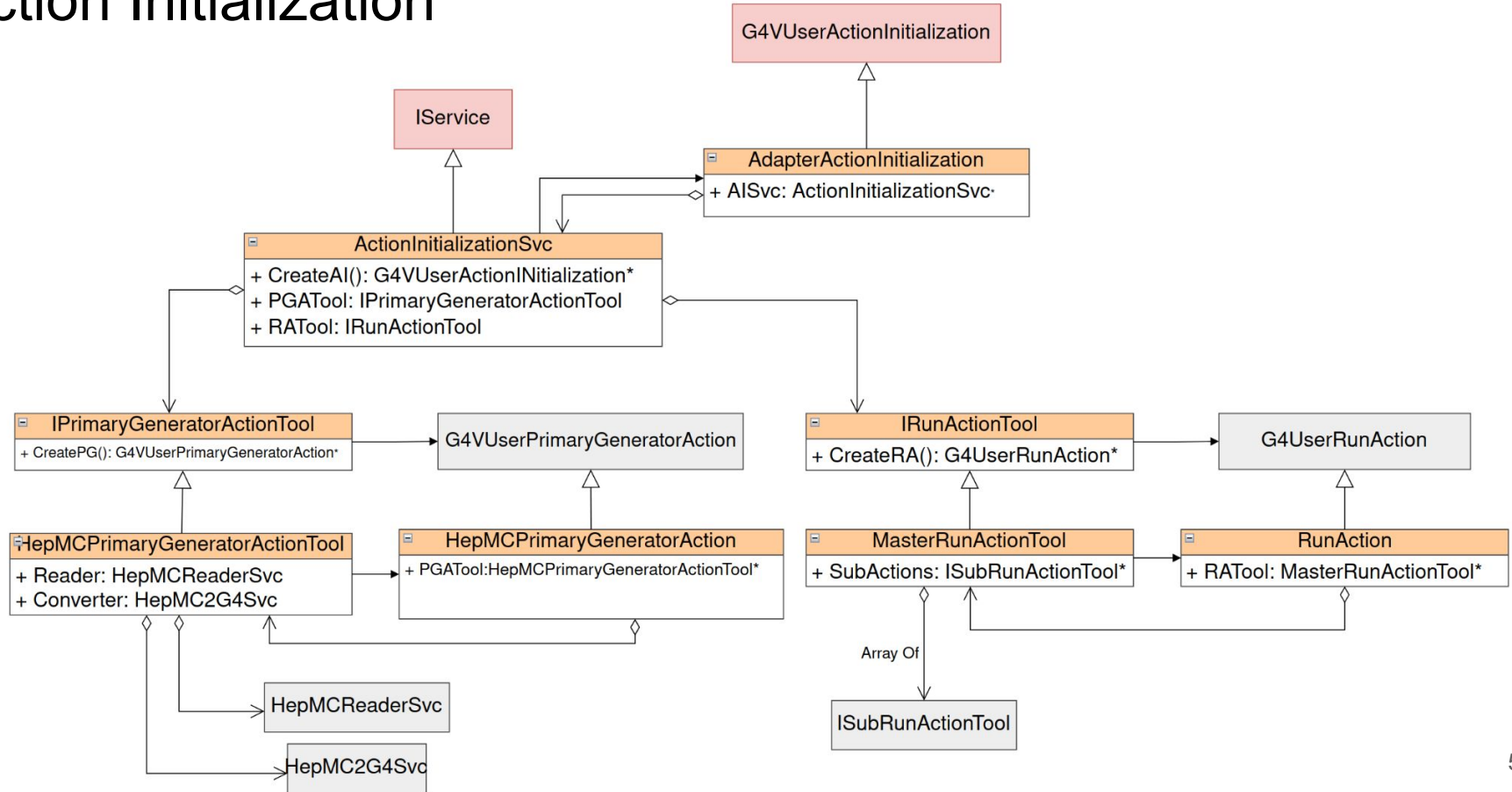

# HepMC3: Reader and Writer

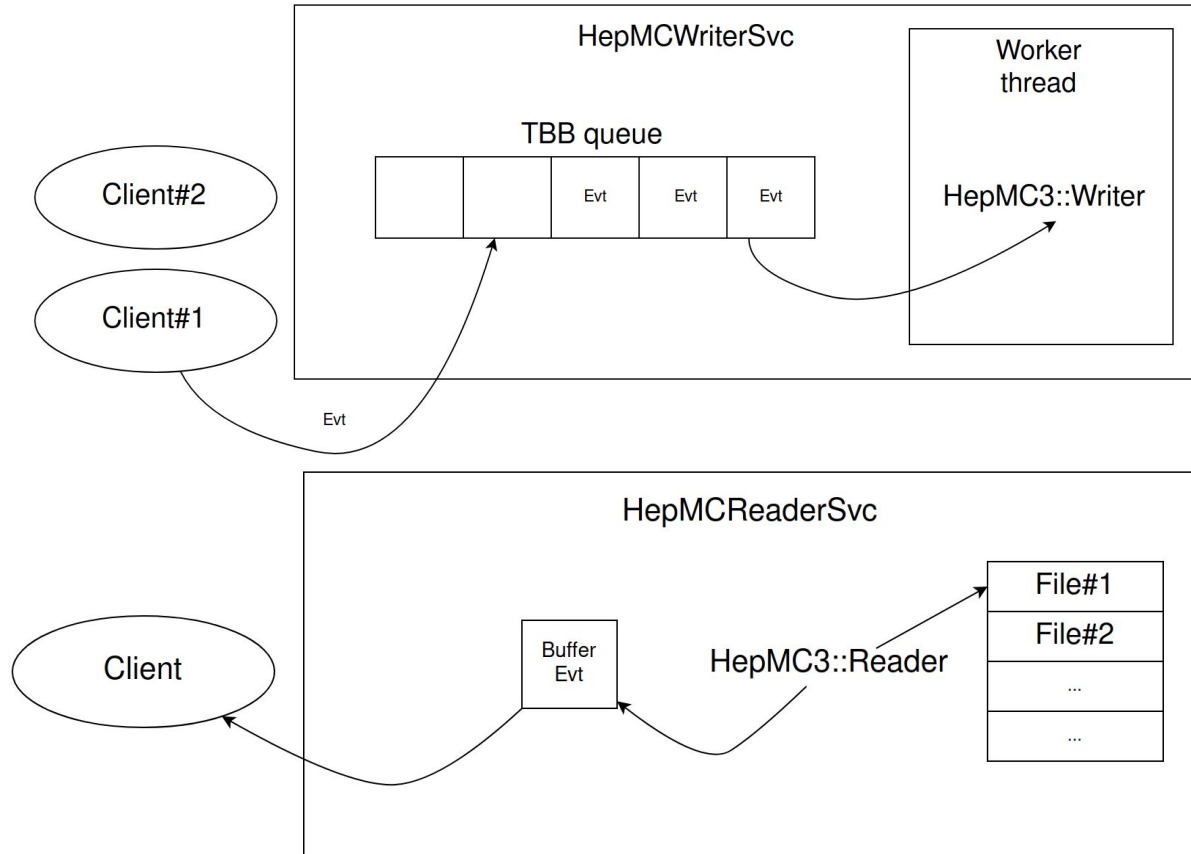

Reader  
schedules  
EventLoop  
stop after last  
evt read

# HepMC3 to G4 conversion: strategies

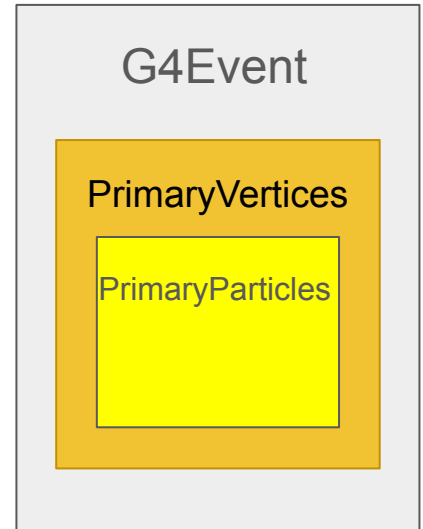
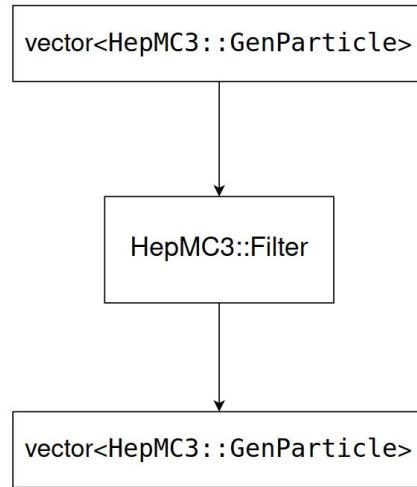
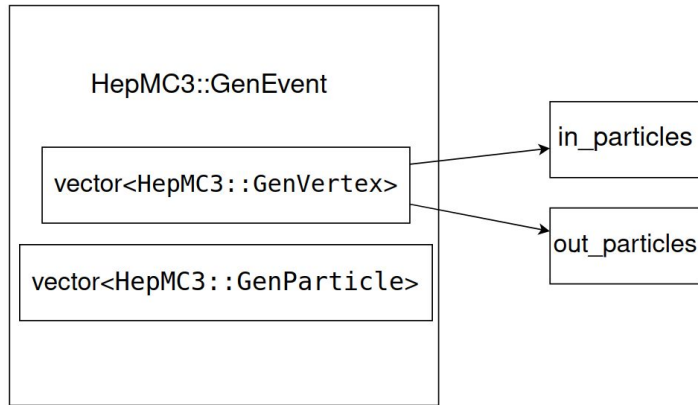

# Things to discuss

- HepMC3 event filtering and conversion
- Hits format, production and storage