

# HEAVY BARYON SPECTROSCOPY

Rudolf Faustov

Institute of Cybernetics and Informatics in Education, FRC CSC RAS, Moscow

(in collaboration with Dietmar Ebert and Vladimir Galkin)

- D. Ebert, R. N. Faustov and V. O. Galkin, “Masses of excited heavy baryons in the relativistic quark model,” Phys. Lett. B **659**, 612 (2008) [arXiv:0705.2957 [hep-ph]]
- D. Ebert, R. N. Faustov and V. O. Galkin, “Spectroscopy and Regge trajectories of heavy baryons in the relativistic quark-diquark picture,” Phys. Rev. D **84**, 014025 (2011) [arXiv:1105.0583 [hep-ph]]
- D. Ebert, R. N. Faustov, V. O. Galkin and A. P. Martynenko, “Mass spectra of doubly heavy baryons in the relativistic quark model,” Phys. Rev. D **66**, 014008 (2002) [hep-ph/0201217].

Helmholtz International Summer School

”Quantum Field Theories at the limits: From Strong Fields to Heavy Quarks”

22.07.-02.08.2019, Dubna, Russia

## INTRODUCTION

- R. Aaij *et al.* [LHCb Collaboration], “Study of the  $D^0 p$  amplitude in  $\Lambda_b^0 \rightarrow D^0 p \pi^-$  decays,” arXiv:1701.07873 [hep-ex].

An amplitude analysis of the decay  $\Lambda_b^0 \rightarrow D^0 p \pi^-$  was performed in the region of the phase space containing  $D^0 p$  resonant contributions.

1.  $\Lambda_c(2880)^+$ : preferred spin –  $J = 5/2$ , with the  $J = 7/2$  hypothesis disfavoured by 4.0 standard deviations. The solutions with  $J = 1/2$  and  $3/2$  are excluded with a significance of more than 5 standard deviations.

$$m(\Lambda_c(2880)^+) = 2881.75 \pm 0.29(\text{stat}) \pm 0.07(\text{syst})_{-0.20}^{+0.14}(\text{model})\text{MeV},$$

$$\Gamma(\Lambda_c(2880)^+) = 5.43_{-0.71}^{+0.77}(\text{stat}) \pm 0.29(\text{syst})_{-0.00}^{+0.75}(\text{model})\text{MeV}.$$

2.  $\Lambda_c(2860)^+$  (new state): quantum numbers  $J^P = 3/2^+$ , with the parity measured relative to that of the  $\Lambda_c(2880)^+$  state. The other quantum numbers are excluded with a significance of more than 6 standard deviations.

$$m(\Lambda_c(2860)^+) = 2856.1_{-1.7}^{+2.0}(\text{stat}) \pm 0.5(\text{syst})_{-5.6}^{+1.1}(\text{model})\text{MeV},$$

$$\Gamma(\Lambda_c(2860)^+) = 67.6_{-8.1}^{+10.1}(\text{stat}) \pm 1.4(\text{syst})_{-20.0}^{+5.9}(\text{model})\text{MeV}.$$

3.  $\Lambda_c(2940)^+$ : most likely spin-parity assignment is  $J^P = 3/2^-$  but the other solutions with spins  $1/2$  to  $7/2$  cannot be excluded.

$$m(\Lambda_c(2940)^+) = 2944.8_{-2.5}^{+3.5}(\text{stat}) \pm 0.4(\text{syst})_{-4.6}^{+0.1}(\text{model})\text{MeV}.$$

$$\Gamma(\Lambda_c(2940)^+) = 27.7_{-6.0}^{+8.2}(\text{stat}) \pm 0.9(\text{syst})_{-10.4}^{+5.2}\text{MeV}.$$

- R. Aaij *et al.* [LHCb Collaboration], “Observation of five new narrow  $\Omega_c^0$  states decaying to  $\Xi_c^+ K^-$ ,” arXiv:1703.04639 [hep-ex].

Five new, narrow excited  $\Omega_c$  states decaying to  $\Xi_c^+ K^-$  are observed: the  $\Omega_c(3000)^0$ ,  $\Omega_c(3050)^0$ ,  $\Omega_c(3066)^0$ ,  $\Omega_c(3090)^0$ , and  $\Omega_c(3119)^0$ .

Confirmed by Belle arXiv:1711.07927 [hep-ex].

State	Mass (MeV)	Width (MeV)
$\Omega_c(3000)^0$	$3000.4 \pm 0.2 \pm 0.1$	$4.5 \pm 0.6 \pm 0.3$
$\Omega_c(3050)^0$	$3050.2 \pm 0.1 \pm 0.1$	$0.8 \pm 0.2 \pm 0.1$
		$< 1.2$ MeV, 95% CL
$\Omega_c(3066)^0$	$3065.6 \pm 0.1 \pm 0.3$	$3.5 \pm 0.4 \pm 0.2$
$\Omega_c(3090)^0$	$3090.2 \pm 0.3 \pm 0.5$	$8.7 \pm 1.0 \pm 0.8$
$\Omega_c(3119)^0$	$3119.1 \pm 0.3 \pm 0.9$	$1.1 \pm 0.8 \pm 0.4$
		$< 2.6$ MeV, 95% CL

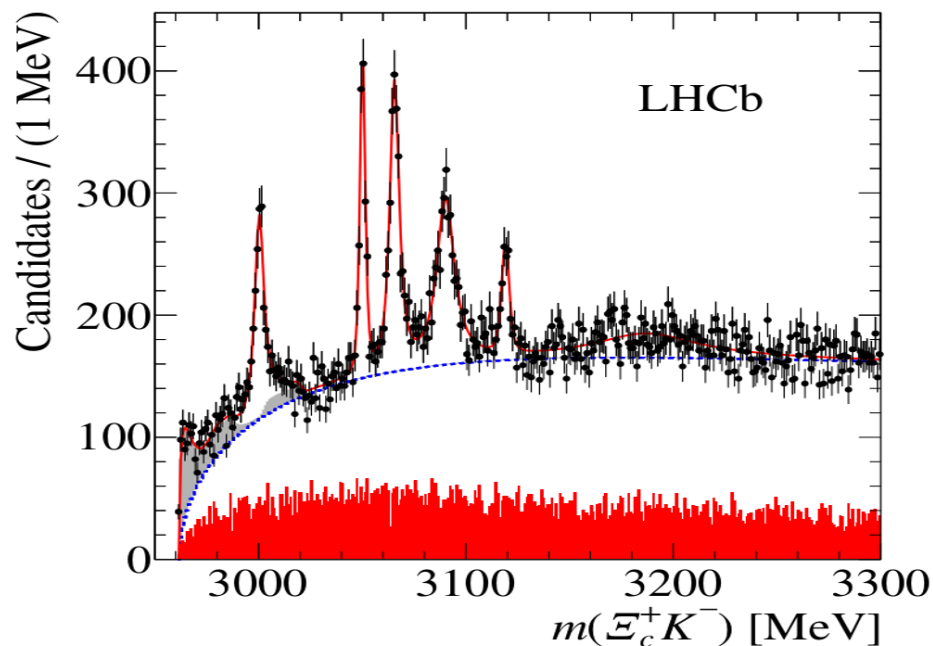

- R. Aaij *et al.* [LHCb Collaboration], “Observation of the doubly charmed baryon  $\Xi_{cc}^{++}$ ,” arXiv:1707.01621 [hep-ex].

Highly significant narrow structure in the  $\Lambda_c^+ K^- \pi^+ \pi^+$  mass spectrum

Consistent with  $\Xi_{cc}^{++}$

$$M(\Xi_{cc}^{++}) = 3621.40 \pm 0.72 \pm 0.27 \pm 0.14 \text{ MeV}$$

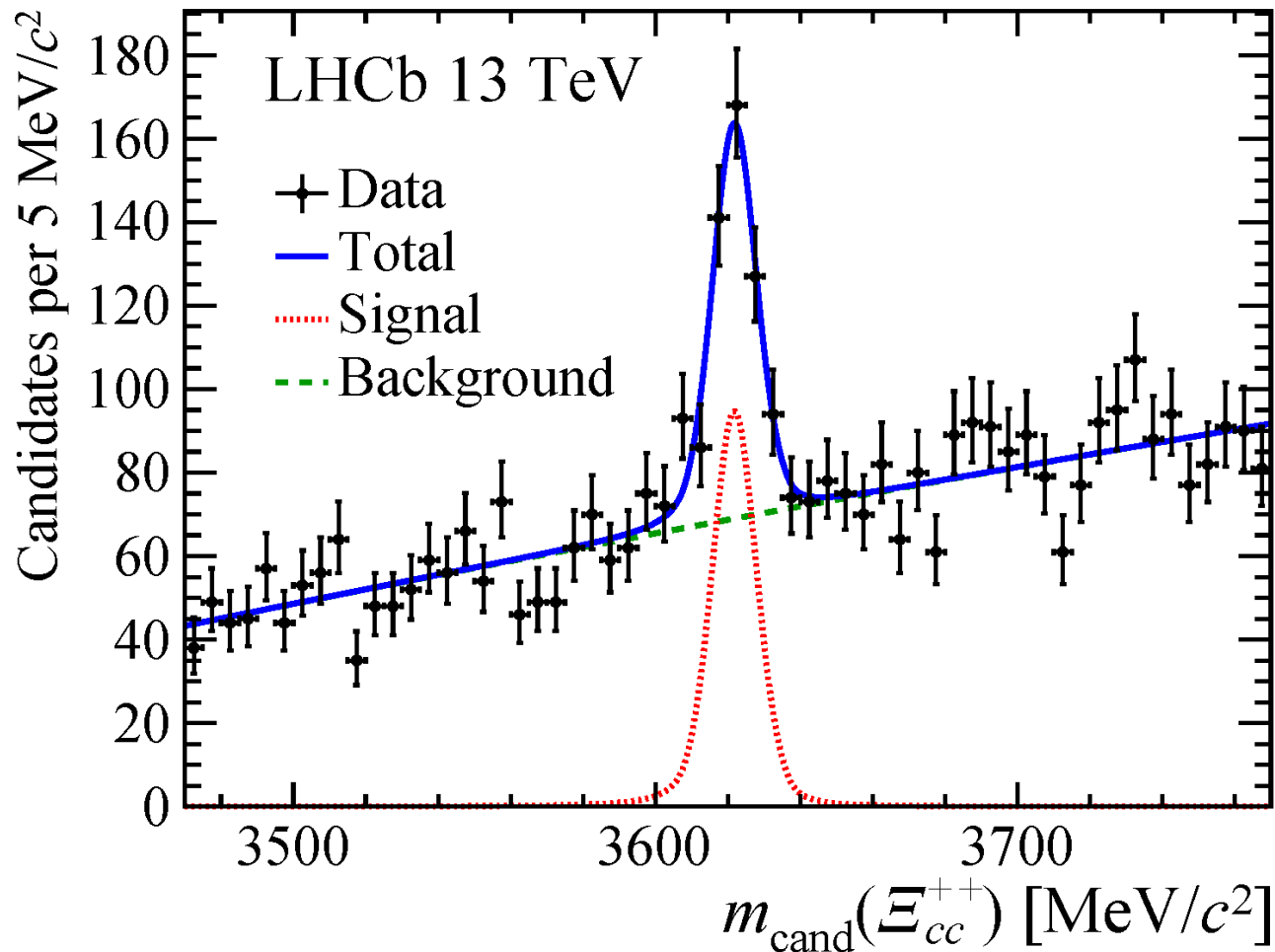

- R. Aaij *et al.* [LHCb Collaboration], “Observation of a new  $\Xi_b^-$  resonance,” arXiv:1805.09418 [hep-ex]. A peak in both the  $\Lambda_b^0 K^-$  and  $\Xi_b^0 \pi^-$  invariant mass spectra is observed:

$$m(\Xi_b(6227)^-) = 6226.9 \pm 2.0 \pm 0.3 \pm 0.2 \text{ MeV},$$

$$\Gamma(\Xi_b(6227)^-) = 18.1 \pm 5.4 \pm 1.8 \text{ MeV}.$$

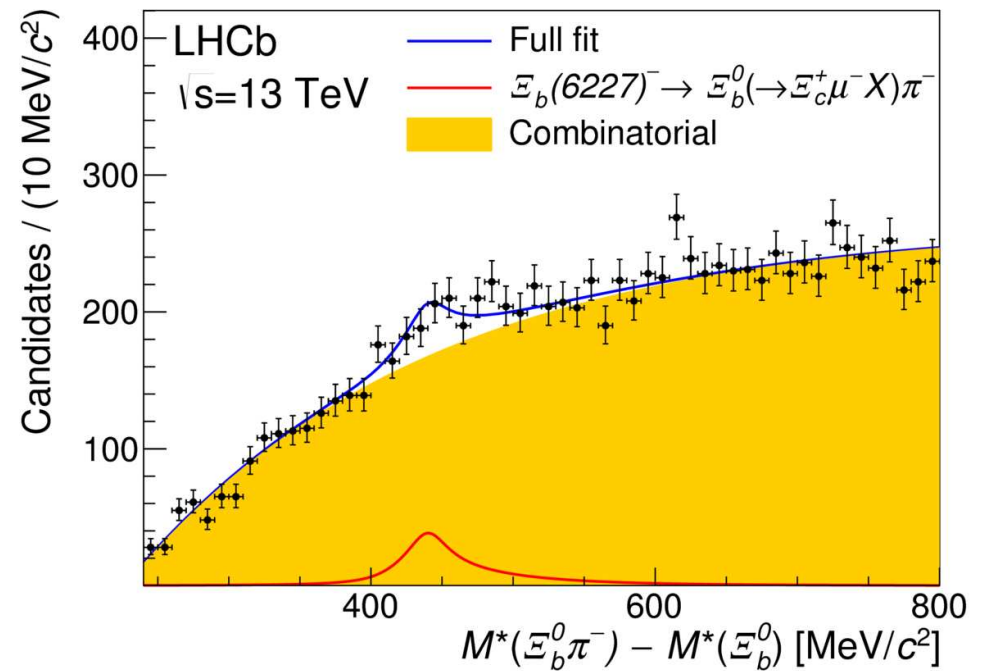
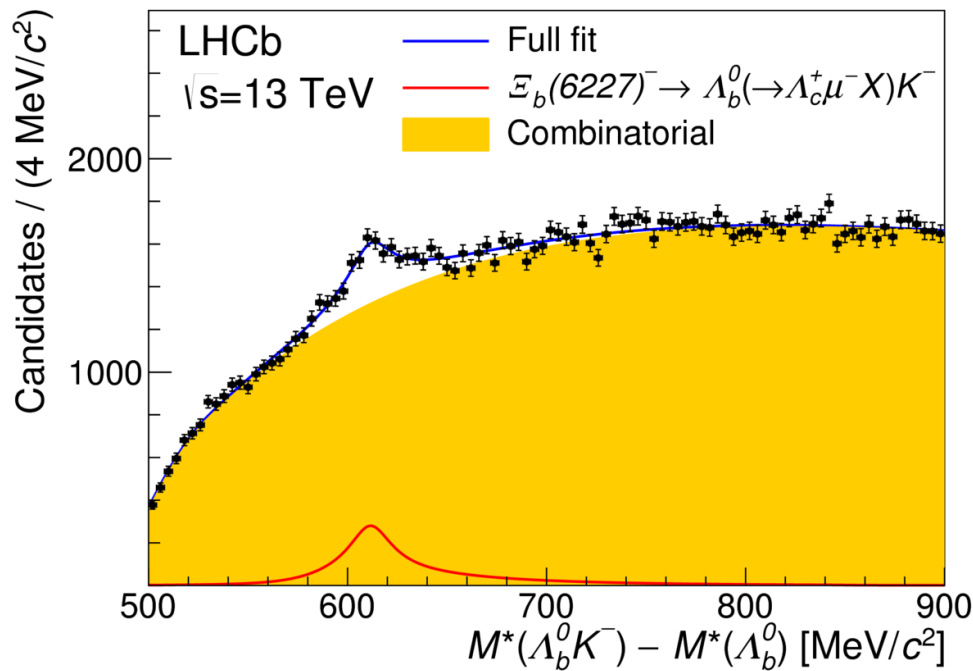

- R. Aaij *et al.* [LHCb Collaboration], “Observation of Two Resonances in the  $\Lambda_b^0 \pi^\pm$  Systems and Precise Measurement of  $\Sigma_b^\pm$  and  $\Sigma_b^{*\pm}$  properties,” arXiv:1809.07752 [hep-ex].

$$m(\Sigma_b(6097)^-) = 6098.0 \pm 1.8 \text{ MeV},$$

$$\Gamma(\Sigma_b(6097)^-) = 29 \pm 4 \text{ MeV}.$$

## Quark–diquark picture of baryons

Convincing evidence of the existence of diquark correlations in hadrons has been collected

- In light meson sector it has been argued for a long time that mesons forming inverted lightest scalar nonet can be well described as tetraquarks treated as diquark-antidiquark bound states
- In heavy meson sector several charged charmonium- and bottomonium-like states were discovered. They should be inevitably multiquark, at least four quark — tetraquark, states. One of the most successful pictures of such tetraquark states is the diquark-antidiquark model
- In baryon sector the number of observed excited states both in light and heavy sectors is considerably lower than the number of excited states predicted in three-quark picture
  - Introduction of diquarks significantly reduces the number of baryon states since some of degrees of freedom are frozen and thus the number of possible excitations is substantially smaller

Baryons with one and two heavy quarks:

- Heavy baryons  $qqQ$  ( $Q = c, b$ )
  - two light quarks form a diquark  $d = (qq)$
  - all excitations occur in the quark-diquark bound system (no internal diquark excitations)
  - in the last few years the number of the observed charmed and bottom baryons almost doubled
  - due to the poor statistics, the quantum numbers of most of the excited states of heavy baryons are not known experimentally and are usually prescribed following the quark model predictions
- Doubly heavy baryons  $qQQ$  ( $q = u, d, s, Q = c, b$ )
  - two heavy quarks form a diquark  $d = QQ$
  - excitations both in diquark and in quark-diquark systems are considered
  - lowest excitations occur in a diquark
  - **first reliable experimental data on  $\Xi_{cc}^{++}$  were recently presented by LHCb**

## Baryon spectroscopy

- Main assumption: quark–diquark picture of baryons

Three-body calculation  $\longrightarrow$  two-step two-body calculation

- Diquark is a composite  $(qq')$  system:

— diquark is not a point-like object: Its interaction with gluons is smeared by the form factor expressed through the overlap integral of diquark wave functions

- Pauli principle for ground state diquarks:

—  $(qq')$  diquark can have  $S = 0, 1$  (scalar  $[q, q']$ , axial vector  $\{q, q'\}$ )

—  $(qq)$  diquarks can have only  $S = 1$  (axial vector  $\{q, q\}$ )

- Light quarks, light diquarks and heavy quarks are considered fully relativistically without  $v/c$  expansion

## RELATIVISTIC QUARK MODEL

Relativistic quasipotential equation of Schrödinger type:

$$\left( \frac{b^2(M)}{2\mu_R} - \frac{\mathbf{p}^2}{2\mu_R} \right) \Psi_M(\mathbf{p}) = \int \frac{d^3q}{(2\pi)^3} V(\mathbf{p}, \mathbf{q}; M) \Psi_M(\mathbf{q})$$

$\mathbf{p}$  - center-of-mass relative momentum of quarks (diquarks)

$M$  - bound state mass ( $M = E_1 + E_2$ )

$\mu_R$  - relativistic reduced mass:

$$\mu_R = \frac{E_1 E_2}{E_1 + E_2} = \frac{M^4 - (m_1^2 - m_2^2)^2}{4M^3}$$

$b(M)$  - on-mass-shell relative momentum in cms:

$$b^2(M) = \frac{[M^2 - (m_1 + m_2)^2][M^2 - (m_1 - m_2)^2]}{4M^2}$$

$E_{1,2}$  - center-of-mass energies:

$$E_1 = \frac{M^2 - m_2^2 + m_1^2}{2M}, \quad E_2 = \frac{M^2 - m_1^2 + m_2^2}{2M}$$



- **Baryons in quark-diquark picture**

1. **(qq)-interaction:**

$$V_{qq} = \frac{1}{2} V_{q\bar{q}}$$

$$V_{q\bar{q}}(\mathbf{p}, \mathbf{q}; M) = \bar{u}_1(p)\bar{u}_2(-p) \left\{ \frac{4}{3} \alpha_s D_{\mu\nu}(\mathbf{k}) \gamma_1^\mu \gamma_2^\nu + V_{\text{conf}}^V(\mathbf{k}) \Gamma_1^\mu \Gamma_{2;\mu} + V_{\text{conf}}^S(\mathbf{k}) \right\} u_1(q) u_2(-q)$$

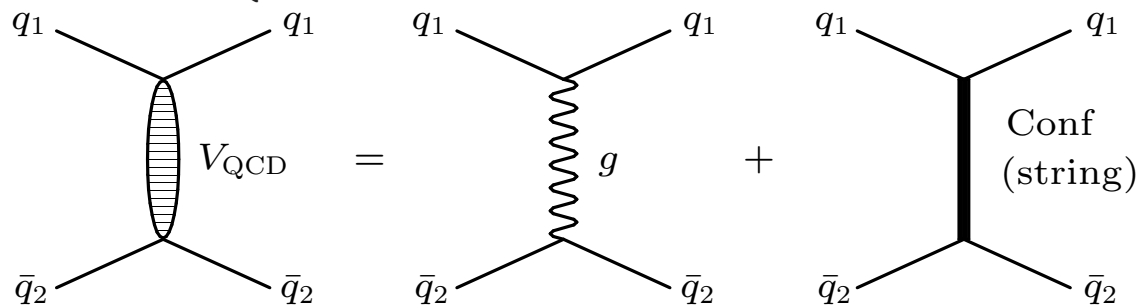

$$\mathbf{k} = \mathbf{p} - \mathbf{q}$$

$D_{\mu\nu}(\mathbf{k})$  - (perturbative) gluon propagator

$\Gamma_\mu(\mathbf{k})$  - effective long-range vertex with **Pauli term**:

$$\Gamma_\mu(\mathbf{k}) = \gamma_\mu + \frac{i\kappa}{2m} \sigma_{\mu\nu} k^\nu,$$

$\kappa$  - anomalous chromomagnetic moment of quark,

$$u^\lambda(p) = \sqrt{\frac{\epsilon(p) + m}{2\epsilon(p)}} \begin{pmatrix} 1 \\ \frac{\boldsymbol{\sigma}\mathbf{p}}{\epsilon(p) + m} \end{pmatrix} \chi^\lambda, \quad \epsilon(p) = \sqrt{\mathbf{p}^2 + m^2}$$

- Lorentz structure of the confining quark potential

$$V_{\text{conf}} = V_{\text{conf}}^V + V_{\text{conf}}^S$$

In nonrelativistic limit

$$\left. \begin{aligned} V_{\text{conf}}^V(r) &= (1 - \varepsilon)(Ar + B) \\ V_{\text{conf}}^S(r) &= \varepsilon(Ar + B) \end{aligned} \right\} \text{Sum : } (Ar + B)$$

$\varepsilon$  - mixing parameter

$$V_{\text{NR}}(r) = V_{\text{Coul}}(r) + V_{\text{conf}}(r) = -\frac{4\alpha_s}{3r} + Ar + B \quad (\text{Cornell potential})$$

$$V_{\text{Coul}}(r) = -\frac{4\alpha_s}{3r}$$

2.  $(dQ)$ -interaction:

$$d = (qq')$$

$$V(\mathbf{p}, \mathbf{q}; M) = \frac{\langle d(P) | J_\mu | d(Q) \rangle}{2\sqrt{E_d(p)E_d(q)}} \bar{u}_Q(p) \frac{4}{3} \alpha_s D_{\mu\nu}(\mathbf{k}) \gamma^\nu u_Q(q)$$

$$+ \psi_d^*(P) \bar{u}_Q(p) J_{d;\mu} \Gamma_Q^\mu V_{\text{conf}}^V(\mathbf{k}) u_Q(q) \psi_d(Q) + \psi_d^*(P) \bar{u}_Q(p) V_{\text{conf}}^S(\mathbf{k}) u_Q(q) \psi_d(Q)$$

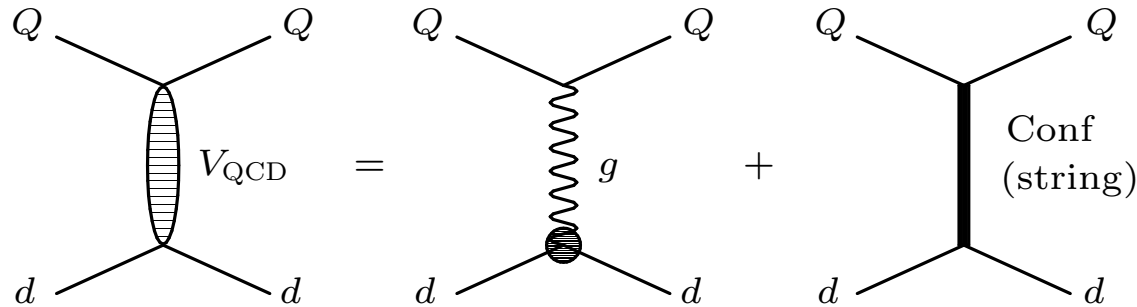

$J_{d,\mu}$  – effective long-range vector vertex of diquark:

$$J_{d;\mu} = \begin{cases} \frac{(P+Q)_\mu}{2\sqrt{E_d(p)E_d(q)}} & \text{for scalar diquark} \\ -\frac{(P+Q)_\mu}{2\sqrt{E_d(p)E_d(q)}} + \frac{i\mu_d}{2M_d} \Sigma_\mu^\nu k_\nu & \text{for axial vector diquark } (\mu_d = 0) \end{cases}$$

$\mu_d$  - total chromomagnetic moment of axial vector diquark

diquark spin matrix:  $(\Sigma_{\rho\sigma})_\mu^\nu = -i(g_{\mu\rho}\delta_\sigma^\nu - g_{\mu\sigma}\delta_\rho^\nu)$

$\mathbf{S}_d$  - axial vector diquark spin:  $(S_{d;k})_{il} = -i\varepsilon_{kil}$

$\psi_d(P)$  – free diquark wave function:

$$\psi_d(p) = \begin{cases} 1 & \text{for scalar diquark} \\ \varepsilon_d(p) & \text{for axial vector diquark} \end{cases}$$

$\varepsilon_d(p)$  – polarization vector of axial vector diquark

Vertex of diquark-gluon interaction:

$$\langle d(P) | J_\mu(0) | d(Q) \rangle = \int \frac{d^3 p d^3 q}{(2\pi)^6} \bar{\Psi}_P^d(\mathbf{p}) \Gamma_\mu(\mathbf{p}, \mathbf{q}) \Psi_Q^d(\mathbf{q}) \Rightarrow F(k^2)$$

$\Gamma_\mu$  – two-particle vertex function of the diquark-gluon interaction

The calculated diquark-gluon interaction form factor can be parameterized by

$$F(r) = 1 - e^{-\xi r - \zeta r^2}$$

The same formulas hold for the ( $dq$ ) interaction

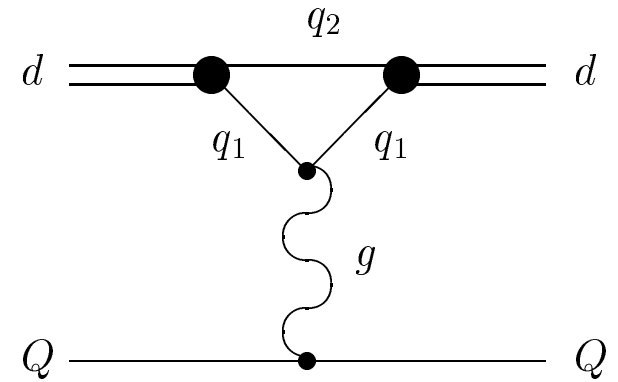

- Parameters of the model

Parameters  $A$ ,  $B$ ,  $\kappa$ ,  $\varepsilon$  and quark masses fixed from analysis of meson masses and radiative decays:

$\varepsilon = -1$  from heavy quarkonium radiative decays ( $J/\psi \rightarrow \eta_c + \gamma$ ) and HQET

$\kappa = -1$  from fine splitting of heavy quarkonium  $^3P_J$  states and HQET

$(1 + \kappa) = 0 \implies$  **vanishing long-range chromomagnetic interaction !** (flux tube model)

### Freezing of $\alpha_s$

$$\alpha_s(\mu) = \frac{4\pi}{\beta_0 \ln \frac{\mu^2 + M_0^2}{\Lambda^2}}, \quad \beta_0 = 11 - \frac{2}{3}n_f, \quad \mu = \frac{2m_1 m_2}{m_1 + m_2},$$

$$M_0 = 2.24\sqrt{A} = 0.95 \text{ GeV}$$

### Quasipotential parameters:

$$A = 0.18 \text{ GeV}^2, \quad B = -0.30 \text{ GeV},$$

$$\Lambda = 0.413 \text{ GeV (from } M_\rho)$$

### Quark masses:

$$m_b = 4.88 \text{ GeV}$$

$$m_s = 0.50 \text{ GeV}$$

$$m_c = 1.55 \text{ GeV}$$

$$m_{u,d} = 0.33 \text{ GeV}$$

# MASSES OF HEAVY BARYONS

Quark-diquark picture of heavy baryons reduces relativistic three-body problem to two step two-body calculation:

## First step

- Masses and form factors of light diquarks are calculated
  - Only ground-state scalar and axial vector diquarks are considered for heavy baryons
  - Ground-state as well as orbital and radial excitations of heavy diquarks are necessary for doubly heavy baryons

## Second step

- Heavy baryon is considered as a bound heavy-quark–light-diquark state
  - All excitations are assumed to occur between heavy quark and light diquark
- Doubly heavy baryon is considered as a bound light-quark–heavy-diquark state
  - Both excitations in quark-diquark system and excitations of heavy diquark are considered
- Significantly less excited states than in genuine three-quark picture

## Light diquarks

Table 1: Masses of light ground state diquarks (in MeV)

Quark content	Diquark type	Mass				
		our	NJL	BSE	BSE	Lattice
$[u, d]$	S	710	705	737	820	694(22)
$\{u, d\}$	A	909	875	949	1020	806(50)
$[u, s]$	S	948	895	882	1100	
$\{u, s\}$	A	1069	1050	1050	1300	
$\{s, s\}$	A	1203	1215	1130	1440	

Table 2: Masses  $M$  and form factor parameters of light diquarks.

Quark content	Diquark type	$M$ (MeV)	$\xi$ (GeV)	$\zeta$ (GeV <sup>2</sup> )
$[u, d]$	S	710	1.09	0.185
$\{u, d\}$	A	909	1.185	0.365
$[u, s]$	S	948	1.23	0.225
$\{u, s\}$	A	1069	1.15	0.325
$\{s, s\}$	A	1203	1.13	0.280

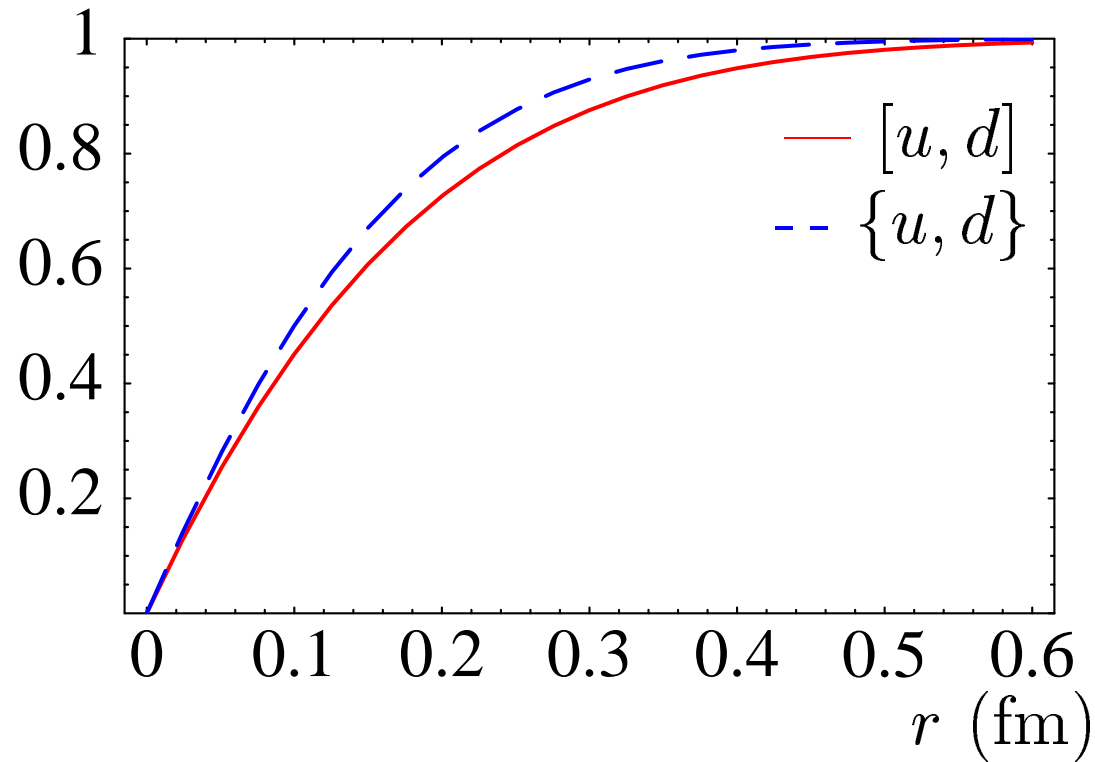

Figure 1: Form factors  $F(r)$  for scalar  $[u, d]$  (solid line) and axial vector  $\{u, d\}$  (dashed line) diquarks.

## Heavy diquarks

Table 3: Masses  $M$  and form factor parameters of heavy diquarks.

Diquark State	$cc$			$bb$		
	Mass (GeV)	$\xi$ (GeV)	$\zeta$ (GeV <sup>2</sup> )	Mass (GeV)	$\xi$ (GeV)	$\zeta$ (GeV <sup>2</sup> )
$1^3S_1$	3.226	1.30	0.42	9.778	1.30	1.60
$1^1P_1$	3.460	0.74	0.315	9.944	0.90	0.59
$2^3S_1$	3.535	0.67	0.19	10.015	0.85	0.31
$2^1P_1$	3.712	0.60	0.155	10.132	0.65	0.215
$3^3S_1$	3.782	0.57	0.12	10.196	0.66	0.155
$3^1P_1$	3.928	0.55	0.075	10.305	0.58	0.120

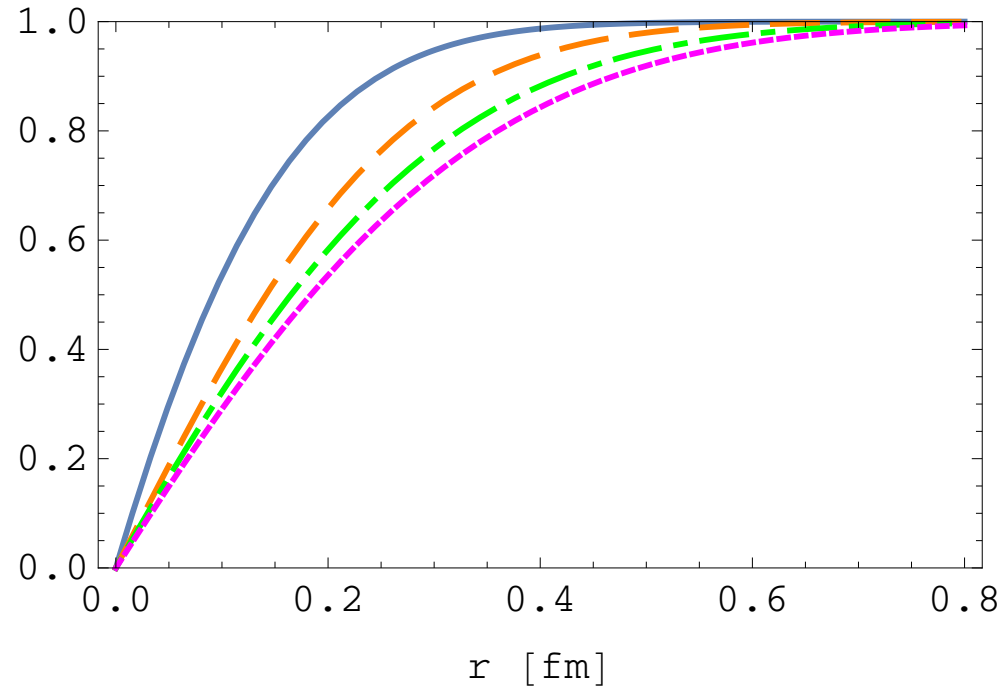

Figure 2: The form factors  $F(r)$  for the  $cc$  diquark. The solid curve is for the  $1S$  state, the dashed curve for the  $1P$  state, the dashed-dotted curve for the  $2S$  state, and the dotted curve for the  $2P$  state.



## Heavy baryon masses

We do not expand the potential of the quark–diquark interaction either in  $p/m_Q$  or in  $p/m_d$  and treat both diquark and quark fully relativistically.

The resulting quasipotential of  $(Qd)$  interaction is extremely nonlocal in configuration space.

To simplify the potential and to make it local in configuration space we replace the off-mass-shell energies by the on-mass-shell energies:

- the diquark energies

$$E_d(p) \equiv \sqrt{\mathbf{p}^2 + M_d^2} \rightarrow E_d = \frac{M^2 - m_Q^2 + M_d^2}{2M},$$

- the quark energies

$$\epsilon_Q(p) \equiv \sqrt{\mathbf{p}^2 + m_Q^2} \rightarrow E_Q = \frac{M^2 - M_d^2 + m_Q^2}{2M}.$$

These substitutions make the Fourier transform of the potential local, but introduce a complicated nonlinear dependence of the potential on the baryon mass  $M$  through the on-mass-shell energies  $E_d$  and  $E_Q$ . Such substitution is widely used in quantum electrodynamics.

The resulting ( $Qd$ ) potential

$$V(r) = V_{\text{SI}}(r) + V_{\text{SD}}(r),$$

where  $V_{\text{SI}}(r)$  is the spin-independent part, and the structure of the spin-dependent potential  $V_{\text{SD}}(r)$  is given by

$$V_{\text{SD}}(r) = a_1 \mathbf{L}\mathbf{S}_d + a_2 \mathbf{L}\mathbf{S}_Q + b \left[ -\mathbf{S}_d\mathbf{S}_Q + \frac{3}{r^2}(\mathbf{S}_d\mathbf{r})(\mathbf{S}_Q\mathbf{r}) \right] + c \mathbf{S}_d\mathbf{S}_Q,$$

where  $\mathbf{L}$  is the orbital angular momentum,  $\mathbf{S}_d$  and  $\mathbf{S}_Q$  are the diquark and heavy quark spin operators, respectively. The coefficients  $a_1$ ,  $a_2$ ,  $b$  and  $c$  are expressed through the corresponding derivatives of the smeared Coulomb and confining potentials, e.g.:

$$c = \frac{2}{3} \frac{1}{E_d E_Q} \left\{ \Delta \hat{V}_{\text{Coul}}(r) - \frac{\mu_d E_d}{2 M_d} \left[ \frac{E_Q - m_Q}{2m_Q} - (1 + \kappa) \frac{E_Q + m_Q}{2m_Q} \right] \Delta V_{\text{conf}}^V(r) \right\}.$$

$\Delta$  is the Laplace operator

The smeared Coulomb potential which accounts for the diquark internal structure

$$\hat{V}_{\text{Coul}}(r) = -\frac{4}{3} \alpha_s \frac{F(r)}{r}.$$

## Heavy baryons

Table 4: Masses of the ground state heavy baryons (in MeV). our – EFG, Phys. Rev. D (2005)

Baryon	$I(J^P)$	Theory					Experiment PDG	
		our (2005)	Capstick Isgur	Roncaglia et al.	Savage	Jenkins		Mathur* et al.
$\Lambda_c$	$0(\frac{1}{2}^+)$	2286	2265	2285			2290	2286.46(14)
$\Sigma_c$	$1(\frac{1}{2}^+)$	2443	2440	2453			2452	2453.76(18)
$\Sigma_c^*$	$1(\frac{3}{2}^+)$	2519	2495	2520	2518		2538	2518.0(0.5)
$\Xi_c$	$\frac{1}{2}(\frac{1}{2}^+)$	2476		2468			2473	2470.88( $_{80}^{34}$ )
$\Xi_c'$	$\frac{1}{2}(\frac{1}{2}^+)$	2579		2580	2579	2580.8(2.1)	2599	2577.9(2.9)
$\Xi_c^*$	$\frac{1}{2}(\frac{3}{2}^+)$	2649		2650			2680	2645.9(0.5)
$\Omega_c$	$0(\frac{1}{2}^+)$	2698		2710			2678	2695.2(1.7)
$\Omega_c^*$	$0(\frac{3}{2}^+)$	<b>2768</b>		2770	2768	2760.5(4.9)	2752	<b>2765.9(2.0)</b>
$\Lambda_b$	$0(\frac{1}{2}^+)$	5620	5585	5620			5672	5619.51(23)
$\Sigma_b$	$1(\frac{1}{2}^+)$	<b>5808</b>	5795	5820		5824.2(9.0)	5847	<b>5811.3(1.9)</b>
$\Sigma_b^*$	$1(\frac{3}{2}^+)$	<b>5834</b>	5805	5850		5840.0(8.8)	5871	<b>5832.1(1.9)</b>
$\Xi_b$	$\frac{1}{2}(\frac{1}{2}^+)$	<b>5803</b>		5810		5805.7(8.1)	5788	<b>5794.4(1.2)</b>
$\Xi_b'$	$\frac{1}{2}(\frac{1}{2}^+)$	<b>5937</b>		5950		5950.9(8.5)	5936	<b>5935.02(5)</b>
$\Xi_b^*$	$\frac{1}{2}(\frac{3}{2}^+)$	<b>5963</b>		5980		5966.1(8.3)	5959	<b>5955.33(13)</b>
$\Omega_b$	$0(\frac{1}{2}^+)$	<b>6064</b>		6060		6068.7(11.1)	6040	<b>6048.0(1.9)</b>
$\Omega_b^*$	$0(\frac{3}{2}^+)$	6088		6090		6083.2(11.0)	6060	

\* error estimates of lattice calculations —  $\sim 50$  MeV for charmed,  $\sim 100$  MeV for bottom baryons

Table 5: Masses  $M$  of the  $\Lambda_Q$  ( $Q = c, b$ ) heavy baryons (in MeV).

$I(J^P)$	$Qd$ state	$Q = c$			$Q = b$		
		$M$	status	$M^{\text{exp}}$	$M$	status	$M^{\text{exp}}$
$0(\frac{1}{2}^+)$	$1S$	2286	****	2286.46(14)	5620	***	5619.51(23)
	$2S$	2769	*	2766.6(2.4)?	6089		
	$3S$	3130			6455		
	$4S$	3437			6756		
	$5S$	3715			7015		
	$6S$	3973			7256		
$0(\frac{1}{2}^-)$	$1P$	2598	***	2592.25(28)	5930	***	5912.11(26)
	$2P$	2983	***	2944.8( $\frac{1.4}{1.5}$ )?	6326		
	$3P$	3303			6645		
	$4P$	3588			6917		
	$5P$	3852			7157		
$0(\frac{3}{2}^-)$	$1P$	2627	***	2628.1(6)	5942	***	5919.81(23)
	$2P$	3005			6333		
	$3P$	3322			6651		
	$4P$	3606			6922		
	$5P$	3869			7171		
$0(\frac{3}{2}^+)$	$1D$	2874	new	2856.1.3( $\frac{2.3}{5.9}$ )	6190		
	$2D$	3189			6526		
	$3D$	3480			6811		
	$4D$	3747			7060		

Table 5: (continued)

$I(J^P)$	$Qd$ state	$Q = c$			$Q = b$		
		$M$	status	$M^{\text{exp}}$	$M$	status	$M^{\text{exp}}$
$0(\frac{5}{2}^+)$	$1D$	2880	***	2881.75(35)	6196		
	$2D$	3209			6531		
	$3D$	3500			6814		
	$4D$	3767			7063		
$0(\frac{5}{2}^-)$	$1F$	3097			6408		
	$2F$	3375			6705		
	$3F$	3646			6964		
	$4F$	3900			7196		
$0(\frac{7}{2}^-)$	$1F$	3078			6411		
	$2F$	3393			6708		
	$3F$	3667			6966		
	$4F$	3922			7197		
$0(\frac{7}{2}^+)$	$1G$	3270			6598		
	$2G$	3546			6867		
$0(\frac{9}{2}^+)$	$1G$	3284			6599		
	$2G$	3564			6868		
$0(\frac{9}{2}^-)$	$1H$	3444			6767		
$0(\frac{11}{2}^-)$	$1H$	3460			6766		

Table 6: Comparison of theoretical predictions for masses of the  $\Lambda_c$  baryons (in MeV).

$J^P$	Experiment			Theory			
	State	Status	Mass	our	Chen et al.	Roberts Pervin	Capstick Isgur
$\frac{1}{2}^+$	$\Lambda_c$	****	2286.46	2286	2286	2286	2265
	$\Lambda_c(2765)$	*	2766.6	2769	2766	2791	2775
				3130	3112	3154	3170
				3437	3397		
$\frac{1}{2}^-$	$\Lambda_c(2595)$	***	2592.3	2598	2591	2625	2630
	$\Lambda_c(2940)$	***	2944.8	2983	2989		2780
				3303	3296		2830
$\frac{3}{2}^-$	$\Lambda_c(2625)$	***	2628.1	2627	2629	2636	2640
				3005	3000		2840
				3322	3301		2885
$\frac{3}{2}^+$	$\Lambda_c(2860)$	new	2856.1	2874	2857	2887	2910
				3189	3188	3120	3035
$\frac{5}{2}^+$	$\Lambda_c(2880)$	***	2881.75	2880	2879	2887	2910
				3209	3198	3125	3140
$\frac{5}{2}^-$				3097	3075	2872	2900
$\frac{7}{2}^-$				3078	3092		3125
$\frac{7}{2}^+$				3270	3267		3175
$\frac{9}{2}^+$				3284	3280		

Table 7: Masses of the  $\Sigma_Q$  ( $Q = c, b$ ) heavy baryons (in MeV).

$I(J^P)$	$Qd$ state	$Q = c$			$Q = b$		
		$M$	status	$M^{\text{exp}}$	$M$	status	$M^{\text{exp}}$
$1(\frac{1}{2}^+)$	$1S$	2443	****	2453.76(18)	5808	***	5807.8(2.7)
	$2S$	2901			6213		
	$3S$	3271			6575		
	$4S$	3581			6869		
	$5S$	3861			7124		
$1(\frac{3}{2}^+)$	$1S$	2519	***	2518.0(5)	5834	***	5829.0(3.4)
	$2S$	2936	***	2939.3( $\frac{1.4}{1.5}$ )?	6226		
	$3S$	3293			6583		
	$4S$	3598			6876		
	$5S$	3873			7129		
$1(\frac{1}{2}^-)$	$1P$	2799	***	2802( $\frac{4}{7}$ )	6101		
	$2P$	3172			6440		
	$3P$	3488			6756		
	$4P$	3770			7024		
	$1P$	2713			6095		
	$2P$	3125			6430		
	$3P$	3455			6742		
	$4P$	3743			7008		
$1(\frac{3}{2}^-)$	$1P$	2798	***	2802( $\frac{4}{7}$ )	6096	new	6098.0(1.8)
	$2P$	3172			6430		
	$3P$	3486			6742		
	$4P$	3768			7009		

Table 7: (continued)

$I(J^P)$	$Qd$ state	$Q = c$			$Q = b$		
		$M$	status	$M^{\text{exp}}$	$M$	status	$M^{\text{exp}}$
$1(\frac{3}{2}^-)$	$1P$	2773	*	2766.6(2.4)?	6087		
	$2P$	3151			6423		
	$3P$	3469			6736		
	$4P$	3753			7003		
$1(\frac{5}{2}^-)$	$1P$	2789			6084		
	$2P$	3161			6421		
	$3P$	3475			6732		
	$4P$	3757			6999		
$1(\frac{1}{2}^+)$	$1D$	3041			6311		
	$2D$	3370			6636		
$1(\frac{3}{2}^+)$	$1D$	3043			6326		
	$2D$	3366			6647		
	$1D$	3040			6285		
	$2D$	3364			6612		
$1(\frac{5}{2}^+)$	$1D$	3038			6284		
	$2D$	3365			6612		
	$1D$	3023			6270		
	$2D$	3349			6598		
$1(\frac{7}{2}^+)$	$1D$	3013			6260		
	$2D$	3342			6590		



Table 8: Masses  $M$  of the  $\Omega_Q$  ( $Q = c, b$ ) heavy baryons (in MeV).

$I(J^P)$	$Qd$ state	$Q = c$			$Q = b$		
		$M$	status	$M^{\text{exp}}$	$M$	status	$M^{\text{exp}}$
$0(\frac{1}{2}^+)$	$1S$	2698	***	2695.2(1.7)	6064	***	6046.4(1.9)
$0(\frac{1}{2}^+)$	$2S$	3088	new	3090.2( $\frac{7}{8}$ )	6450		
$0(\frac{1}{2}^+)$	$3S$	3489			6804		
$0(\frac{1}{2}^+)$	$4S$	3814			7091		
$0(\frac{1}{2}^+)$	$5S$	4102			7338		
$0(\frac{3}{2}^+)$	$1S$	2768	***	2765.9(2.0)	6088		
$0(\frac{3}{2}^+)$	$2S$	3123	new	3119.1( $\frac{1.0}{1.1}$ )	6461		
$0(\frac{3}{2}^+)$	$3S$	3510			6811		
$0(\frac{3}{2}^+)$	$4S$	3830			7096		
$0(\frac{3}{2}^+)$	$5S$	4114			7343		
$0(\frac{1}{2}^-)$	$1P$	3055			6339		
$0(\frac{1}{2}^-)$	$2P$	3435			6710		
$0(\frac{1}{2}^-)$	$3P$	3754			7009		
$0(\frac{1}{2}^-)$	$4P$	4037			7265		
$0(\frac{1}{2}^-)$	$1P$	2966			6330		
$0(\frac{1}{2}^-)$	$2P$	3384			6706		
$0(\frac{1}{2}^-)$	$3P$	3717			7003		
$0(\frac{1}{2}^-)$	$4P$	4009			7257		

Table 8: (continued)

$I(J^P)$	$Qd$ state	$Q = c$			$Q = b$		
		$M$	status	$M^{\text{exp}}$	$M$	status	$M^{\text{exp}}$
$0(\frac{3}{2}^-)$	$1P$	3054	new	$3065.6(\frac{6}{7})$	6340		
$0(\frac{3}{2}^-)$	$2P$	3433			6705		
$0(\frac{3}{2}^-)$	$3P$	3752			7002		
$0(\frac{3}{2}^-)$	$4P$	4036			7258		
$0(\frac{3}{2}^-)$	$1P$	3029	new	$3000.4(\frac{4}{6})$	6331		
$0(\frac{3}{2}^-)$	$2P$	3415			6699		
$0(\frac{3}{2}^-)$	$3P$	3737			6998		
$0(\frac{3}{2}^-)$	$4P$	4023			7250		
$0(\frac{5}{2}^-)$	$1P$	3051	new	$3050.2(\frac{4}{5})$	6334		
$0(\frac{5}{2}^-)$	$2P$	3427			6700		
$0(\frac{5}{2}^-)$	$3P$	3744			6996		
$0(\frac{5}{2}^-)$	$4P$	4028			7251		
$0(\frac{1}{2}^+)$	$1D$	3287			6540		
$0(\frac{3}{2}^+)$	$1D$	3298			6549		
$0(\frac{3}{2}^+)$	$1D$	3282			6530		
$0(\frac{5}{2}^+)$	$1D$	3297			6529		
$0(\frac{5}{2}^+)$	$1D$	3286			6520		
$0(\frac{7}{2}^+)$	$1D$	3283			6517		
$0(\frac{3}{2}^-)$	$1F$	3533			6763		

Table 9: Comparison of theoretical predictions for the masses of the  $\Omega_c$  states.

State $nL, J^P$	our RQM	Roberts QM	Shah QM	Perez-Rubio lattice	Chen lattice	Agaev QCD SR	Experiment. PDG+LHCb
$1S, 1/2^+$	2698	2718	2695	2648(28)	2695(28)	2685(123)	2695.2(1.7)
$2S, 1/2^+$	3088	3152	3100	3294(73)		3066(138)	3090.2( $^7_8$ )
$1S, 3/2^+$	2768	2776	2767	2709(32)	2781(25)	2769(89)	2765.9(2.0)
$2S, 3/2^+$	3123	3190	3126	3355(92)		3119(114)	3119.1( $^{1.0}_{1.1}$ )
$1P, 1/2^-$	2966	2977	3028	2995(46)	3015(45)		
$1P, 1/2^-$	3055	2990	3011				
$1P, 3/2^-$	3054	2986	2976	3016(69)			3065.6( $^6_7$ )
$1P, 3/2^-$	3029	2994	2993				3000.4( $^4_6$ )
$1P, 5/2^-$	3051	3014	2947				3050.2( $^4_5$ )

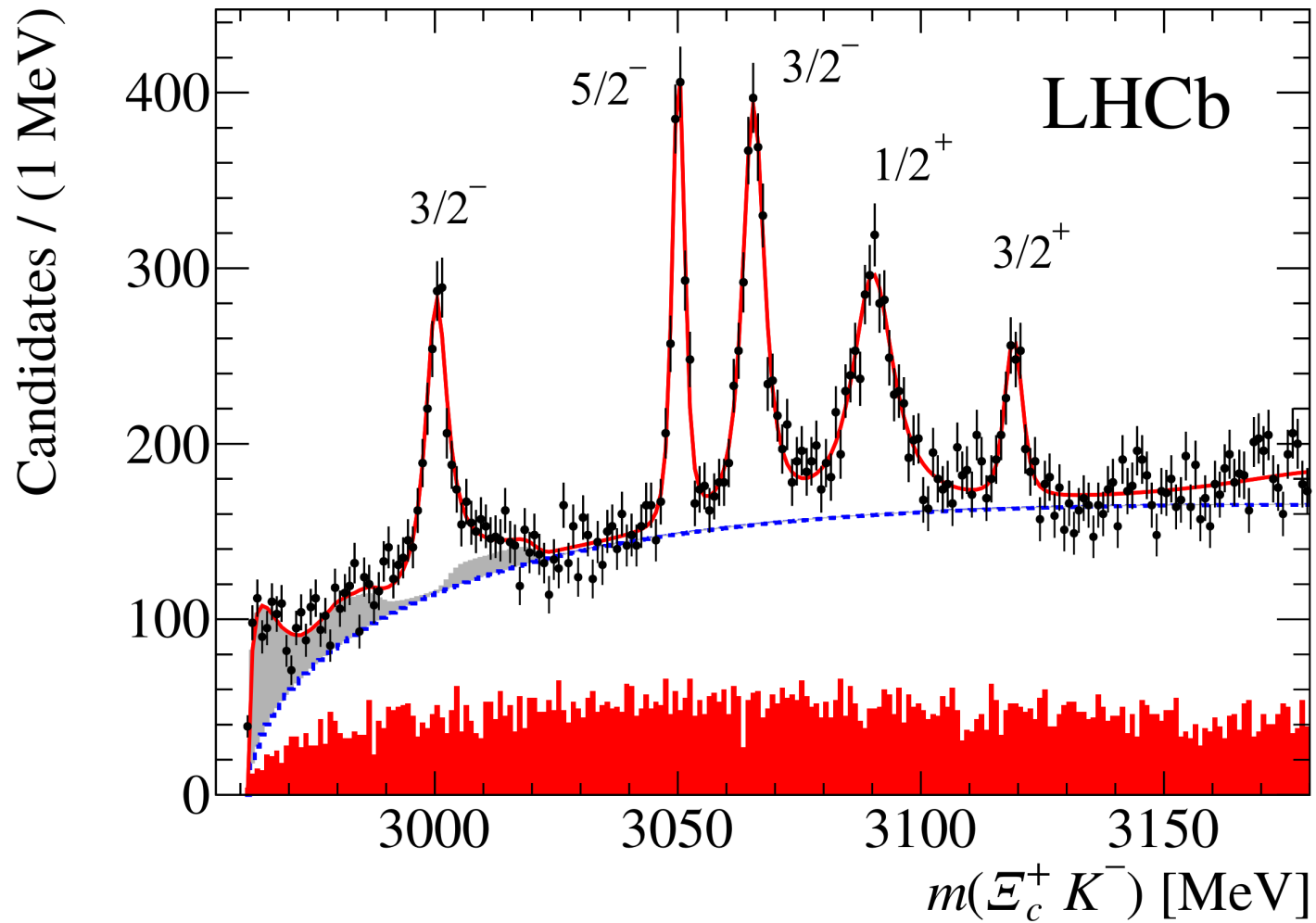

Figure 3: Proposed assignment of spins and parities of excited  $\Omega_c$  states observed by LHCb Collaboration.

Table 10: Masses of the  $\Xi_Q$  ( $Q = c, b$ ) heavy baryons with the axial vector diquark (in MeV).

$I(J^P)$	$Qd$ state	$Q = c$			$Q = b$		
		$M$	status	$M^{\text{exp}}$	$M$	status	$M^{\text{exp}}$
$\frac{1}{2}(\frac{1}{2}^+)$	$1S$	2579	***	2577.9(2.9)	5936	***	5935.02(5)
$\frac{1}{2}(\frac{1}{2}^+)$	$2S$	2983		2971.4(3.3)	6329		
$\frac{1}{2}(\frac{1}{2}^+)$	$3S$	3377			6687		
$\frac{1}{2}(\frac{1}{2}^+)$	$4S$	3695			6978		
$\frac{1}{2}(\frac{1}{2}^+)$	$5S$	3978			7229		
$\frac{1}{2}(\frac{3}{2}^+)$	$1S$	2649	***	2645.9(0.5)	5963	***	5955.33(13)
$\frac{1}{2}(\frac{3}{2}^+)$	$2S$	3026			6342		
$\frac{1}{2}(\frac{3}{2}^+)$	$3S$	3396			6695		
$\frac{1}{2}(\frac{3}{2}^+)$	$4S$	3709			6984		
$\frac{1}{2}(\frac{3}{2}^+)$	$5S$	3989			7234		
$\frac{1}{2}(\frac{1}{2}^-)$	$1P$	2936	*	2931(6)	6233		
$\frac{1}{2}(\frac{1}{2}^-)$	$2P$	3313			6611		
$\frac{1}{2}(\frac{1}{2}^-)$	$3P$	3630			6915		
$\frac{1}{2}(\frac{1}{2}^-)$	$4P$	3912			7174		
$\frac{1}{2}(\frac{1}{2}^-)$	$1P$	2854			6227	new	6226.9(2.1)
$\frac{1}{2}(\frac{1}{2}^-)$	$2P$	3267			6604		
$\frac{1}{2}(\frac{1}{2}^-)$	$3P$	3598			6906		

Table 10: (continued)

$I(J^P)$	$Qd$ state	$Q = c$			$Q = b$		
		$M$	status	$M^{\text{exp}}$	$M$	status	$M^{\text{exp}}$
$\frac{1}{2}(\frac{1}{2}^-)$	$4P$	3887			7164		
$\frac{1}{2}(\frac{3}{2}^-)$	$1P$	2935	*	2931(6)	6234		
$\frac{1}{2}(\frac{3}{2}^-)$	$2P$	3311			6605		
$\frac{1}{2}(\frac{3}{2}^-)$	$3P$	3628			6905		
$\frac{1}{2}(\frac{3}{2}^-)$	$4P$	3911			7163		
$\frac{1}{2}(\frac{3}{2}^-)$	$1P$	2912			6224	new	6226.9(2.1)
$\frac{1}{2}(\frac{3}{2}^-)$	$2P$	3293			6598		
$\frac{1}{2}(\frac{3}{2}^-)$	$3P$	3613			6900		
$\frac{1}{2}(\frac{3}{2}^-)$	$4P$	3898			7159		
$\frac{1}{2}(\frac{5}{2}^-)$	$1P$	2929	*	2931(6)	6226	new	6226.9(2.1)
$\frac{1}{2}(\frac{5}{2}^-)$	$2P$	3303			6596		
$\frac{1}{2}(\frac{5}{2}^-)$	$3P$	3619			6897		
$\frac{1}{2}(\frac{5}{2}^-)$	$4P$	3902			7156		
$\frac{1}{2}(\frac{1}{2}^+)$	$1D$	3163			6447		
$\frac{1}{2}(\frac{3}{2}^+)$	$1D$	3167			6459		
$\frac{1}{2}(\frac{3}{2}^+)$	$1D$	3160			6431		
$\frac{1}{2}(\frac{5}{2}^+)$	$1D$	3166			6432		
$\frac{1}{2}(\frac{5}{2}^+)$	$1D$	3153			6420		
$\frac{1}{2}(\frac{7}{2}^+)$	$1D$	3147	*	3122.9(1.3)	6414		

# Doubly heavy baryons

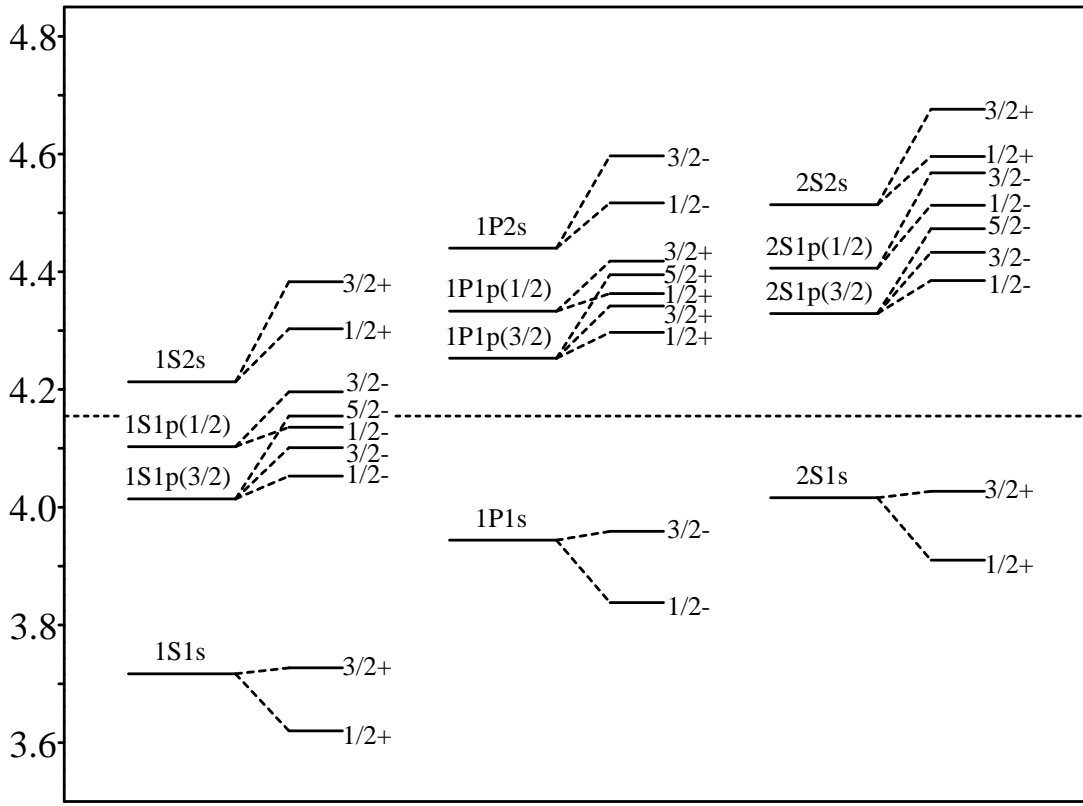

$\Xi_{cc}$

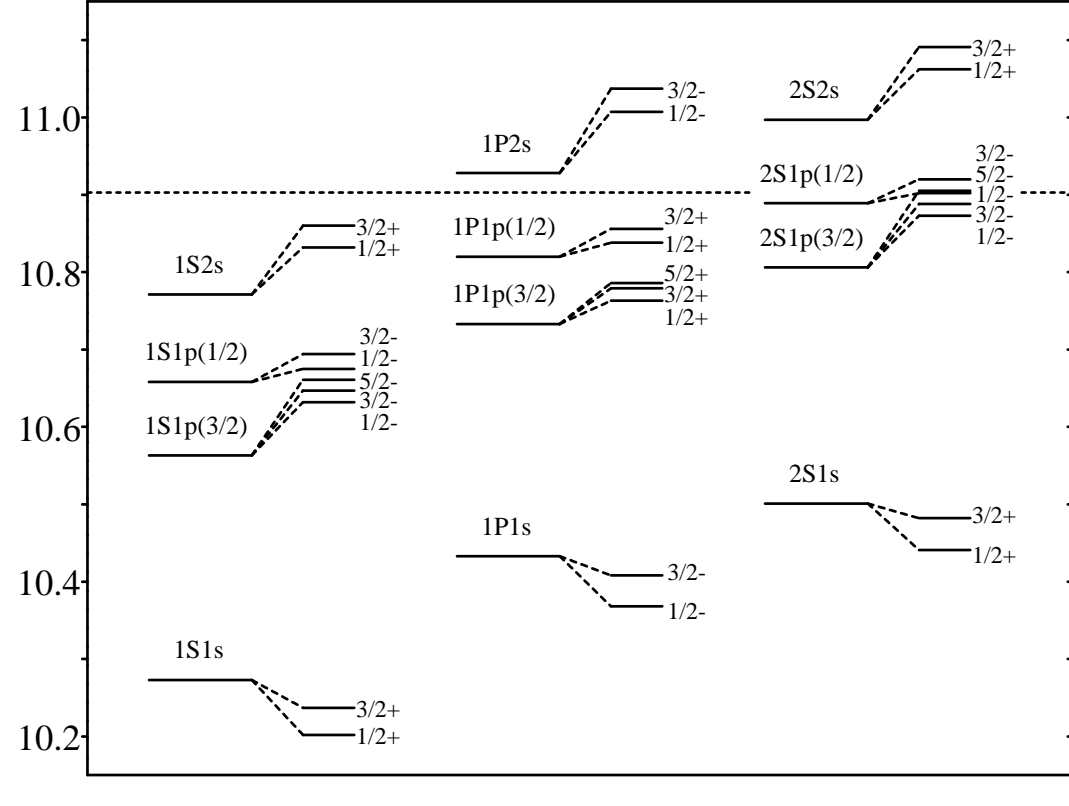

$\Xi_{bb}$

Figure 4: Mass spectrum of  $\Xi_{cc}$  and  $\Xi_{bb}$  baryons (for the infinitely heavy and finite diquark masses). The horizontal dashed line shows the  $\Lambda_c D$  and  $\Lambda_b D$  thresholds.

Table 11: Mass spectrum of ground states of doubly heavy baryons (in GeV). Comparison of different predictions.  $\{QQ\}$  denotes the diquark in the axial vector state and  $[QQ]$  denotes diquark in the scalar state.

Baryon	Quark content	$J^P$	our (2002)	Gershtein et al.	Roncaglia et al.	Narodetskii Trusov	Martynenko	Roberts Pervin	Karliner Rosner
$\Xi_{cc}$	$\{cc\}q$	$\frac{1}{2}^+$	3.620	3.478	3.66	3.69	3.510	3.676	3.627(12)
$\Xi_{cc}^*$	$\{cc\}q$	$\frac{3}{2}^+$	3.727	3.61	3.74		3.548	3.753	3.690(12)
$\Omega_{cc}$	$\{cc\}s$	$\frac{1}{2}^+$	3.778	3.59	3.74	3.86	3.719	3.815	
$\Omega_{cc}^*$	$\{cc\}s$	$\frac{3}{2}^+$	3.872	3.69	3.826		3.746	3.876	
$\Xi_{bb}$	$\{bb\}q$	$\frac{1}{2}^+$	10.202	10.093	10.34	10.16	10.130	10.340	10.162(12)
$\Xi_{bb}^*$	$\{bb\}q$	$\frac{3}{2}^+$	10.237	10.133	10.37		10.144	10.367	10.184(12)
$\Omega_{bb}$	$\{bb\}s$	$\frac{1}{2}^+$	10.359	10.18	10.37	10.34	10.422	10.454	
$\Omega_{bb}^*$	$\{bb\}s$	$\frac{3}{2}^+$	10.389	10.20	10.40		10.432	10.486	
$\Xi_{cb}$	$\{cb\}q$	$\frac{1}{2}^+$	6.933	6.82	7.04	6.96	6.792	7.011	6.914(13)
$\Xi'_{cb}$	$[cb]q$	$\frac{1}{2}^+$	6.963	6.85	6.99		6.825	7.047	6.933(12)
$\Xi_{cb}^*$	$\{cb\}q$	$\frac{3}{2}^+$	6.980	6.90	7.06		6.827	7.074	6.969(14)
$\Omega_{cb}$	$\{cb\}s$	$\frac{1}{2}^+$	7.088	6.91	7.09	7.13	6.999	7.136	
$\Omega'_{cb}$	$[cb]s$	$\frac{1}{2}^+$	7.116	6.93	7.06		7.022	7.165	
$\Omega_{cb}^*$	$\{cb\}s$	$\frac{3}{2}^+$	7.130	6.99	7.12		7.024	7.187	

$$M(\Xi_{cc}^{++}) = 3621.40 \pm 0.72 \pm 0.27 \pm 0.14 \text{ MeV}$$

LHCb 2017



# CONCLUSIONS

- Heavy baryons

Recent observations of excited charm baryons confirm predictions of the relativistic heavy-quark–light-diquark model of heavy baryons

- New state  $\Lambda_c(2860)$  is in accord with the predicted  $1D$ - state with  $J^P = \frac{3}{2}^+$
- The experimentally preferred quantum numbers  $J^P = \frac{5}{2}^+$  of  $\Lambda_c(2880)$  agree with our assignment of this state to  $1D$ - state with  $J^P = \frac{5}{2}^+$
- Observation of five new narrow  $\Omega_c$  states in the mass range 3000-3200 MeV agrees with our prediction of orbitally excited  $1P$ -states and radially excited  $2S$ -states in this mass region.
- $\Omega_c(3000)$ ,  $\Omega_c(3066)$ ,  $\Omega_c(3050)$  can be  $1P$ -states with  $J^P = \frac{3}{2}^-, \frac{3}{2}^-, \frac{5}{2}^-$
- $\Omega_c(3090)$  and  $\Omega_c(3119)$  states are most likely the first radially excited  $2S$  states with  $J^P = \frac{1}{2}^+, \frac{3}{2}^+$

All observed bottom baryon masses agree with predictions of our model.

- Doubly heavy baryons

- Mass of just observed  $\Xi_{cc}^{++}$  baryon is in excellent agreement with our prediction
- Masses of ground state doubly charm baryons are predicted to be in 3.5 - 3.9 GeV range.
- Masses of ground state doubly bottom baryons are predicted to be in 10.1 - 10.5 GeV range.
- Masses of ground state bottom-charm baryons are predicted to be in 6.8 - 7.2 GeV range.
- Rich spectra of narrow excited states below strong decay thresholds are expected.

We strongly encourage experimenters to search for new excited states of heavy baryons and especially for doubly heavy baryons!

We are eagerly waiting for new discoveries!

# BACKUP SLIDES

## Regge trajectories of heavy baryons

(a) The  $(J, M^2)$  Regge trajectory:

$$J = \alpha M^2 + \alpha_0$$

(b) The  $(n_r, M^2)$  Regge trajectory:

$$n_r = \beta M^2 + \beta_0,$$

$\alpha, \beta$  – slopes

$\alpha_0, \beta_0$  – intercepts.

Baryons:

$P = (-1)^{J-1/2}$  – natural parity

$P = (-1)^{J+1/2}$  – unnatural parity

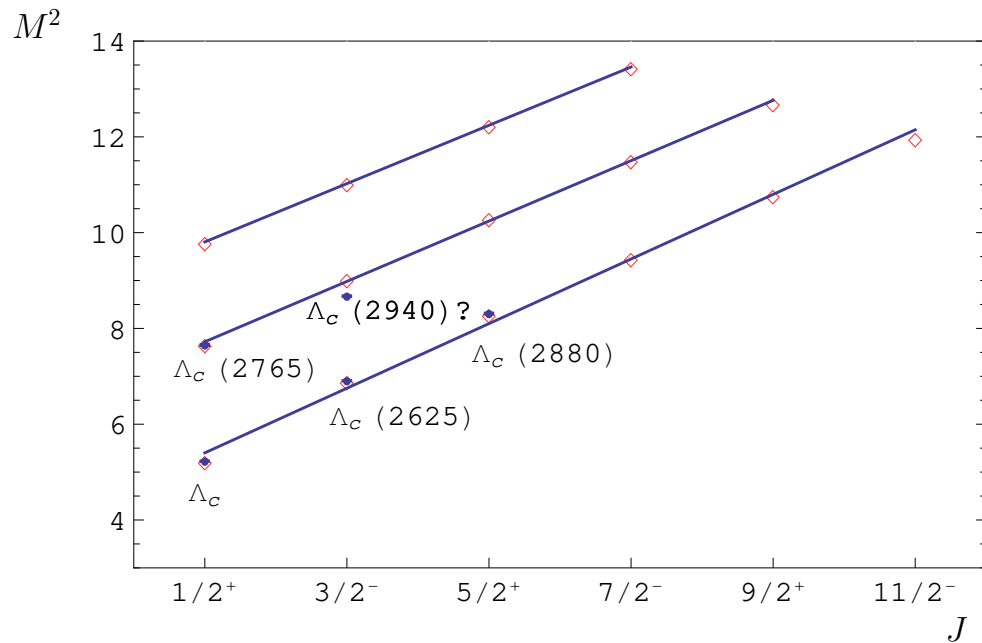

(a)

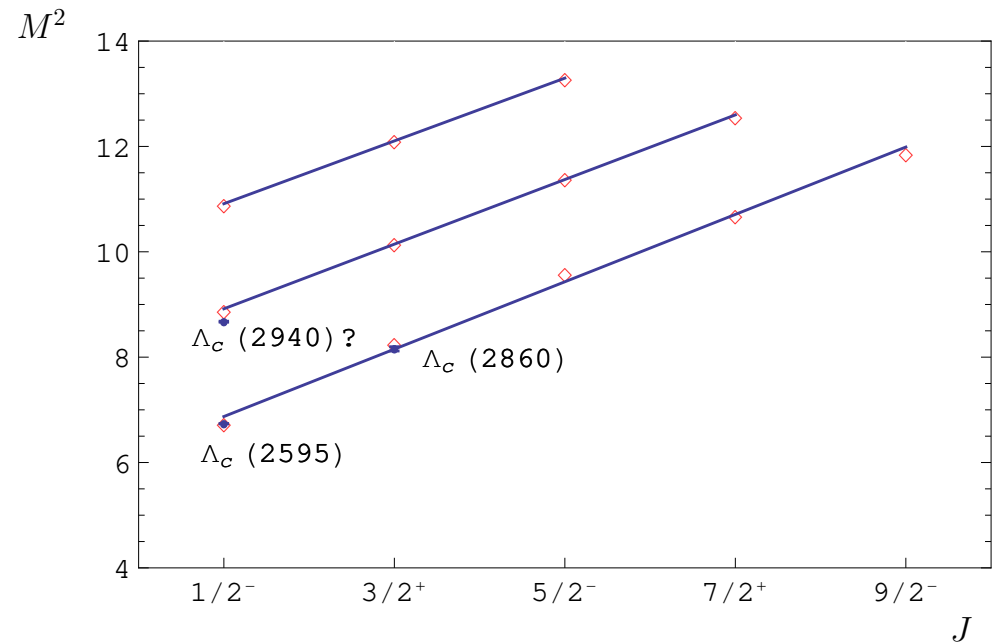

(b)

Figure 5: Parent and daughter  $(J, M^2)$  Regge trajectories for the  $\Lambda_c$  baryons with natural (a) and unnatural (b) parities. Diamonds are predicted masses. Available experimental data are given by dots with particle names;  $M^2$  is in GeV<sup>2</sup>.

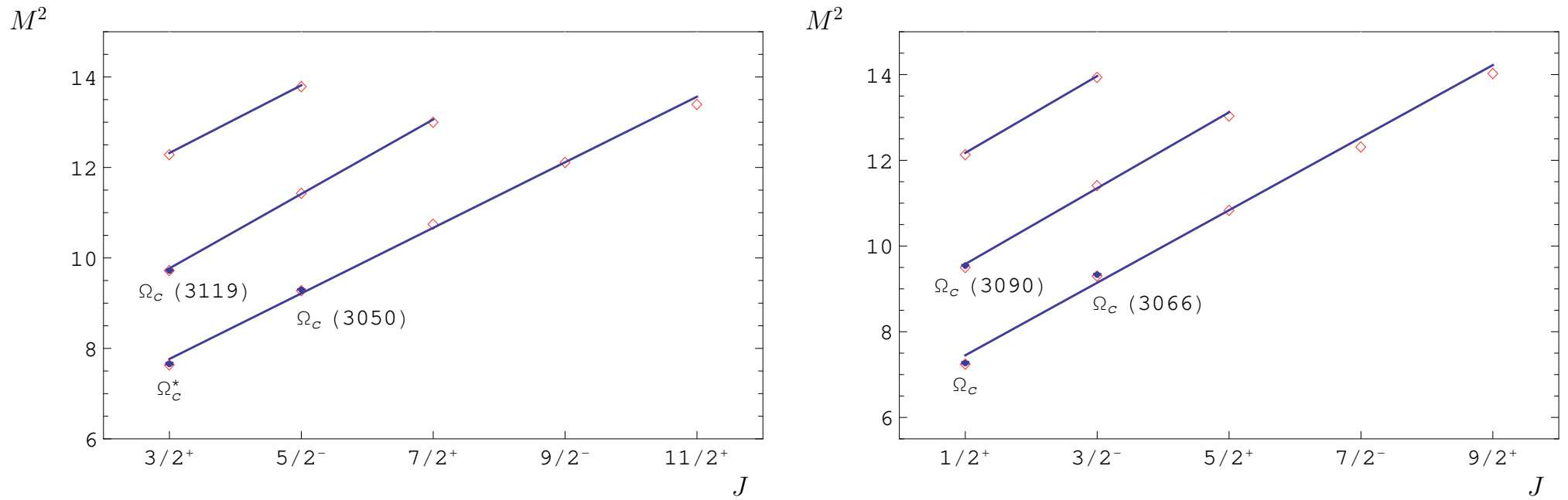

Figure 6: The  $(J, M^2)$  Regge trajectories for the  $\Omega_c$  baryons. Diamonds are predicted masses. Available experimental data are given by dots with particle names;  $M^2$  is in GeV<sup>2</sup>.

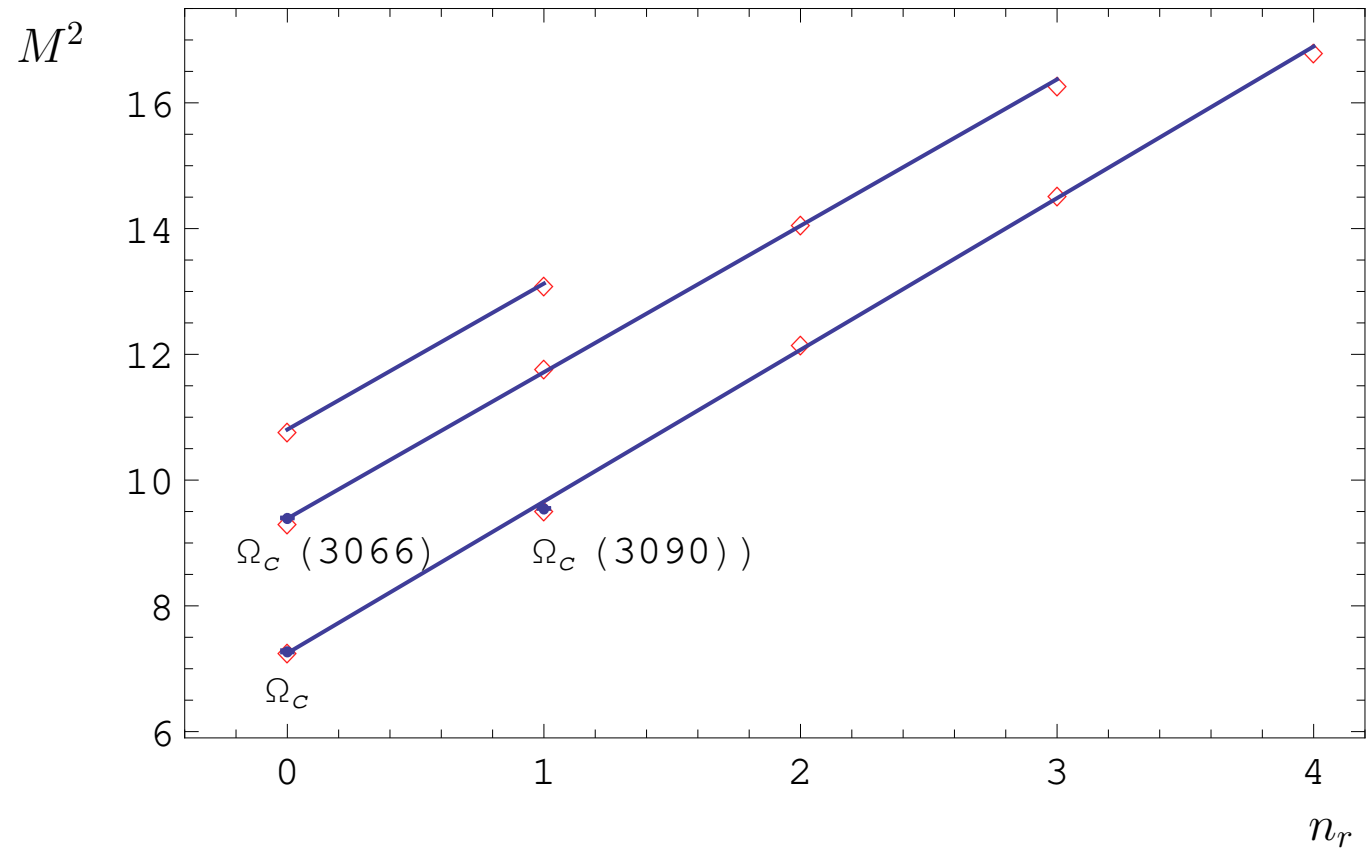

Figure 7: The  $(n_r, M^2)$  Regge trajectories for  $\Omega_c \left(\frac{1}{2}^+, S\right)$ ,  $\Omega_c \left(\frac{3}{2}^-, P\right)$  and  $\Omega_c \left(\frac{1}{2}^+, D\right)$  baryons (from bottom to top).

Table 12: Fitted parameters for the slope and intercept of the  $(J, M^2)$  parent and daughter Regge trajectories for heavy baryons with scalar and axial vector diquark.

Trajectory	$\alpha$ (GeV $^{-2}$ )	$\alpha_0$	$\alpha$ (GeV $^{-2}$ )	$\alpha_0$
$c[u, d]$	$\Lambda_c \left(\frac{1}{2}^+\right)$		$\Lambda_c \left(\frac{1}{2}^-\right)$	
parent	$0.741 \pm 0.024$	$-3.504 \pm 0.205$	$0.782 \pm 0.030$	$-4.874 \pm 0.276$
1 daughter	$0.793 \pm 0.013$	$-5.626 \pm 0.129$	$0.815 \pm 0.009$	$-6.769 \pm 0.099$
$c\{q, q\}$	$\Sigma_c \left(\frac{1}{2}^+\right)$		$\Sigma_c^* \left(\frac{3}{2}^+\right)$	
parent	$0.679 \pm 0.032$	$-3.670 \pm 0.278$	$0.778 \pm 0.019$	$-3.498 \pm 0.164$
1 daughter	$0.686 \pm 0.016$	$-5.289 \pm 0.158$	$0.785 \pm 0.001$	$-5.264 \pm 0.012$
$c[s, q]$	$\Xi_c \left(\frac{1}{2}^+\right)$		$\Xi_c \left(\frac{1}{2}^-\right)$	
parent	$0.686 \pm 0.025$	$-3.852 \pm 0.240$	$0.728 \pm 0.020$	$-5.249 \pm 0.211$
1 daughter	$0.739 \pm 0.015$	$-6.025 \pm 0.169$	$0.764 \pm 0.012$	$-7.244 \pm 0.142$
$c\{s, s\}$	$\Omega_c \left(\frac{1}{2}^+\right)$		$\Omega_c^* \left(\frac{3}{2}^+\right)$	
parent	$0.615 \pm 0.023$	$-4.065 \pm 0.023$	$0.690 \pm 0.020$	$-3.858 \pm 0.205$
1 daughter	$0.565 \pm 0.028$	$-4.910 \pm 0.316$	$0.608 \pm 0.012$	$-4.436 \pm 0.133$
$b[u, d]$	$\Lambda_b \left(\frac{1}{2}^+\right)$		$\Lambda_b \left(\frac{1}{2}^-\right)$	
parent	$0.352 \pm 0.017$	$-10.83 \pm 0.65$	$0.376 \pm 0.014$	$-12.82 \pm 0.58$
1 daughter	$0.397 \pm 0.015$	$-14.33 \pm 0.64$	$0.419 \pm 0.010$	$-16.33 \pm 0.45$
$b[s, q]$	$\Xi_b \left(\frac{1}{2}^+\right)$		$\Xi_b \left(\frac{1}{2}^-\right)$	
parent	$0.349 \pm 0.019$	$-11.49 \pm 0.80$	$0.381 \pm 0.014$	$-13.88 \pm 0.60$
1 daughter	$0.399 \pm 0.016$	$-15.27 \pm 0.69$	$0.423 \pm 0.011$	$-17.40 \pm 0.49$
$b\{s, s\}$	$\Omega_b \left(\frac{1}{2}^+\right)$		$\Omega_b^* \left(\frac{3}{2}^+\right)$	
parent	$0.365 \pm 0.013$	$-13.04 \pm 0.58$	$0.389 \pm 0.011$	$-13.02 \pm 0.47$
1 daughter	$0.378 \pm 0.052$	$-15.30 \pm 2.35$	$0.401 \pm 0.062$	$-15.33 \pm 2.74$



The slopes of the heavy and strange baryon Regge trajectories follow in both planes the regularities previously observed for light and heavy mesons:

- decrease with the increase of the diquark mass
- decrease with the increase of the parent baryon mass

The latter decrease is significantly more pronounced.

The ratio of slopes for heavy baryons and heavy-light mesons:

$$\langle \alpha_{Qqq} \rangle / \langle \alpha_{Q\bar{q}} \rangle \sim \langle \beta_{Qqq} \rangle / \langle \beta_{Q\bar{q}} \rangle \sim 1.4$$

## Strange baryons

Table 13: Masses of the ground states of hyperons (in MeV).

$J^P$	Experiment			Theory					
	State	Status	Mass	Our	Capstick Isgur	Loring et al.	Melde et al.	Santopinto Ferretti	Engel et al.
$\frac{1}{2}^+$	$\Lambda$	****	1115.683(6)	1115	1115	1108	1136	1116	1149(18)
$\frac{1}{2}^+$	$\Sigma$	****	1189.37(7)	1187	1190	1190	1180	1211	1216(15)
$\frac{3}{2}^+$	$\Sigma(1385)$	****	1382.80(35)	1381	1370	1411	1389	1334	1471(23)
$\frac{1}{2}^+$	$\Xi$	****	1321.71(7)	1330	1305	1310	1348	1317	1303(13)
$\frac{3}{2}^+$	$\Xi(1530)$	****	1531.80(32)	1518	1505	1539	1528	1552	1553(18)
$\frac{3}{2}^+$	$\Omega$	****	1672.45(29)	1678	1635	1636	1672		1642(17)

Table 14: Masses of the positive parity  $\Lambda$  states (in MeV).

$J^P$	Experiment			Theory					
	State	Status	Mass	Our	Capstick Isgur	Loring et al.	Melde et al.	Santopinto Ferretti	Engel et al.
$\frac{1}{2}^+$	$\Lambda$	****	1115.683(6)	1115	1115	1108	1136	1116	1149(18)
	$\Lambda(1600)$	***	1560-1600	1615	1680	1677	1625	1518	1807(94)
	$\Lambda(1710)$	*	1713(13)						
	$\Lambda(1810)$	***	1750-1810	1901	1830	1747	1799	1666	2112(54)
				1972	1910	1898	1955	2137(69)	
			1986	2010	2077		1960		
			2042	2105	2099				
			2099	2120	2132				
$\frac{3}{2}^+$	$\Lambda(1890)$	****	1850-1890	1854	1900	1823		1896	1991(103)
				1976	1960	1952		2058(139)	
				2130	1995	2045		2481(111)	
				2184	2050	2087			
				2202	2080	2133			
$\frac{5}{2}^+$	$\Lambda(1820)$	****	1815-1820	1825	1890	1834		1896	
				2098	2035	1999			
				2221	2115	2078			
				2255	2115	2127			
				2258	2180	2150			
$\frac{7}{2}^+$	$\Lambda(2020)$	*	$\approx 2020$	2251	2120	2130			
				2471		2331			
$\frac{9}{2}^+$	$\Lambda(2350)$	***	2340-2350	2360		2340			

Table 15: Masses of the negative parity  $\Lambda$  states (in MeV).

$J^P$	Experiment			Theory					
	State	Status	Mass	Our	Capstick Isgur	Loring et al.	Melde et al.	Santopinto Ferretti	Engel et al.
$\frac{1}{2}^-$	$\Lambda(1405)$	****	$1405.1^{(1.3)}_{(1.0)}$	1406	1550	1524	1556	1431	1416(81)
	$\Lambda(1670)$	****	1660-1670	1667	1615	1630	1682	1443	1546(110)
	$\Lambda(1800)$	***	1720-1800	1733	1675	1816	1778	1650	1713(116)
				1927	2015	2011	1732	2075(249)	
			2197	2095	2076		1785		
			2218	2160	2117		1854		
$\frac{3}{2}^-$	$\Lambda(1520)$	****	$1519.5(1.0)$	1549	1545	1508	1556	1431	1751(40)
	$\Lambda(1690)$	****	1685-1690	1693	1645	1662	1682	1443	2203(106)
				1812	1770	1775	1650	2381(87)	
	$\Lambda(2050)$	*	2056(22)	2035	2030	1987		1732	
				2319	2110	2090	1785		
$\Lambda(2325)$	*	$\approx 2325$	2322	2185	2147		1854		
			2392	2230	2259		1928		
			2454	2290	2275		1969		
			2468		2313				
$\frac{5}{2}^-$	$\Lambda(1830)$	****	1810-1830	1861	1775	1828	1778	1785	
				2136	2180	2080			
				2350	2250	2179			
$\frac{7}{2}^-$	$\Lambda(2100)$	****	2090-2100	2097	2150	2090			
				2583	2230	2227			
$\frac{9}{2}^-$				2665		2370			

Table 16: Masses of the positive parity  $\Sigma$  states (in MeV).

$J^P$	Experiment			Theory					
	State	Status	Mass	Our	Capstick Isgur	Loring et al.	Melde et al.	Santopinto Ferretti	Engel et al.
$\frac{1}{2}^+$	$\Sigma$	****	1189.37(7)	1187	1190	1190	1180	1211	1216(15)
	$\Sigma(1660)$	***	1630-1660	1711	1720	1760	1616	1546	2069(74)
	$\Sigma(1770)$	*	$\approx 1770$	1922	1915	1947	1911	1668	2149(66)
	$\Sigma(1880)$	*	$\approx 1880$	1983	1970	2009		1801	2335(63)
				2028	2005	2052			
				2180	2030	2098			
			2292	2105	2138				
			2472	2195					
$\frac{3}{2}^+$	$\Sigma(1385)$	****	1382.80(35)	1381	1370	1411	1389	1334	1471(23)
	$\Sigma(1730)$	*	1727(27)		1920	1896	1865	1439	
	$\Sigma(1840)$	*	$\approx 1840$	1862	1970	1961		1924	2194(81)
	$\Sigma(1940)$	*	1941(18)	2025	2010	2011			2250(79)
	$\Sigma(2080)$	**	$\approx 2080$	2076	2030	2044			2468(67)
				2096	2045	2062			
			2157	2085	2103				
			2186	2115	2112				
$\frac{5}{2}^+$	$\Sigma(1915)$	****	1900-1915	1991	1995	1956		2061	
	$\Sigma(2070)$	*	$\approx 2070$	2062	2030	2027			
				2221	2095	2071			
$\frac{7}{2}^+$	$\Sigma(2030)$	****	2025-2030	2033	2060	2070			
				2470	2125	2161			

Table 17: Masses of the negative parity  $\Sigma$  states (in MeV).

$J^P$	Experiment			Theory					
	State	Status	Mass	Our	Capstick Isgur	Loring et al.	Melde et al.	Santopinto Ferretti	Engel et al.
$\frac{1}{2}^-$	$\Sigma(1620)$	*	$\approx 1620$	1620 <a href="#">1693</a>	1630 1675	1628 1771	1677 1736	1753 1868	1603(38) 1718(58)
	$\Sigma(1750)$	***	1730-1750	1747	1695	1798	1759	1895	1730(34)
	$\Sigma(1900)$	*	1900(21)	2115	2110	2111			2478(104)
	$\Sigma(2000)$	*	$\approx 2000$	2198 <a href="#">2202</a> <a href="#">2289</a> <a href="#">2381</a>	2155 2165 2205 2260	2136 2251 2264 2288			
$\frac{3}{2}^-$	$\Sigma(1580)$	*	$\approx 1580$						
	$\Sigma(1670)$	***	1665-1670	1706 1731	1655 1750	1669 1728	1677 1736	1753 1868	1736(40) 1861(20)
	$\Sigma(1940)$	***	1900-1940	<a href="#">1856</a> 2175 2203 <a href="#">2300</a>	1755 2120 2185 2200	1781 2139 2171 2203	1759	1895	2297(122) 2394(74)
$\frac{5}{2}^-$	$\Sigma(1775)$	****	1770-1775	1757 2214 2347	1755 2205 2250	1770 2174 2226	1736	1753	
$\frac{7}{2}^-$	$\Sigma(2100)$	*	$\approx 2100$	2259 2349	2245	2236 2285			
$\frac{9}{2}^-$				2289		2325			

Table 18: Masses of the positive parity  $\Xi$  states (in MeV).

$J^P$	Experiment			Theory					
	State	Status	Mass	Our	Capstick Isgur	Loring et al.	Melde et al.	Santopinto Ferretti	Engel et al.
$\frac{1}{2}^+$	$\Xi$	****	1321.71(7)	1330	1305	1310	1348	1317	1303(13)
				1886	1840	1876	1805	1772	2178(48)
				1993	2040	2062		1868	2231(44)
				2012	2100	2131		1874	2408(45)
				2091	2130	2176			
				2142	2150	2215			
				2367	2230	2249			
$\frac{3}{2}^+$	$\Xi(1530)$	****	1531.80(32)	1518	1505	1539	1528	1552	1553(18)
				1966	2045	1988		1653	2228(44)
				2100	2065	2076			2398(52)
				2121	2115	2128			2574(52)
				2122	2165	2170			
				2144	2170	2175			
				2149	2210	2219			
				2421	2230	2257			
$\frac{5}{2}^+$				2108	2045	2013			
				2147	2165	2141			
				2213	2230	2197			
$\frac{7}{2}^+$				2189	2180	2169			

Table 19: Masses of the negative parity  $\Xi$  states (in MeV).

$J^P$	Experiment			Theory					
	State	Status	Mass	Our	Capstick Isgur	Loring et al.	Melde et al.	Santopinto Ferretti	Engel et al.
$\frac{1}{2}^-$				1682	1755	1770			1716(43)
				1758	1810	1922			1837(28)
				1839	1835	1938			1844(43)
				2160	2225	2241			2758(78)
				2210	2285	2266			
				2233	2300	2387			
				2261	2320	2411			
$\frac{3}{2}^-$	$\Xi(1820)$	***	1823(5)	1764	1785	1780	1792	1861	1894(38)
				1798	1880	1873		1971	1906(29)
				1904	1895	1924			2426(73)
				2245	2240	2246			2497(61)
				2252	2305	2284			
				2350	2330	2353			
				2352	2340	2384			
$\frac{5}{2}^-$				1853	1900	1955	1881		
				2333	2345	2292			
				2411	2350	2409			
$\frac{7}{2}^-$				2460	2355	2320			
				2474		2425			
$\frac{9}{2}^-$				2502		2505			



Table 20: Fitted parameters  $\alpha$ ,  $\alpha_0$  for the slope and intercept of the  $(J, M^2)$  Regge trajectories of strange baryons.

Baryon	$\alpha$ (GeV <sup>-2</sup> )	$\alpha_0$	Baryon	$\alpha$ (GeV <sup>-2</sup> )	$\alpha_0$
$\Lambda$ ( $\frac{1}{2}^+$ )	$0.923 \pm 0.016$	$-0.648 \pm 0.057$	$\Lambda$ ( $\frac{1}{2}^-$ )	$0.732 \pm 0.018$	$-0.951 \pm 0.074$
$\Sigma$ ( $\frac{1}{2}^+$ )	$0.799 \pm 0.029$	$-0.676 \pm 0.100$	$\Sigma$ ( $\frac{3}{2}^+$ )	$0.897 \pm 0.010$	$-0.225 \pm 0.037$
$\Xi$ ( $\frac{1}{2}^+$ )	$0.694 \pm 0.007$	$-0.721 \pm 0.024$	$\Xi$ ( $\frac{3}{2}^+$ )	$0.769 \pm 0.032$	$-0.249 \pm 0.098$
			$\Omega$ ( $\frac{3}{2}^+$ )	$0.712 \pm 0.002$	$-0.504 \pm 0.007$