

Feasibility Study of $\phi(1020)$ Production at NICA/MPD

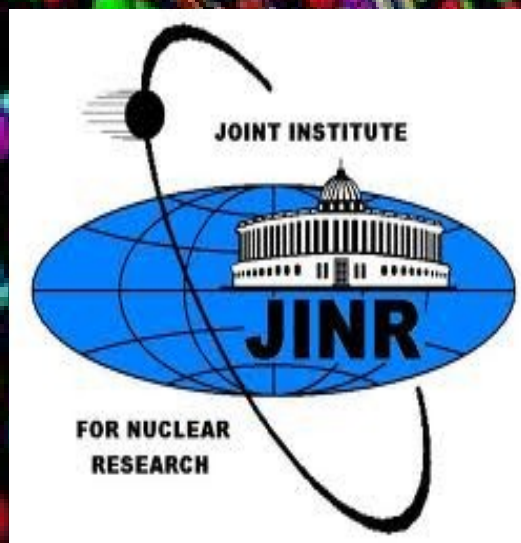

Lyubka Yordanova
VBLHEP, JINR, Dubna, Russia

Conference-school of Young Scientists and Specialists
2-8 June 2014, Alushta, Crimea

Contents:

1. Introduction
2. Multi-Purpose Detector MPD at NICA
3. Motivation for feasibility study of $\phi(1020)$ and tasks
4. UrQMD generator
5. Reconstruction of $\phi(1020)$
6. Results
7. Conclusion

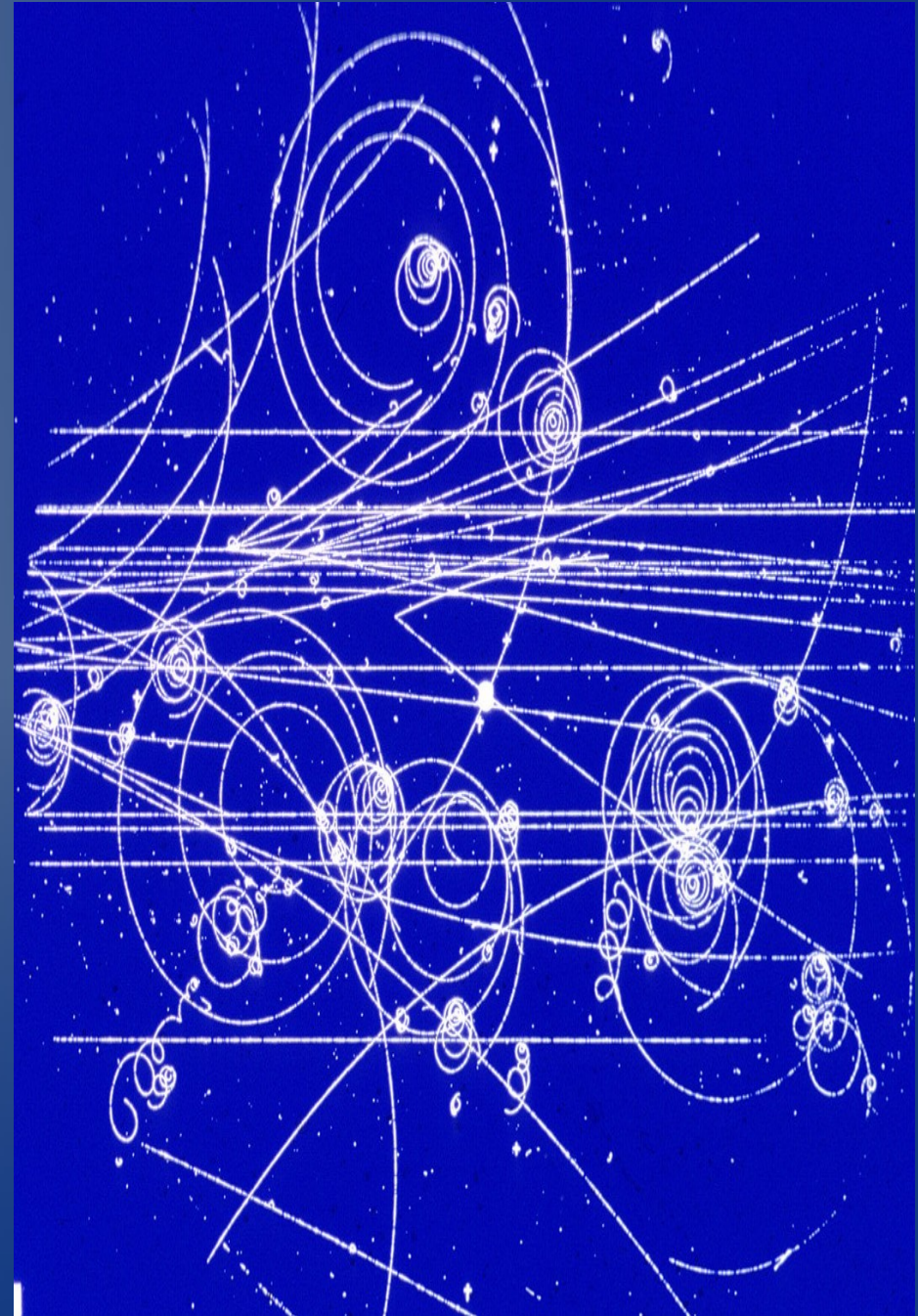

Superconducting accelerator complex **NICA**

(**N**uclotron based **I**on **C**ollider **f**Acility)

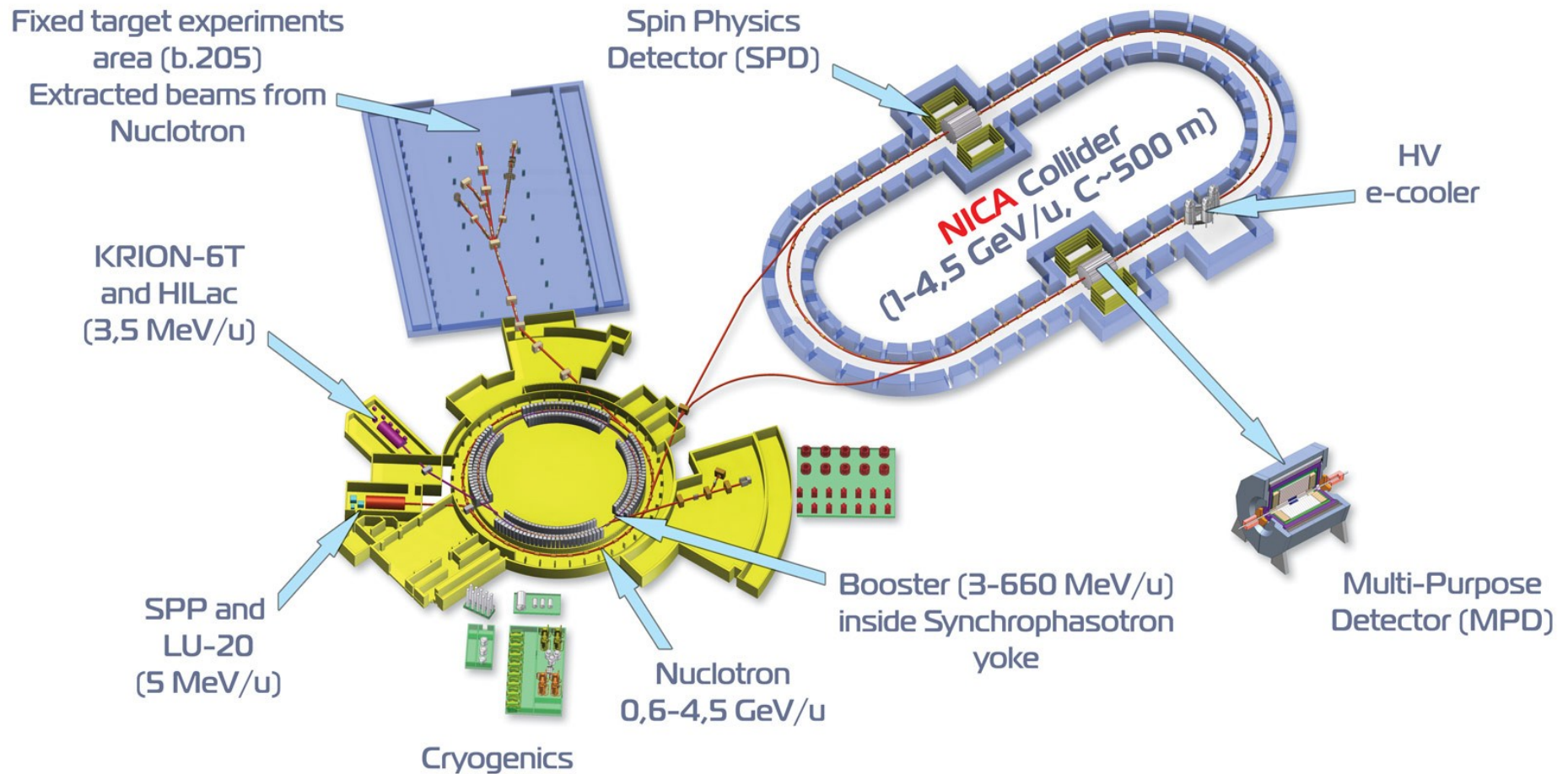

NICA parameters

- ◆ Energy range: $\sqrt{s_{NN}} = 4-11$ GeV
- ◆ Beams : from p to Au
- ◆ Luminosity : $L \sim 10^{27}$ (Au), 10^{32} (p)
- ◆ 2 Detectors: MPD (ions), SPD (spin physics)

Multi-Purpose Detector MPD at NICA

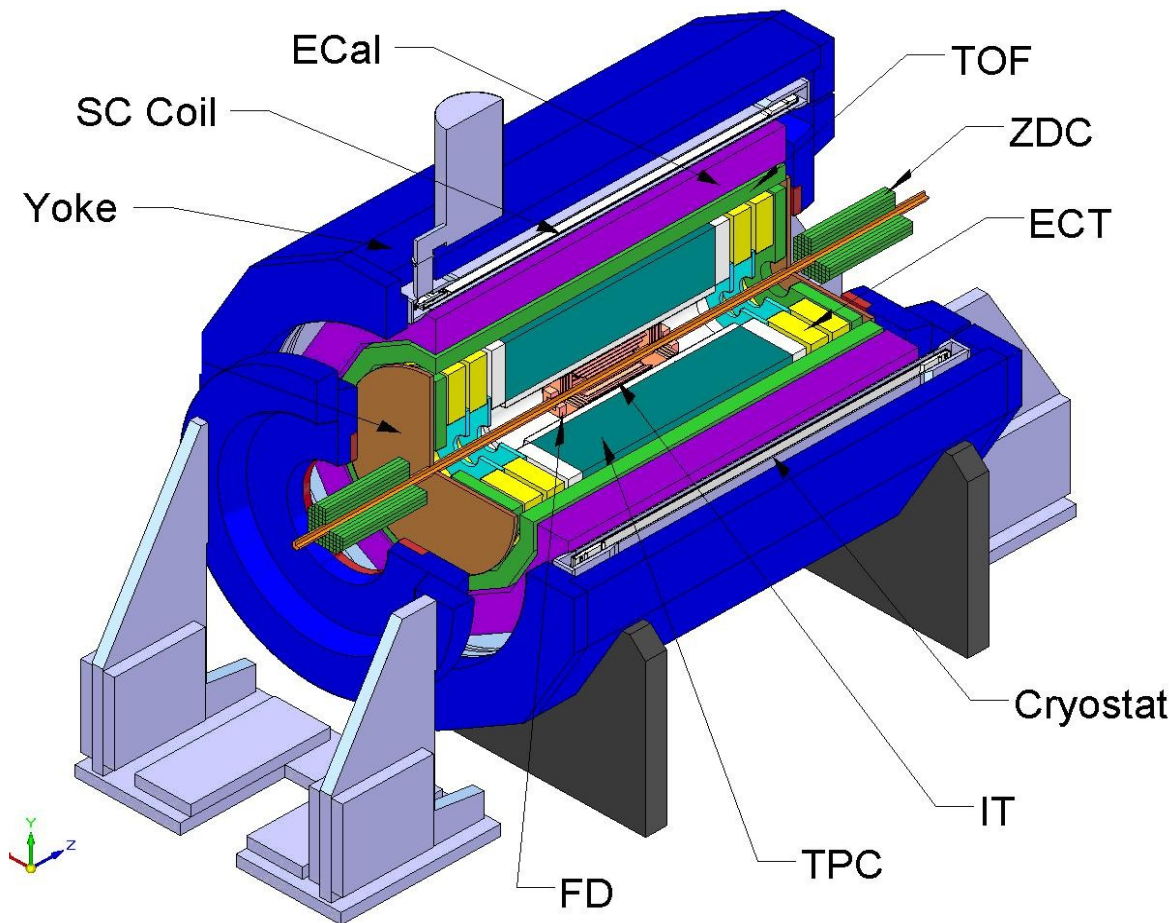

Central Detector

Volume:

9.0 m (Length)

6.6 m (Diameter)

Magnet :

0.5 T superconductor
(1st stage)

Tracking :

TPC (1st stage, $|\eta| < 2.0$)

ECT, IT (2nd stage, $|\eta| < 2.5$)

Particle ID :

TOF, ECal, TPC

(1st stage, $|\eta| < 1.5$)

Triggering : FD

(1st stage, $2.0 < |\eta| < 4.0$)

Centrality : ZDC

(1st stage, $2.2 < |\eta| < 4.8$)

MPD Advantages:

- *Hermeticity, homogenous acceptance (2π in azimuth), low material budget
- *Excellent tracking performance and powerful PID
- *High event rate capability and careful event characterization

Simulation and Analysis Framework for MPD detector

The screenshot shows the MpdRoot website interface. At the top, there is a search bar and a login link. Below the header, there are navigation tabs for 'General', 'Forum', and 'HowTo'. A 'News' section on the left lists various articles. The main content area features a 'Production' menu and a 'detector general view' section. This section contains a 3D cutaway diagram of the MPD detector with labels for various components: ZDC, Yoke Cryostat, ECal, SC Coil, TOF, FS-B, TM, TPC, IT, FD, ECT, BBC, ZDC, DC, and FS-A. A small figure of a person is shown for scale next to the detector.

<http://mpd.jinr.ru>

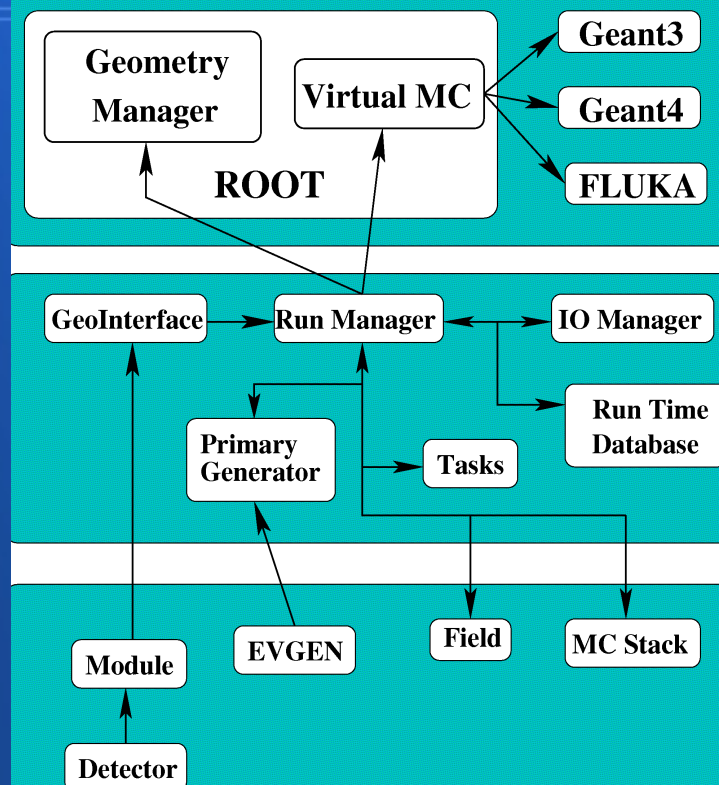

- MpdRoot inherits basic properties from FairRoot (developed at GSI), C++ classes
- Extended set of event generators for heavy ion collisions (UrQMD, LAQGSM, HSD)
- Detector composition and geometry; particle propagation by GEANT3/4
- Advanced detector response functions, realistic tracking and PID included

Motivation for feasibility study of $\phi(1020)$ production at NICA/MPD

- Strangeness as a probe of deconfinement
- Nuclear dynamics and hadron production under extreme nuclear density
- Low cross-section in nuclear matter, early freeze-out
- Particle properties in dense nuclear matter

Challenge - *Low yield of $\phi(1020)$*

Why at NICA/MPD ? - *High luminosity , high efficiency, detector with precise tracking*

Activities:

- 1** Generators of HIC at NICA energies (UrQMD), study of model predictions for particle yields and spectra (K, ϕ)
- 2** Event reconstruction in the MPDRoot framework, study of the MPD particle ID performance for kaons at $\sqrt{s_{NN}} = 11$ GeV
- 3** Development of algorithms for proper reconstruction of ϕ (1020) and solving problems with statistics
- 4** Analysis of invariant mass distributions for identified $K+K^-$ (ϕ) pairs

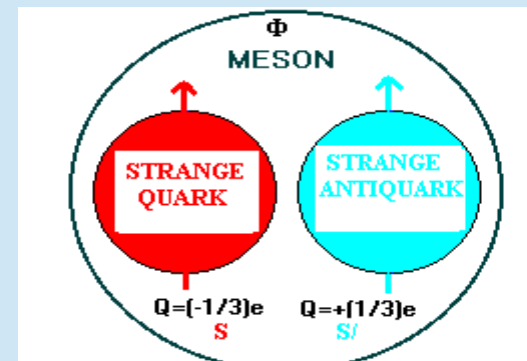

The UrQMD model

The **Ultrarelativistic Quantum Molecular Dynamics model** is a microscopic model used to simulate (ultra)relativistic heavy ion collisions in wide energy range.

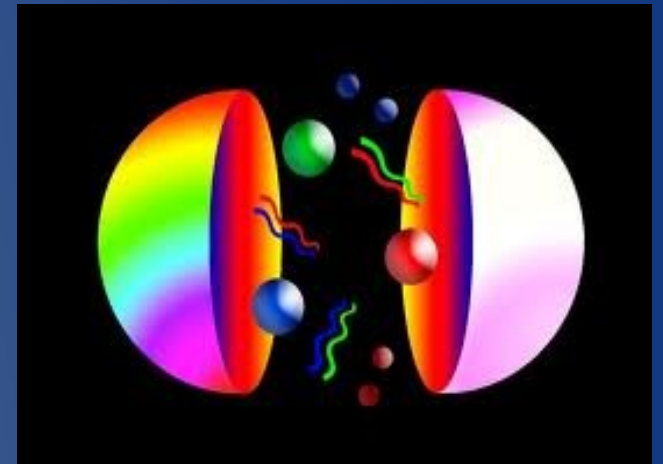
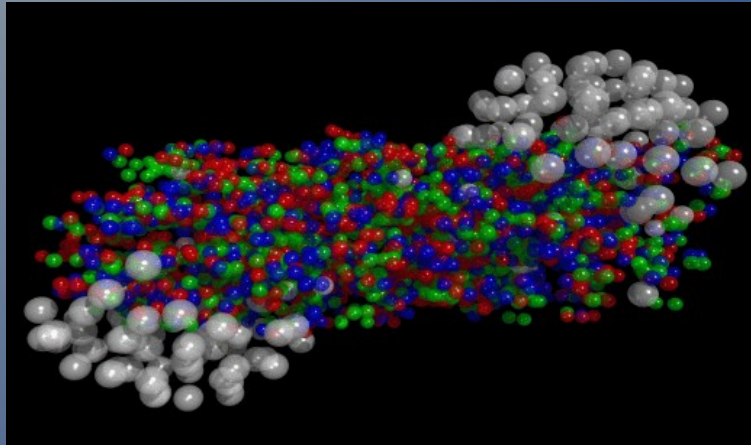

Main goals:

- * Creation of dense hadronic matter at high temperatures
- * Creation of mesonic matter and of anti-matter
- * Creation and transport of rare particles in hadronic matter
- * Creation, modification and destruction of strangeness in matter
- * Emission of electromagnetic probes

Study of model predictions for particle yields and spectra (K, ϕ)

*Phase-space distributions

*Pt spectra – Fit function: $\frac{\partial^2 N}{\partial p_T \partial y} \sim p_T \cdot \exp\left(\frac{-\sqrt{p_T^2 + m^2} - m}{T}\right)$

*Mt spectra – Fit function: $F = A \cdot \exp\left(-\frac{m_T}{T}\right)$

*Y spectra – Fit function: $F = N \cdot \left(\exp\left(-\frac{(y - y_0)^2}{2\sigma^2}\right) + \exp\left(-\frac{(y + y_0^2)}{2\sigma^2}\right)\right)$

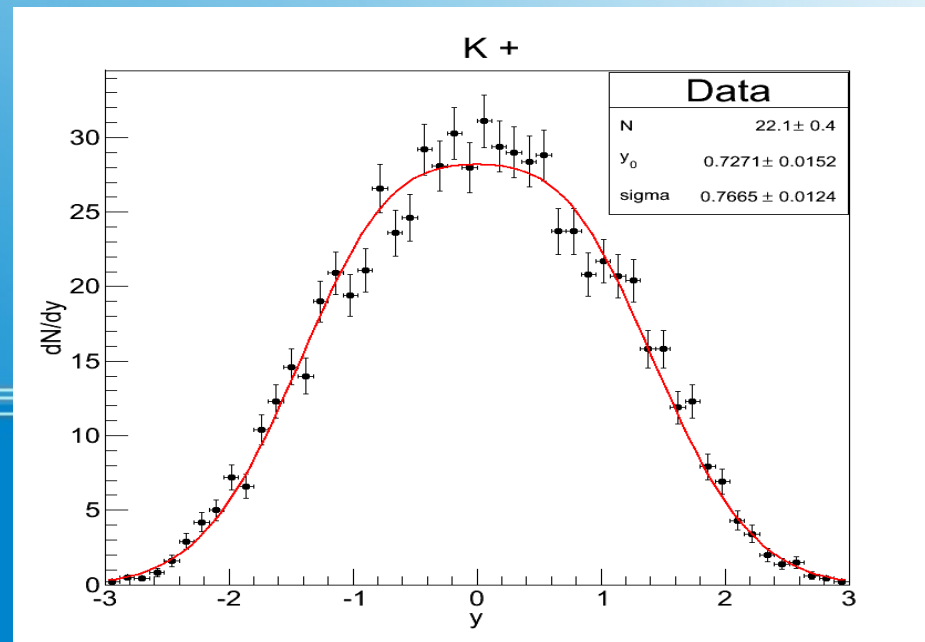
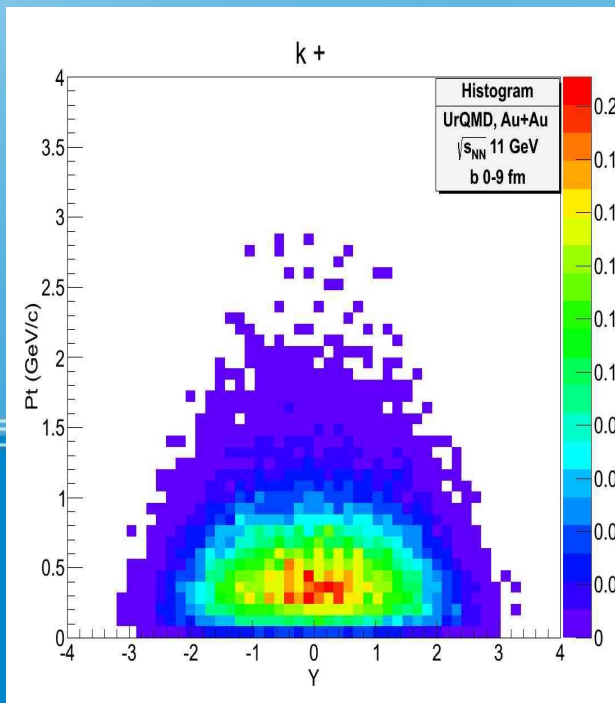

Reconstruction of ϕ (1020)

We use the channel decay $\Phi \rightarrow K^+K^-$ to detect the formation of the ϕ -meson. This channel is chosen because it has a high branching ratio (49.1%) and kaons are easy to detect.

- * UrQMD event generator is used
- * Energy - $\sqrt{s} = 11$ GeV
- * Selection of kaon pairs by track quality cuts and particle identification (PID)

The invariant mass of the kaon pairs is calculated and then the combinatorial background (mixed-event technique) is subtracted. The obtained peak from the invariant mass distribution is then fitted by a Breit-Wigner function and the characteristics of the ϕ -meson such as its mass and its width are found.

$$M_{inv} = \sqrt{((E_1 + E_2)^2 - (p_{x1} + p_{x2})^2 - (p_{y1} + p_{y2})^2 - (p_{z1} + p_{z2})^2)}$$

Reconstruction of ϕ (1020) Signal Distributions

Signal distribution – BOX generator

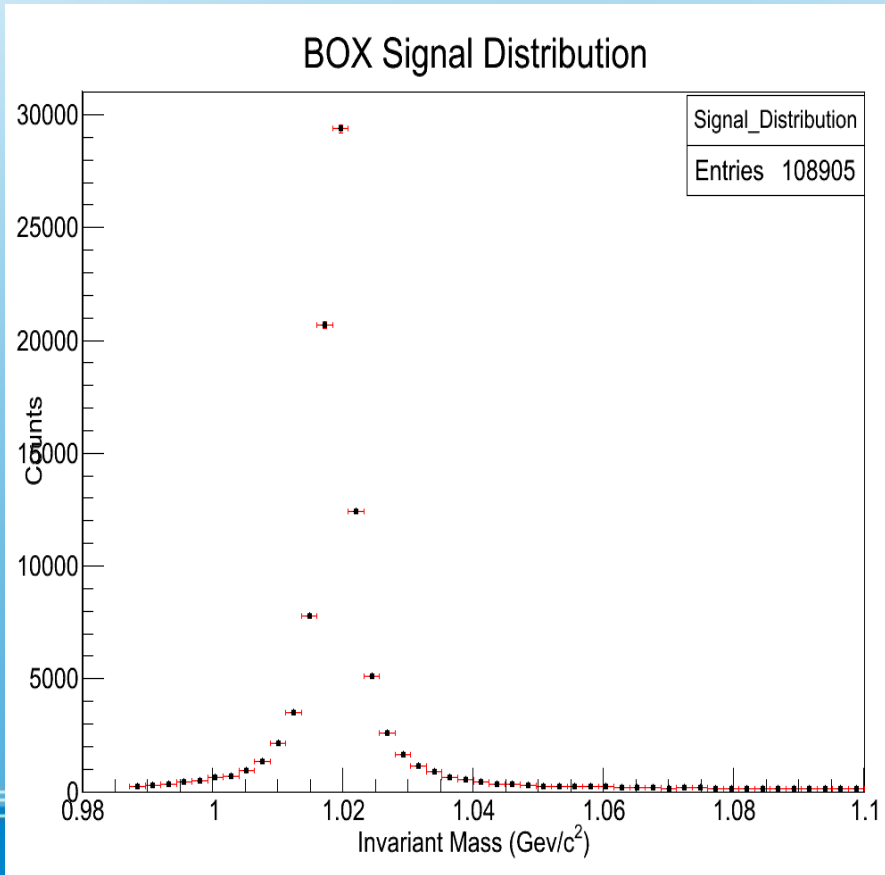

Signal distribution – UrQMD + BOX

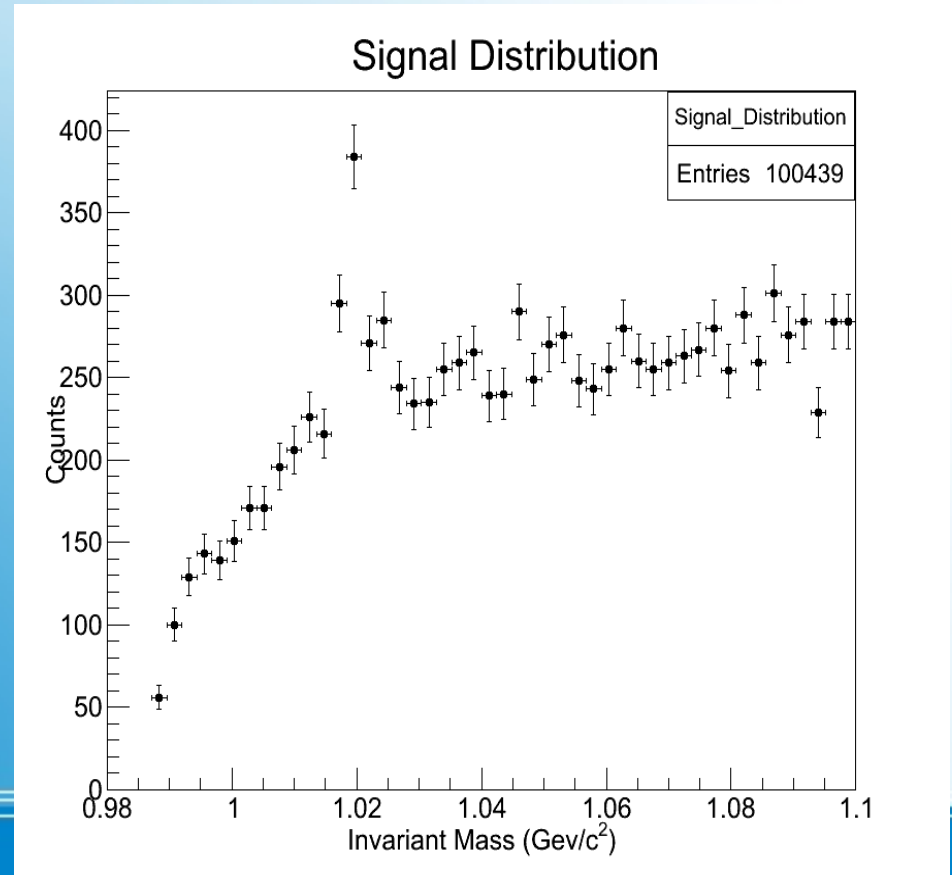

Reconstruction of ϕ (1020) Combinatorial Background

Combinatorial background-same events

Combinatorial background-different events

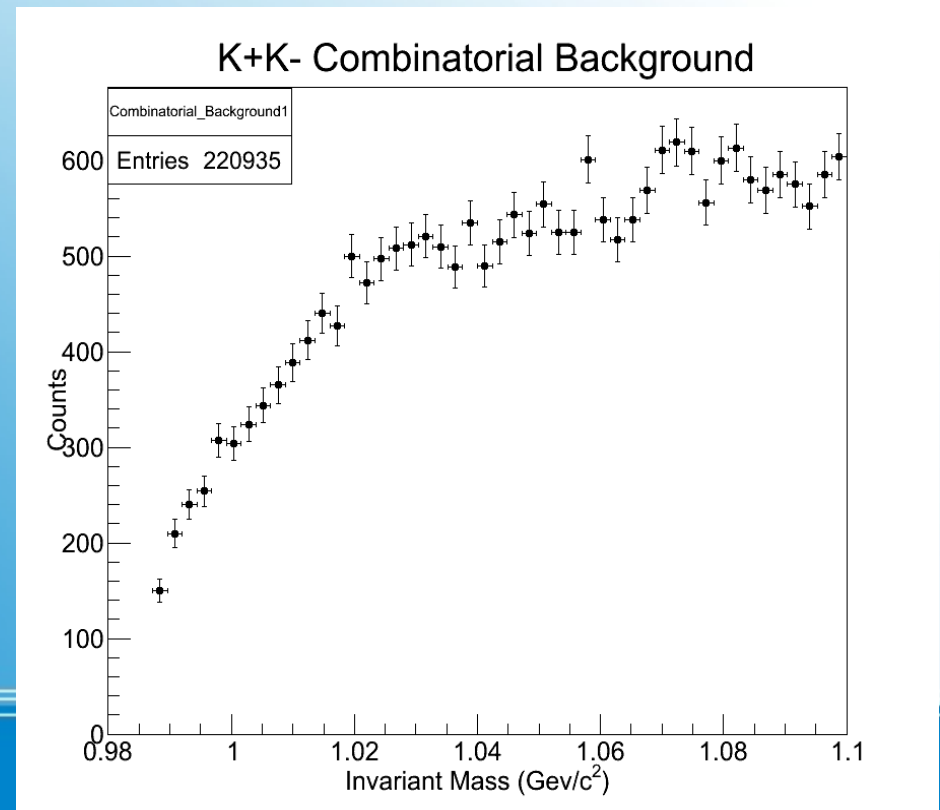
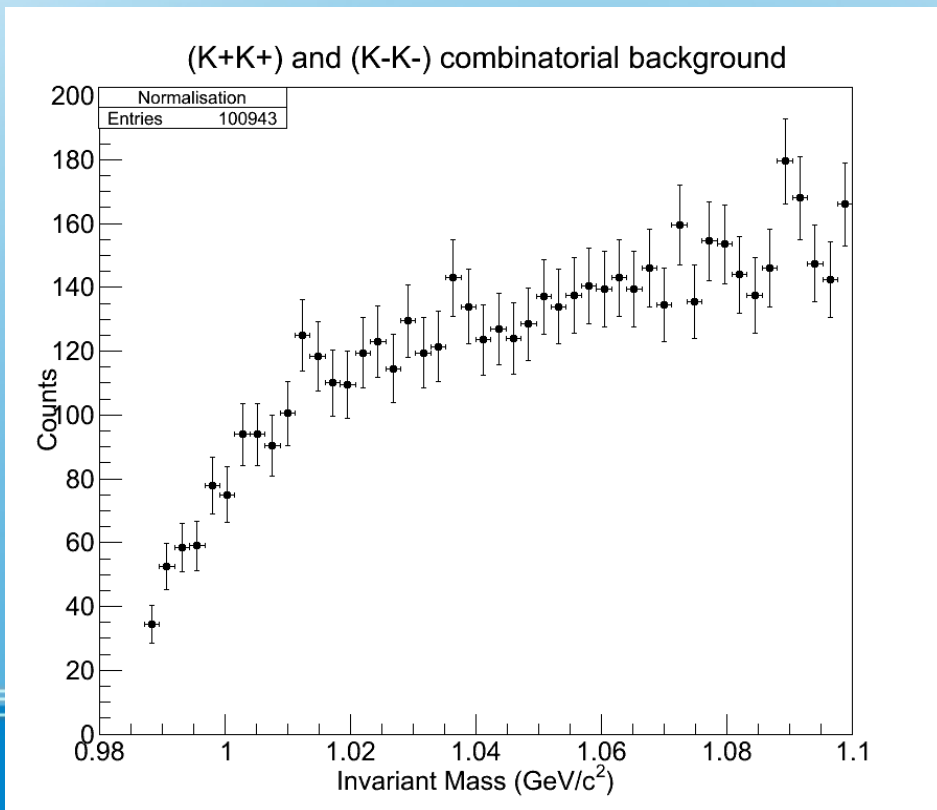

Reconstruction of ϕ (1020)

Signal distribution after subtraction of background

Subtraction of same-event background

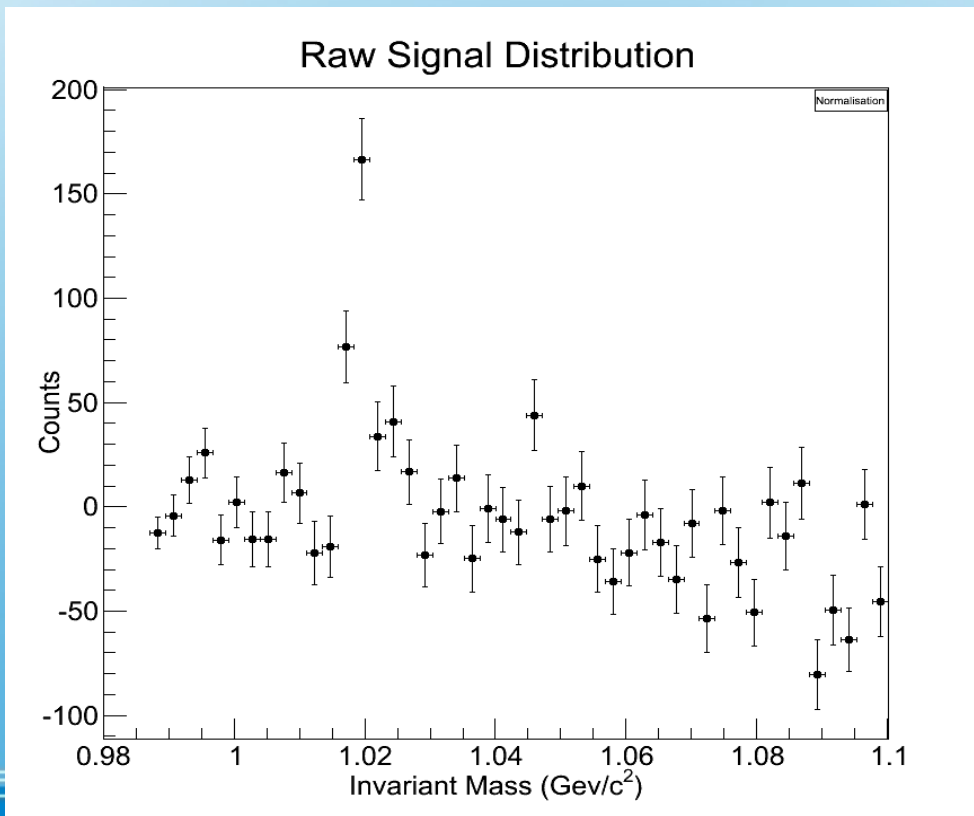

Subtraction of mixed-event background

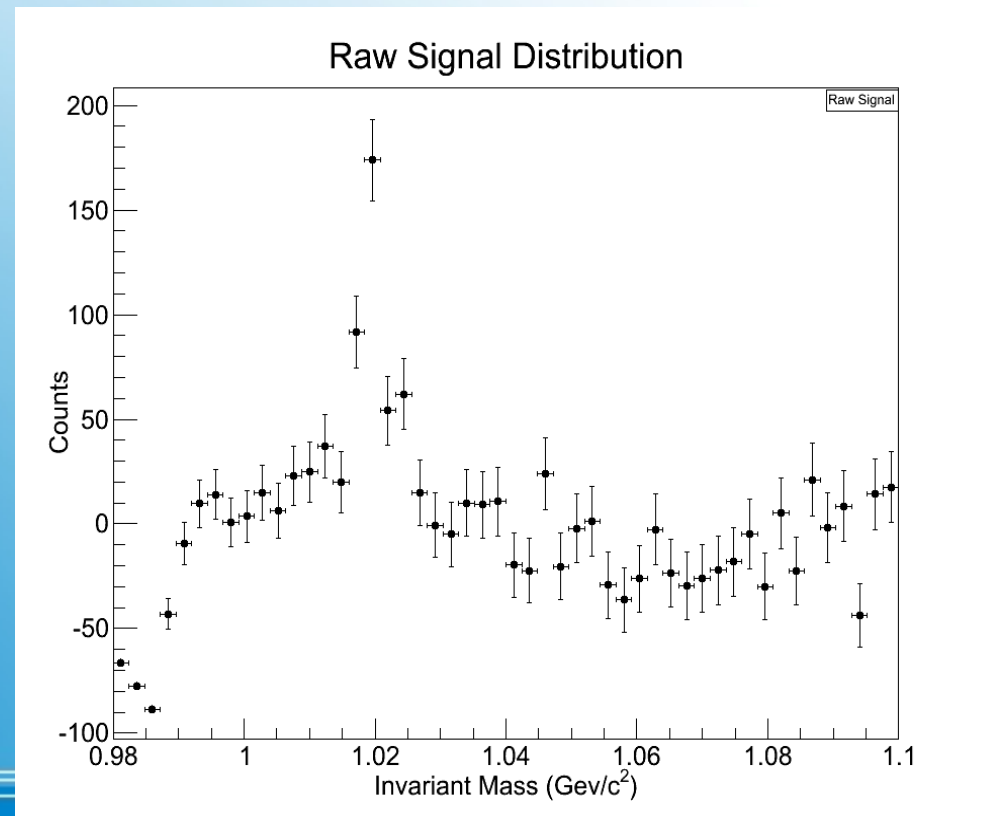

Reconstruction of ϕ (1020) Invariant Mass Distribution Results

Analysis

- *Channel of decay: $\phi \rightarrow K^+K^-$
- *Same-event invariant mass distribution
- *Usage of mixed-event background
- *Breit-Wigner fit function
- *Central Au+Au at $\sqrt{s} = 11$ GeV (UrQMD model)
- *PID: TOF, dE/dx
- *Selection by track quality cuts and PID

BW Width = 0.004291 ± 0.000104 (GeV/c²)
 $M_{inv} = 1.019540 \pm 0.000012$ (GeV/c²)
 $S/\sqrt{(S+B)} = 18.11$

$$M_{inv} = \sqrt{((E_1 + E_2)^2 - (p_{x1} + p_{x2})^2 - (p_{y1} + p_{y2})^2 - (p_{z1} + p_{z2})^2)}$$

$$BW(m_{inv}) = \frac{1}{2\pi} \frac{A \cdot W}{(m - m_\phi)^2 + (W/2)^2}$$

Same-event invariant mass distribution

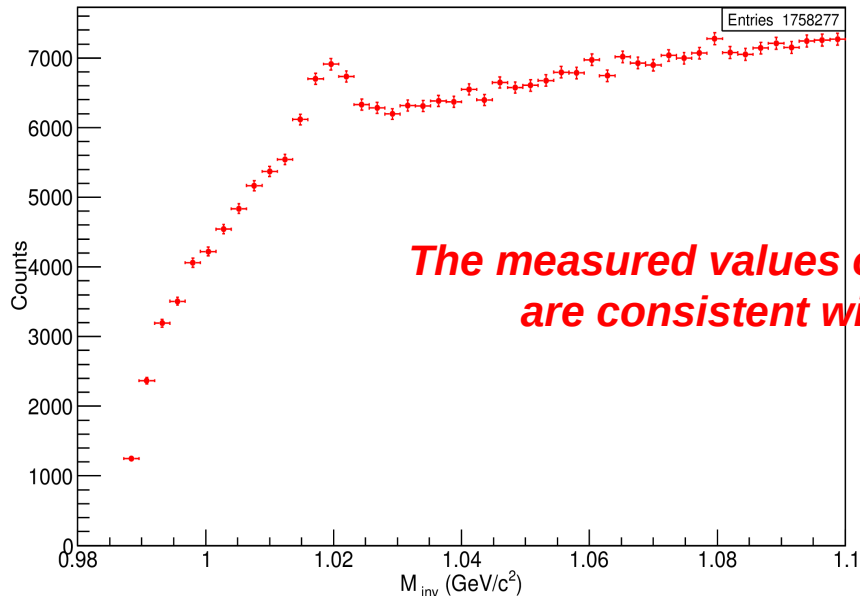

The measured values of the ϕ mass and width are consistent with the PDG values

M_{inv} distribution after subtraction of the mixed-event background

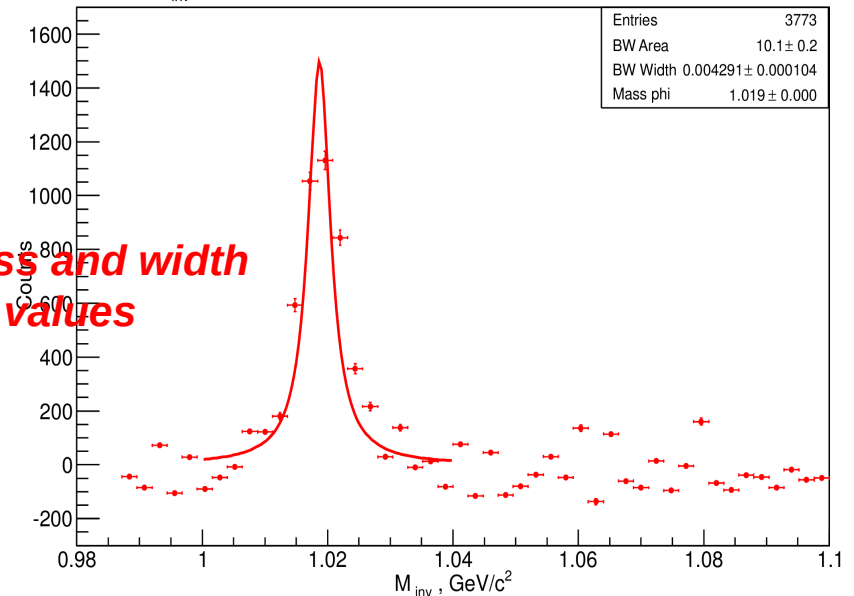

Conclusion

Measurements of the production of strange particles such as the ϕ -meson can provide important information on the properties of the medium and particle production mechanisms in ultra-relativistic Au-Au collisions.

Measurements of the ϕ -meson p_T spectra and their dependence in terms of shape and normalization on centrality may shed light on the constituents of the medium at the time of ϕ formation as well as the mechanism through which the ϕ -mesons are formed. Since multistrange hadrons and particles with hidden strangeness are assumed to freeze out early and undergo fewer interactions in the hadronic stage, their v_2 signals should provide a clean signal from the early stage of the system's evolution.

The recent results of the ϕ -meson study are shown in this presentation. The values of the parameters obtained by the fit are consistent with the values given in literature. This study shows that the measurement of ϕ -mesons is feasible and we can expect detection of them when NICA/MPD will be put in operation.





**Thank you for your
attention!**